

## DESY FEL Seminar 2017-06-27

### Status of Optics Setup & Consolidation at FLASH

#### (Pt.3)

Johann Zemella (MPY) & Mathias Vogt (MFL)

- New FLASH Optics for > August 2017...
- ...for FLASH1, FLASH2 & FLASH3
- More Possible Modifications
- Summary of Pt.3



## FLASH1 Optics: “Fairly Mature”

- last real modification ( $\sim$  2014):
- FL2EXTR (kicker bump, horizontal waist for septum,...)
- ACC4567 : FODO optics
- undulator is FODO since ages !  
(was doublet initially)

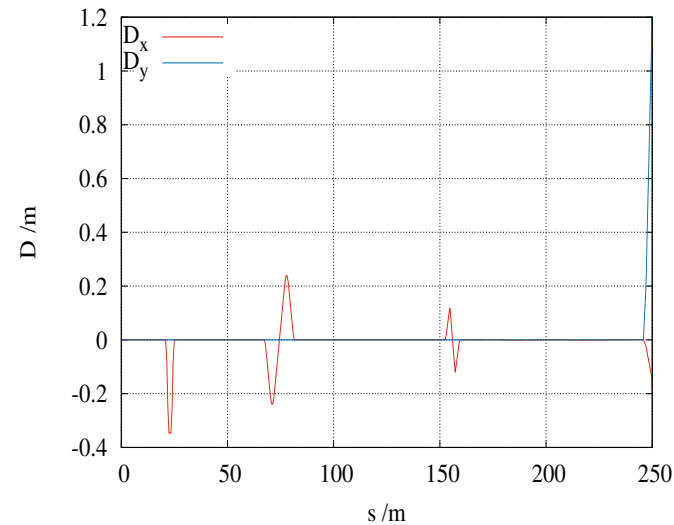
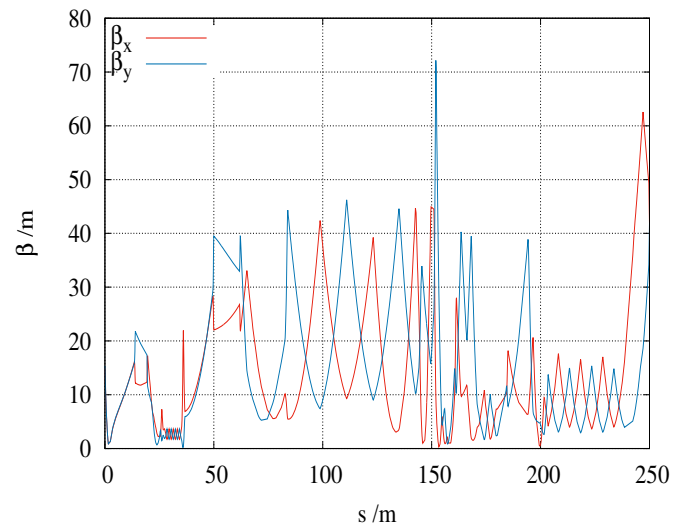

- UBC2 changes : not yet needed
- next (January) shutdown
- Undulator optics needs adaption at low  $E$
- not shown here...

## **FLASH2** Optics: **FL3EXTR** Built In

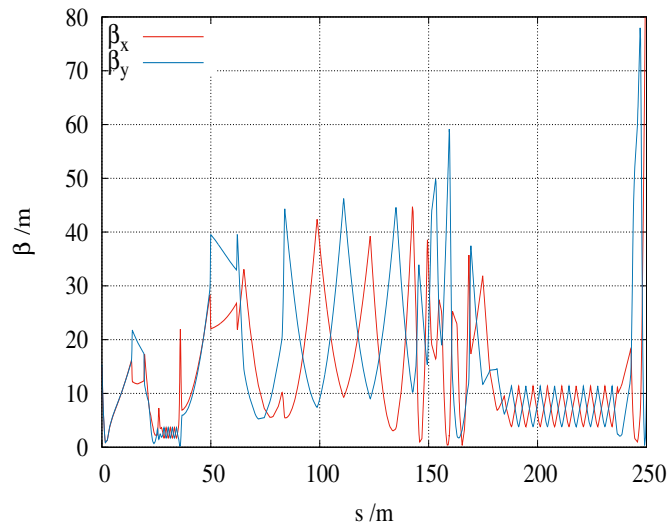

- **M.Scholz & J.Zemella**
  - Must be well established :  
otherwise  $\rightarrow$  apertures critical (losses !!!)
  - FL3EXTR built in now
- $\rightarrow$  see next slide  $\rightarrow$

- more mods to come sooner or later:
  - $\rightarrow$  FL2BC ???
  - $\rightarrow$  afterburner at **FLASH2** (?)
  - $\rightarrow$  XTDS at **FLASH2** (!)
  - $\rightarrow$  THz at **FLASH2**

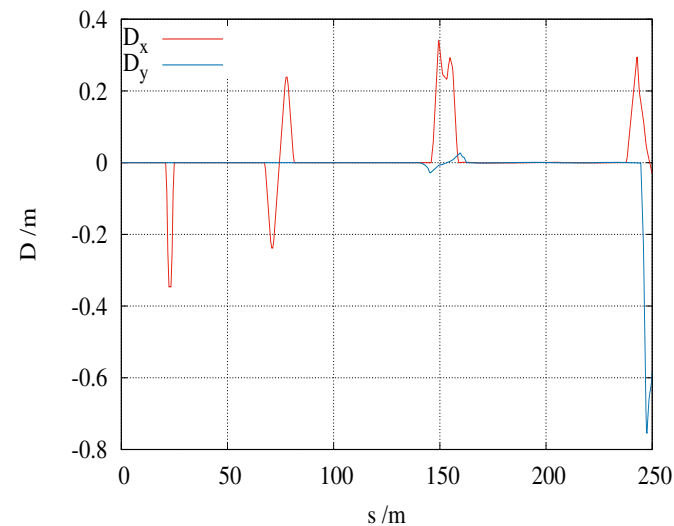

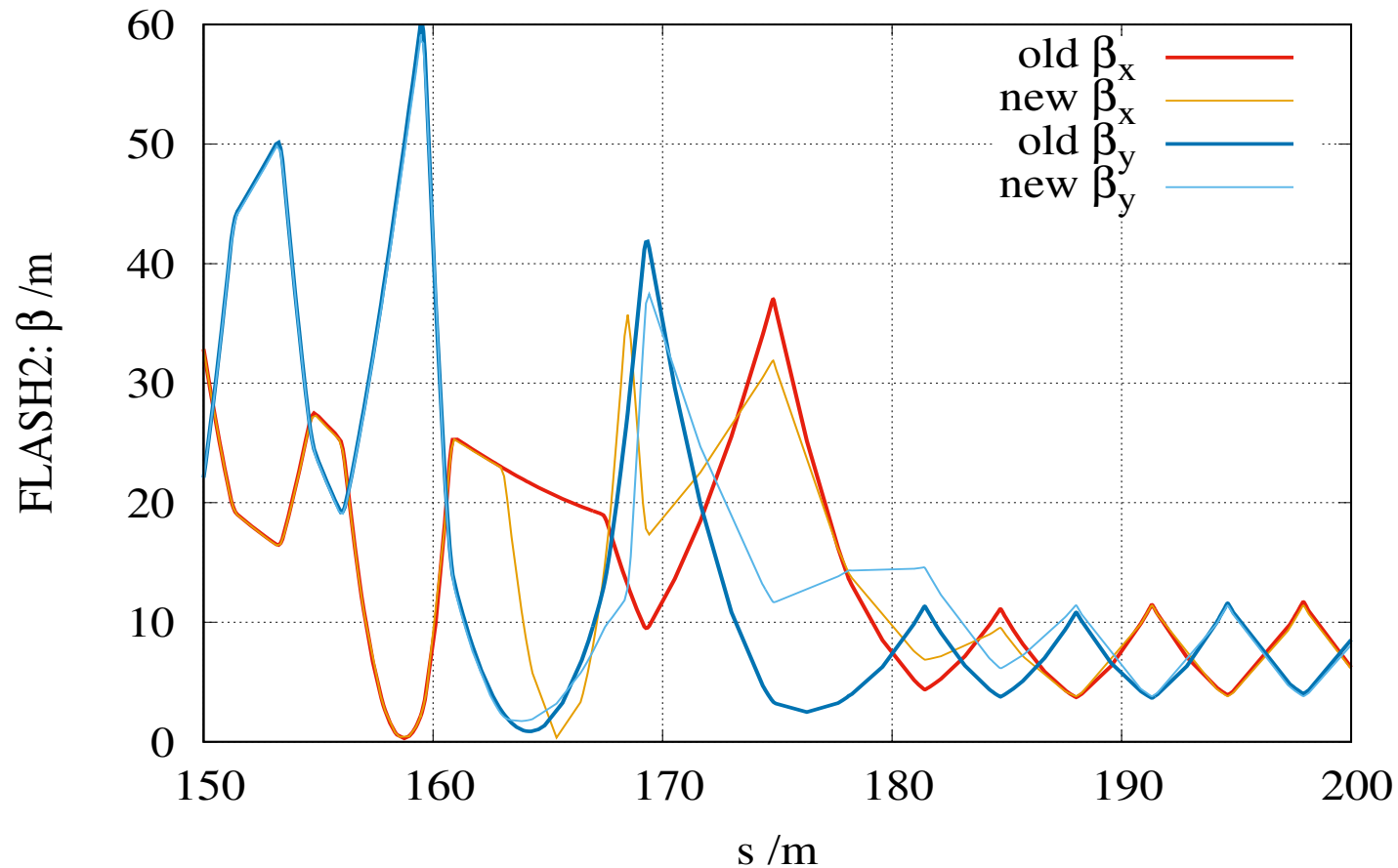
**FLASH2** Optics: Diff: Old=w/o and New=w/ **FL3EXTR**

New: Q17FL2EXTR & Q23FL2EXTR  $\neq 0$  / changes 'till Q3FL2SEED5.  
 Same for BZ's (HERA-p) or "KnallMagnetten" (= Killer & Murder One)

## FLASH3 Optics: **New**

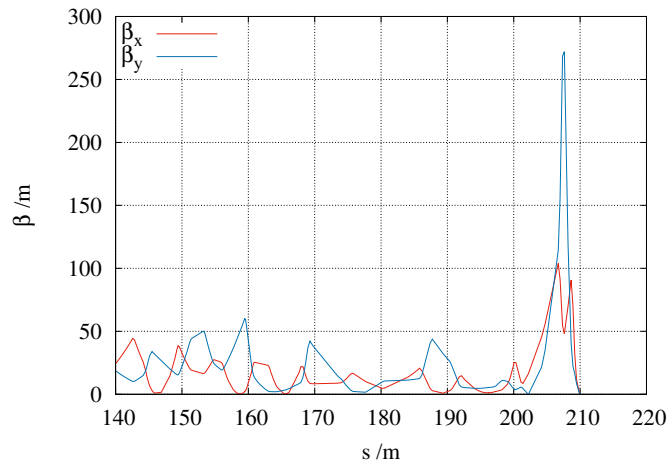
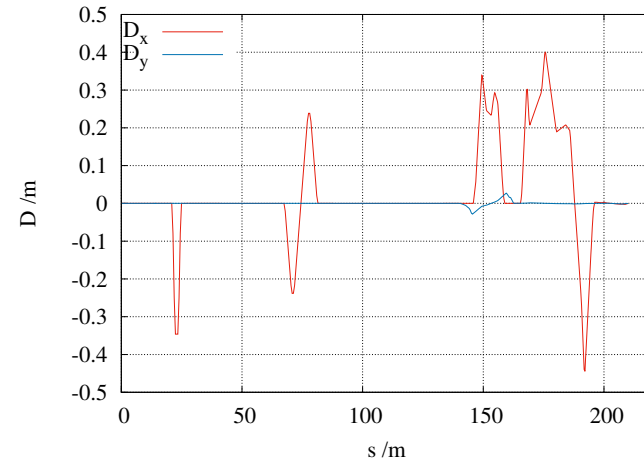
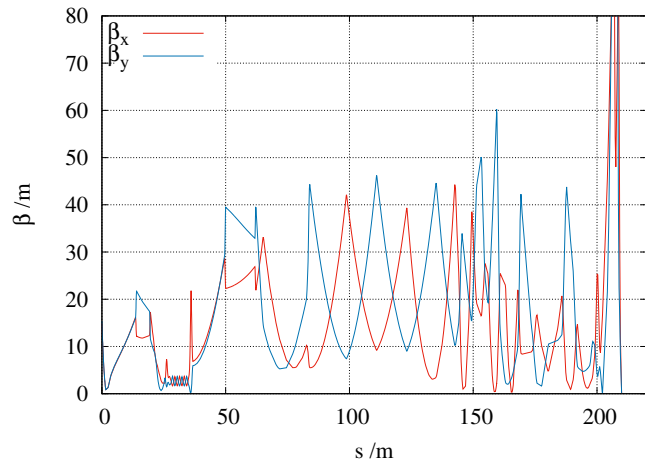

- **Thank to Chr. Behrens!**
  - For **FLASH-Forward**
  - at plasma cell:  $\beta_x / \beta_y = 2.5 / 3.5$  cm
  - so far exists only until plasma cell!
- will need some commissioning

## (Near) Future FLASH

- NC (BAM) FB cavity in UBC2 → new optics
- FL2BC ??
- downstream FL2SASE : afterburner, XTDS, THz
- FLASH-Forward beamline to XTDS & dump

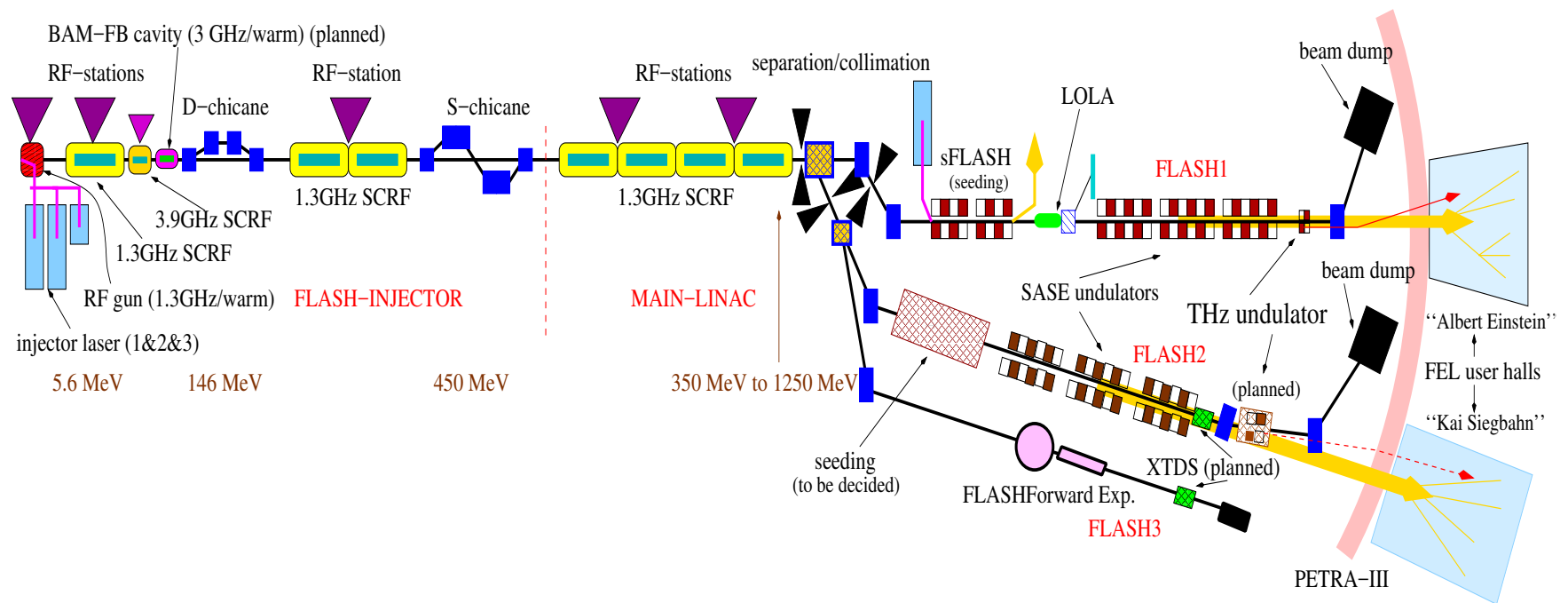

## Summary of Pt.3

- Post 2017–Summer–Shutdown:
  - section FL2EXTR changed to host FL3EXTR
  - new beam line FLASH3 (FLASH–Fwd experiment)
- Post 2018–Winter–Shutdown:
  - NC BAM FB cavity UBC2 ⇒
  - new improved optics UBC2  
(optics exists!, not shown here!, →similar seminar later this/next year?)
- Later: modifications for
  - FL2BC (?) (work in progress)
  - FL2 afterburner (?) (not yet started)
  - FL2 XTDS (optics exists!, not shown here!, →similar seminar later this/next year?)
  - FL2 THz undulator  
(optics exists!, not shown here!, →similar seminar later this/next year?)

**Veelen Dank og för't Tohör'n!**

**— Og in'n Nomen vun mien Kollegen!**