

Simulation Results of Microbunching Instability with Velocity Bunched Beam on the FLASH

FEL Beam Dynamics Meeting
July 23, 2007

Donghoon Kuk (MPY)

donghoonkuk@gmail.com

Contents

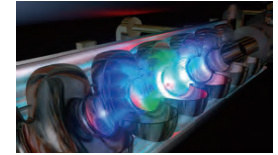

1. GlueTrack
2. Velocity bunching phase(ϕ_2) scan
3. BC2 dipole magnet curvature bending radius scan
4. BC3 dipole magnet curvature bending radius scan
5. Conclusion

GlueTrack

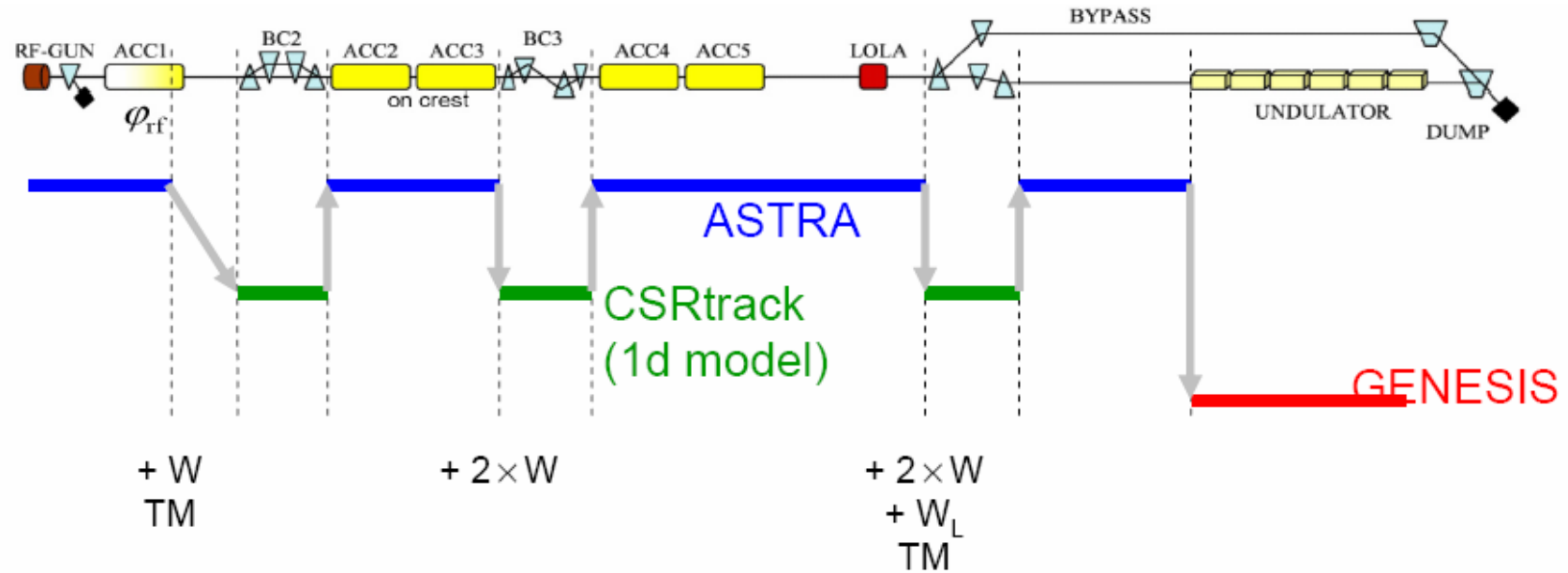
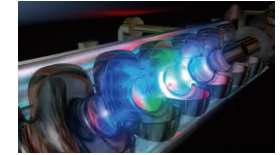

W = wake of one TTF module
 W_L = wake of LOLA structure
 TM = transverse matching to design optic

Igor Zagorodnov - GlueTrack Interpreter for S2E Beam Dynamic Simulations
 Jan 23, 2006

Velocity Bunching Phase Scan

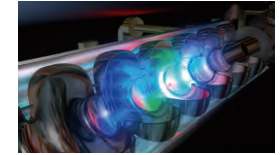

- Velocity bunching phase scan (ACC1)

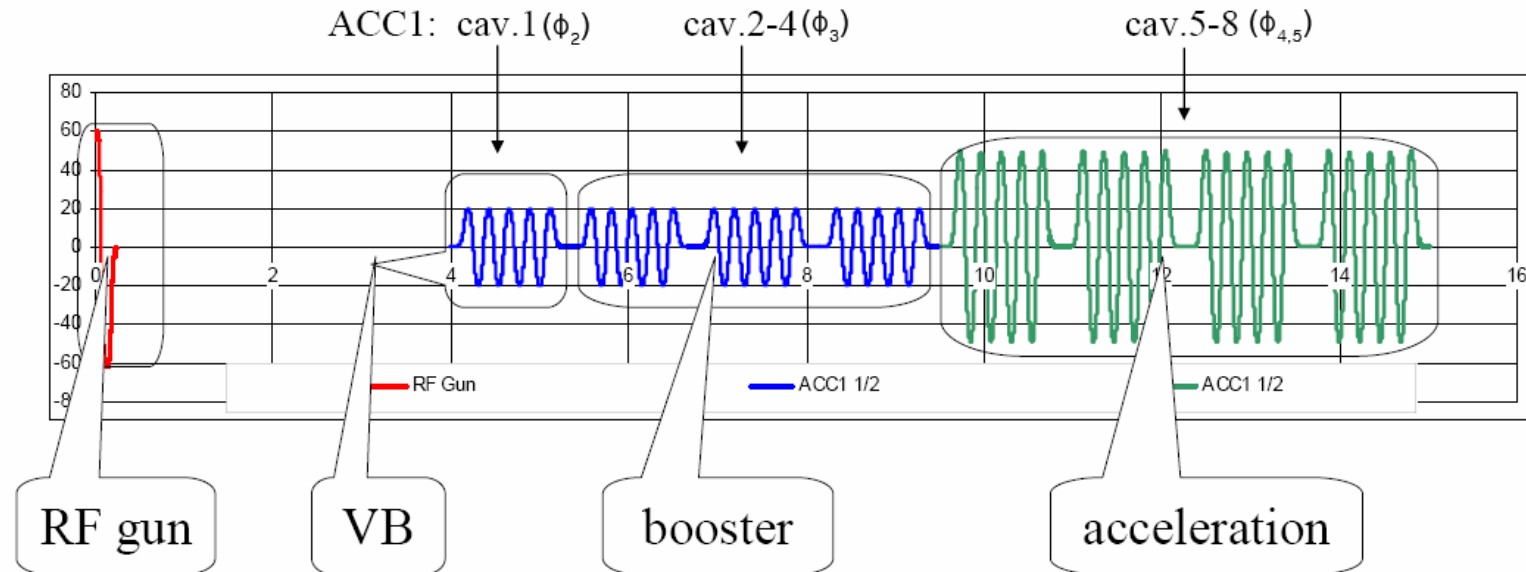

From Mikhail Krasilnikov

ϕ_1	ϕ_2	ϕ_3	ϕ_4	ϕ_5
-0.5501° (flat-top)	-90.00° $\sim -105.00^\circ$	0°	-8.667°	-8.667°

Velocity Bunching Phase Scan

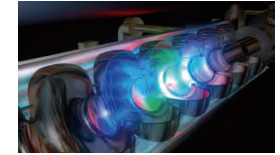

- Phi2 Scan (-90° ~ -105 °)

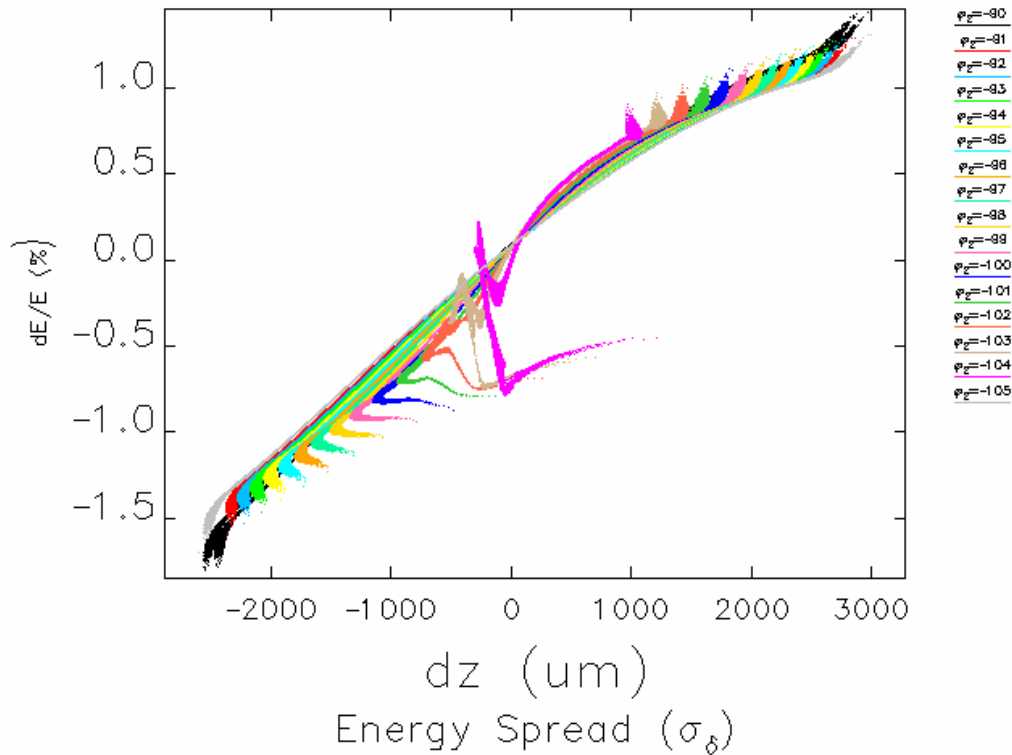

At the End of ACC1

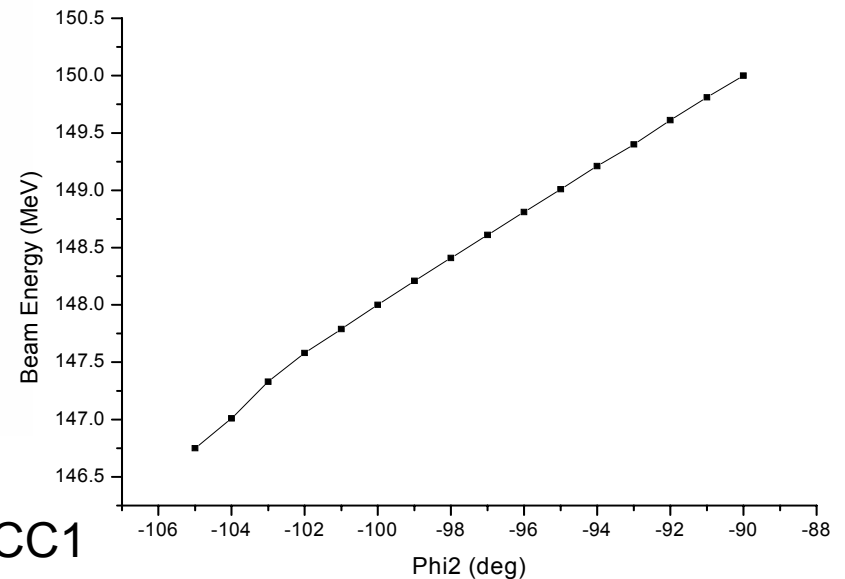
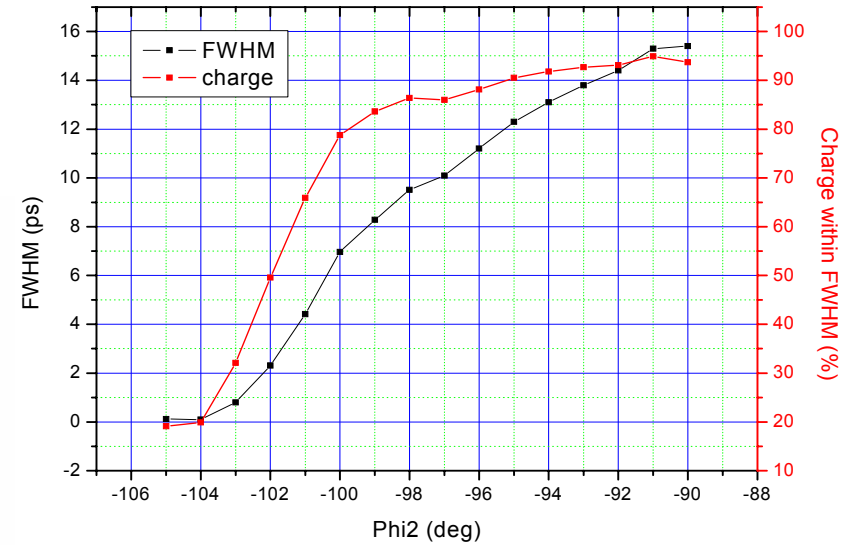

Velocity Bunching Phase Scan

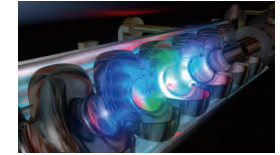

- Selected $\phi_2 = -98^\circ$

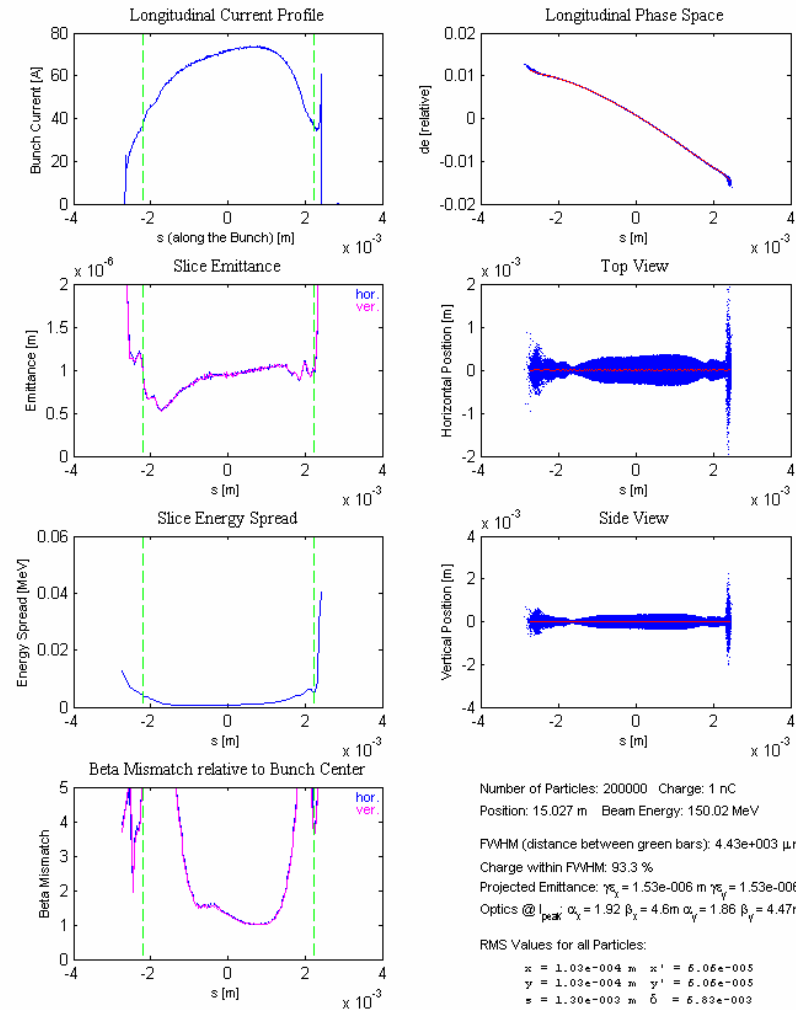
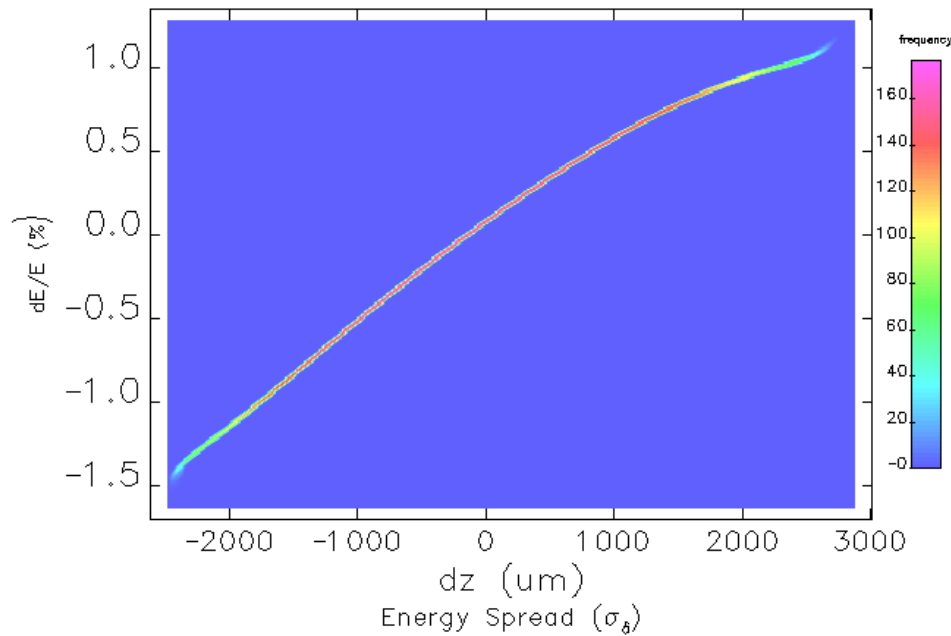

Number of Particles: 200000 Charge: 1 nC
 Position: 15.027 m Beam Energy: 150.02 MeV

FWHM (distance between green bars): 4.43e+003 μm (14.8 ps)
 Charge within FWHM: 93.3 %
 Projected Emittance: $\gamma_x = 1.53\text{e-}006$ m $\gamma_y = 1.53\text{e-}006$ m
 Optics @ L_{peak} : $\alpha_x = 1.92$ $\beta_x = 4.6$ m $\alpha_y = 1.86$ $\beta_y = 4.47$ m

RMS Values for all Particles:

$x = 1.02\text{e-}004$ m	$x' = 6.06\text{e-}005$
$y = 1.02\text{e-}004$ m	$y' = 6.06\text{e-}005$
$s = 1.30\text{e-}003$ m	$\delta = 6.83\text{e-}003$

RMS Values within FWHM:

$x = 9.54\text{e-}005$ m	$x' = 6.04\text{e-}005$
$y = 9.54\text{e-}005$ m	$y' = 6.04\text{e-}005$
$s = 1.19\text{e-}003$ m	$\delta = 6.35\text{e-}003$

BC2 Scan

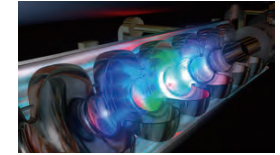

BC2 (m)	BC3 (m)
2.524955	3.60
	3.80
	4.00
	4.20
	4.40
2.544955	3.60
	3.80
	4.00
	4.20
	4.40
2.564955	3.60
	3.80
	4.00
	4.20
	4.40
2.584955	3.60
	3.80
	4.00
	4.20
	4.40
2.604955	3.60
	3.80
	4.00
	4.20
	4.40

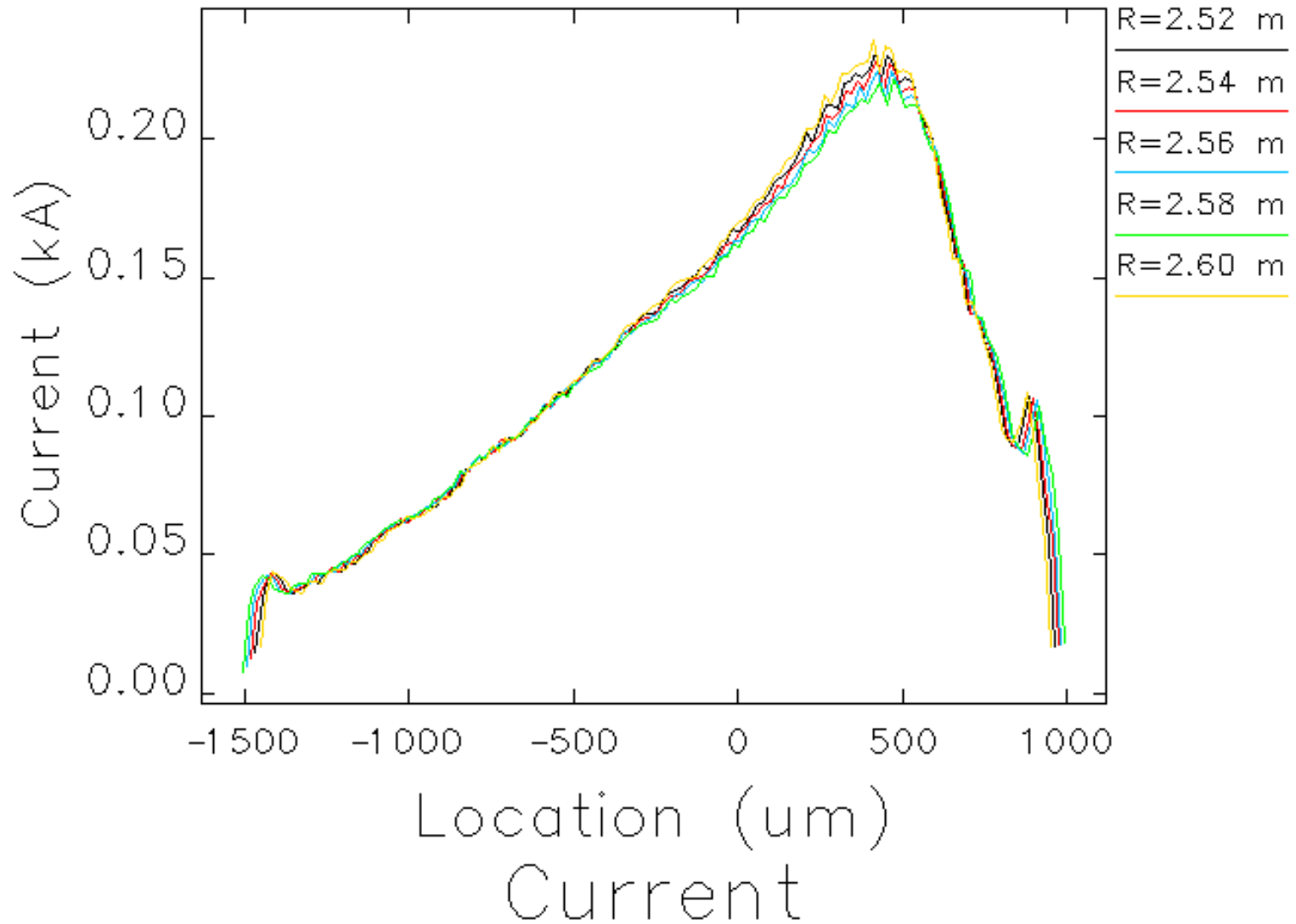

BC3 Scan (type1)

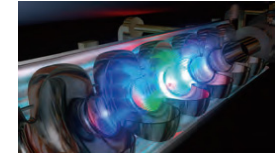

BC2 (m)	BC3 (m)
2.524955	3.60
	3.80
	4.00
	4.20
	4.40
2.544955	3.60
	3.80
	4.00
	4.20
	4.40
2.564955	3.60
	3.80
	4.00
	4.20
	4.40
2.584955	3.60
	3.80
	4.00
	4.20
	4.40
2.604955	3.60
	3.80
	4.00
	4.20
	4.40

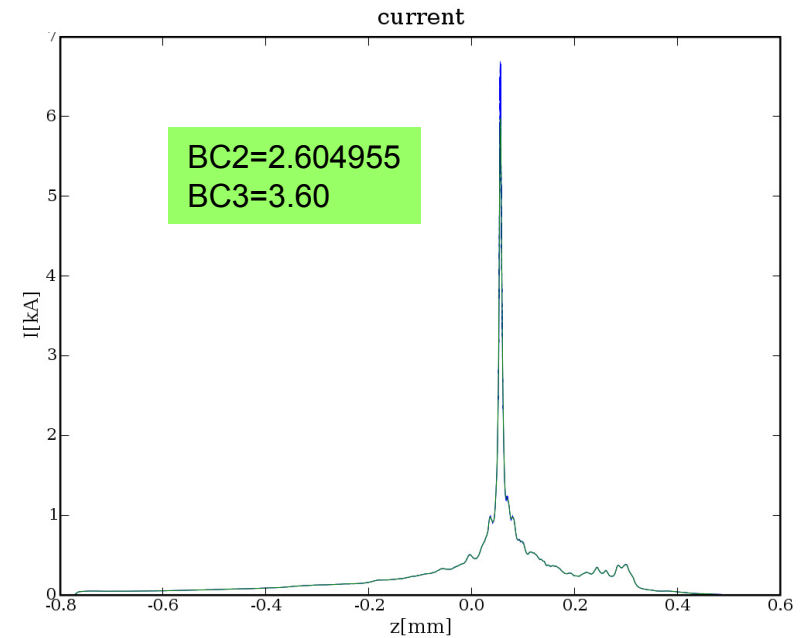
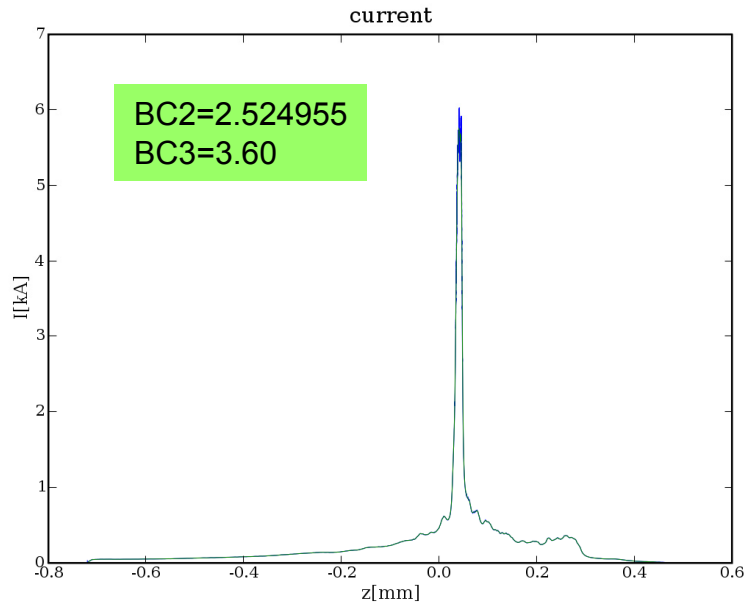

BC3 Scan (type2)

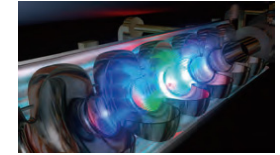

BC2 (m)	BC3 (m)
2.524955	3.60
	3.80
	4.00
	4.20
	4.40
2.544955	3.60
	3.80
	4.00
	4.20
	4.40
2.564955	3.60
	3.80
	4.00
	4.20
	4.40
2.584955	3.60
	3.80
	4.00
	4.20
	4.40
2.604955	3.60
	3.80
	4.00
	4.20
	4.40

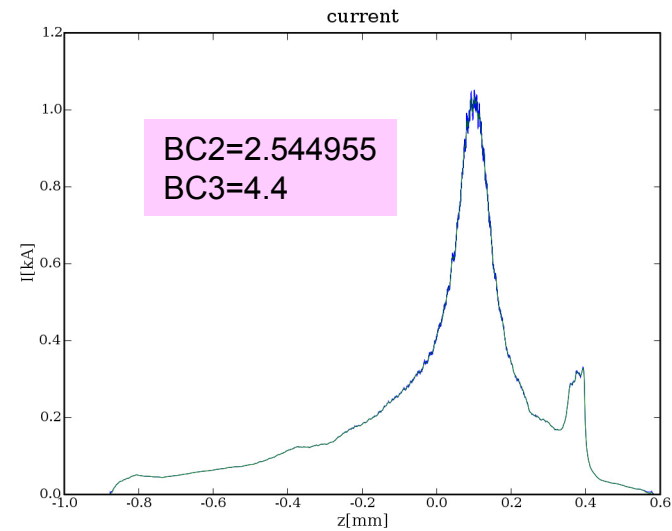
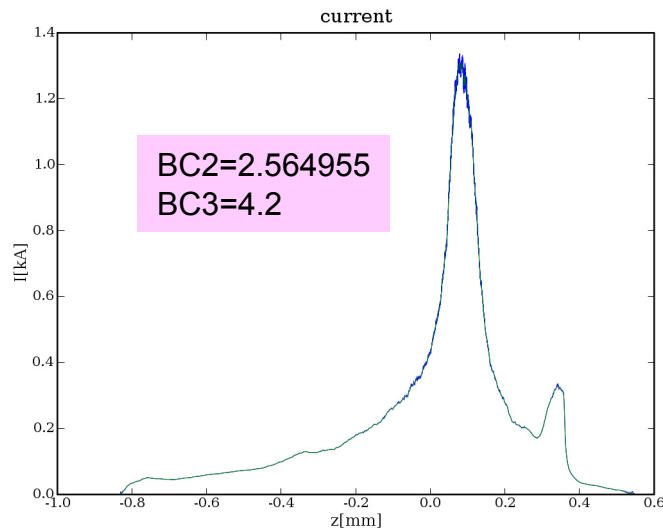
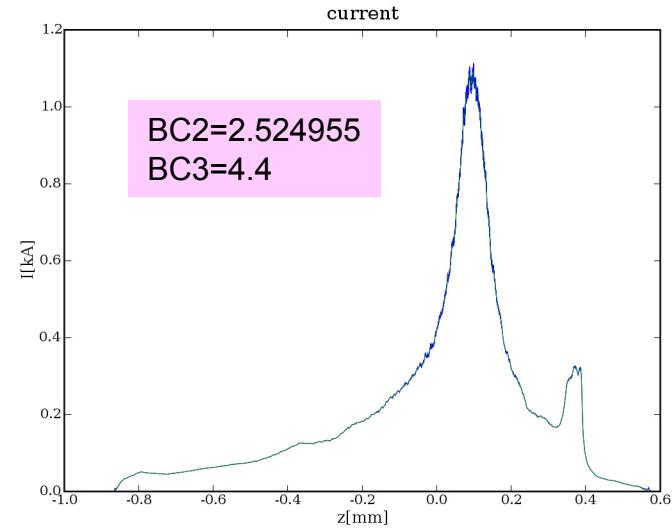
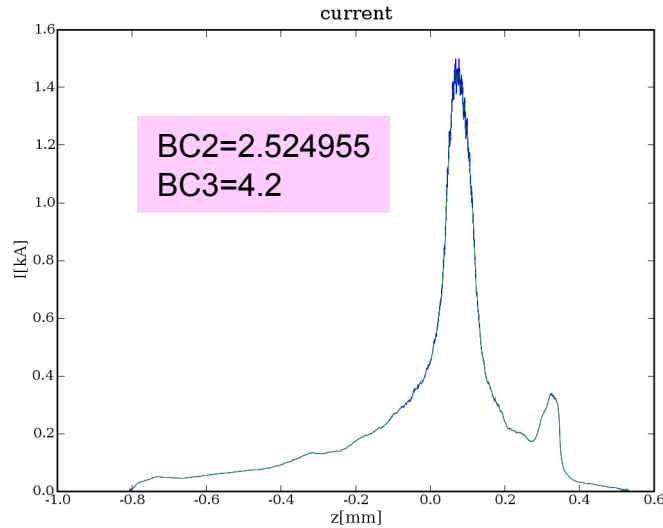

BC3 Scan (type2)

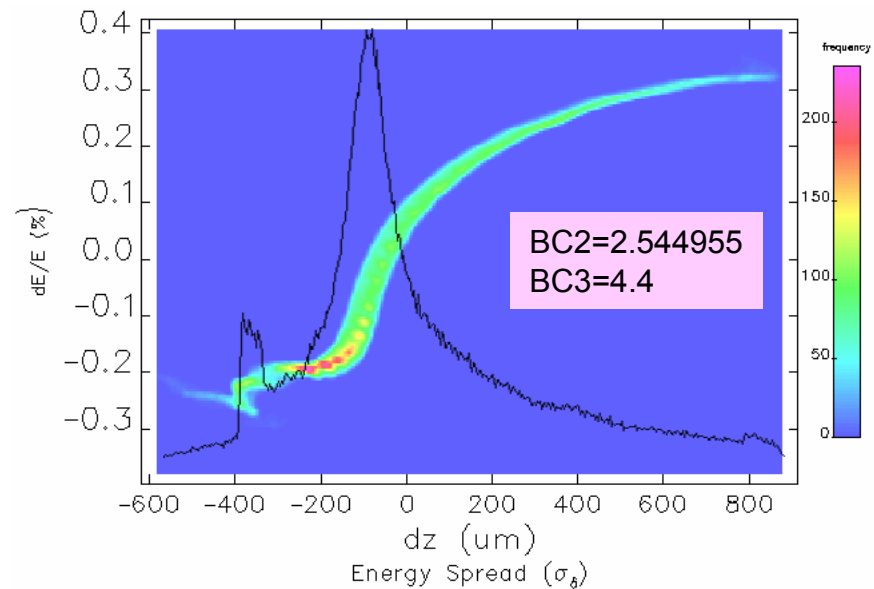
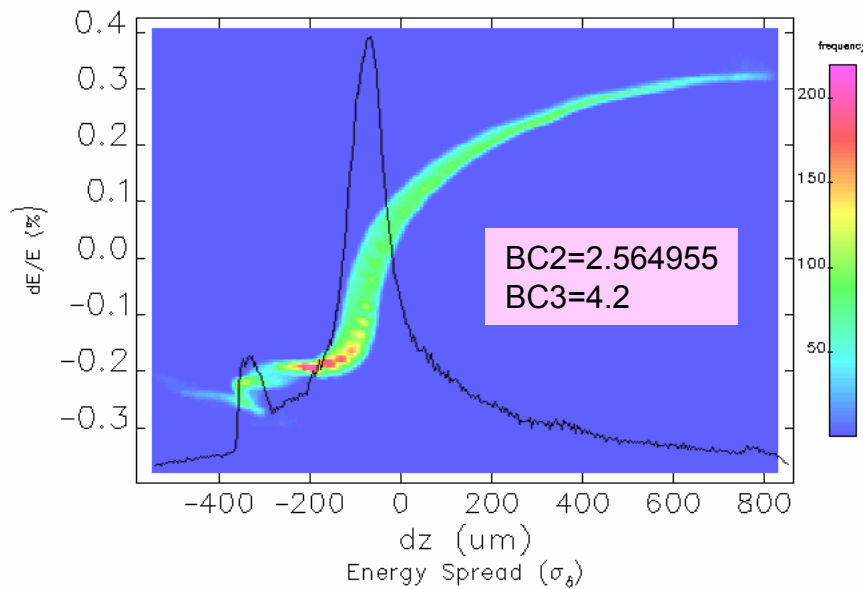
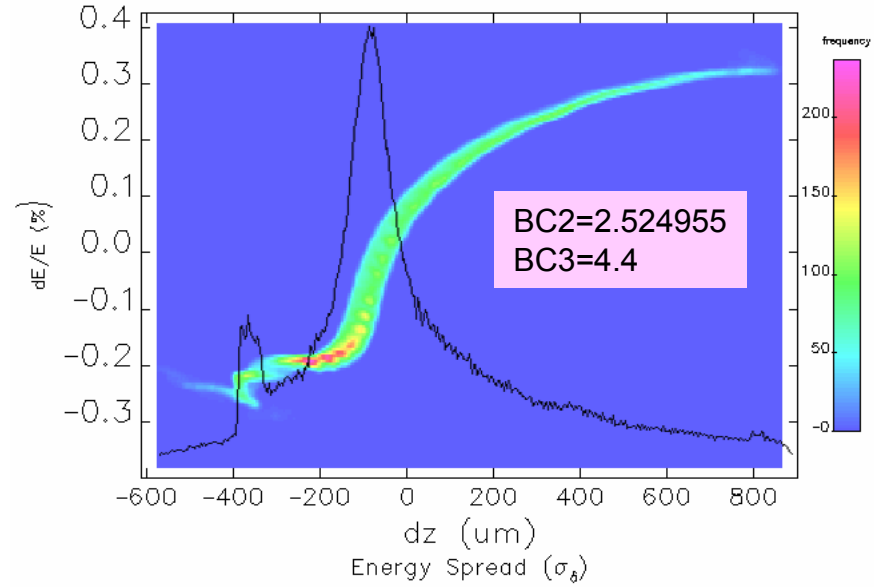
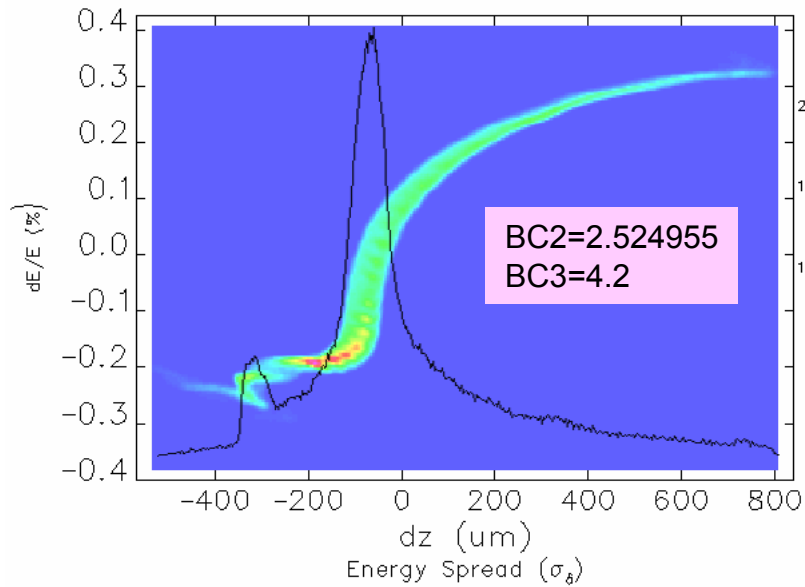
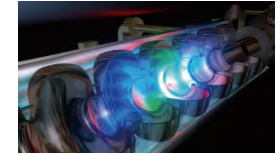

BC3 Scan (type2)

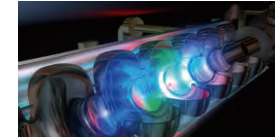

BC2 (m)	BC3 (m)
2.524955	3.60
	3.80
	4.00
	4.20
	4.40
2.544955	3.60
	3.80
	4.00
	4.20
	4.40
2.564955	3.60
	3.80
	4.00
	4.20
	4.40
2.584955	3.60
	3.80
	4.00
	4.20
	4.40
2.604955	3.60
	3.80
	4.00
	4.20
	4.40

FEL Beam I

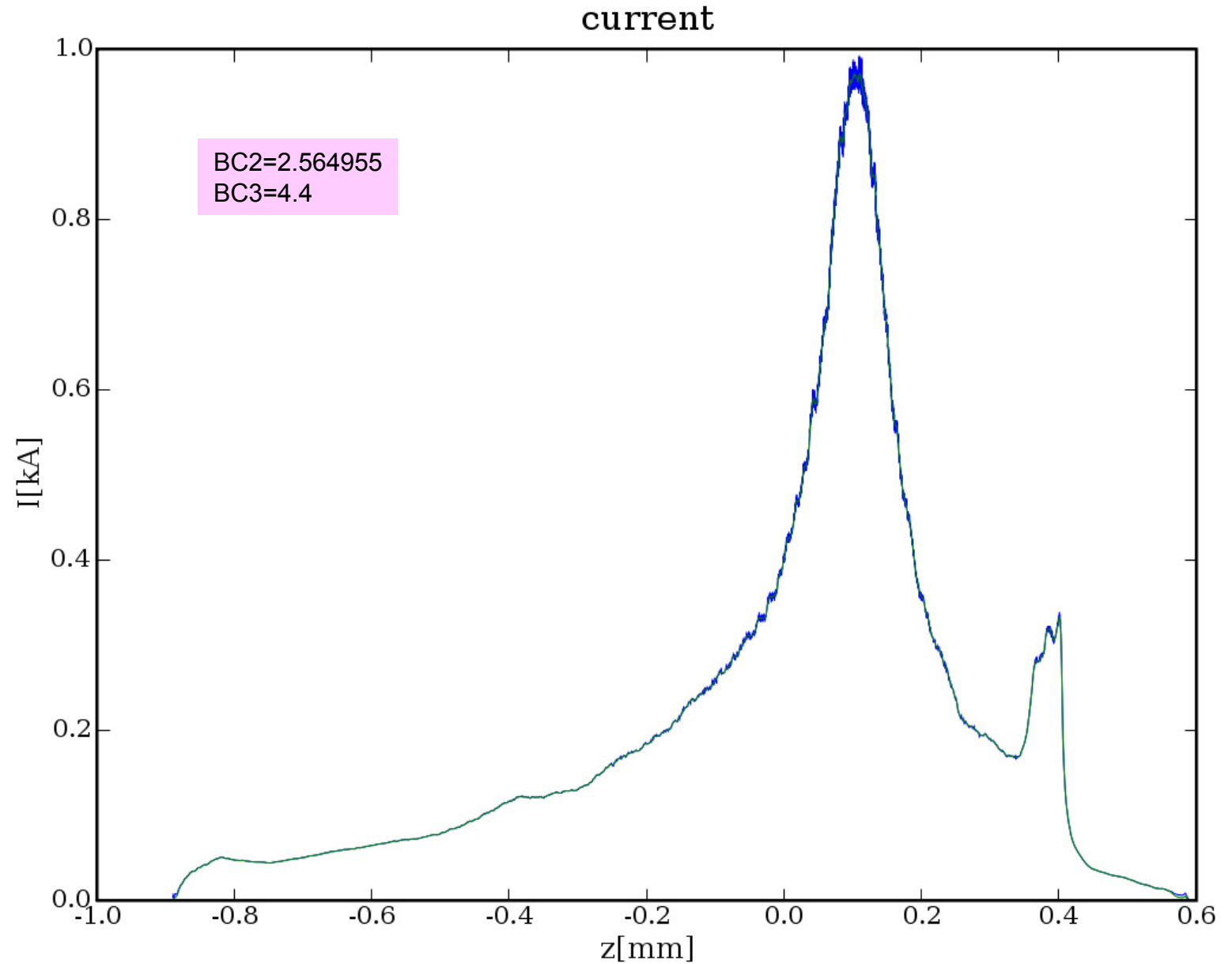

BC3 Scan (type2)

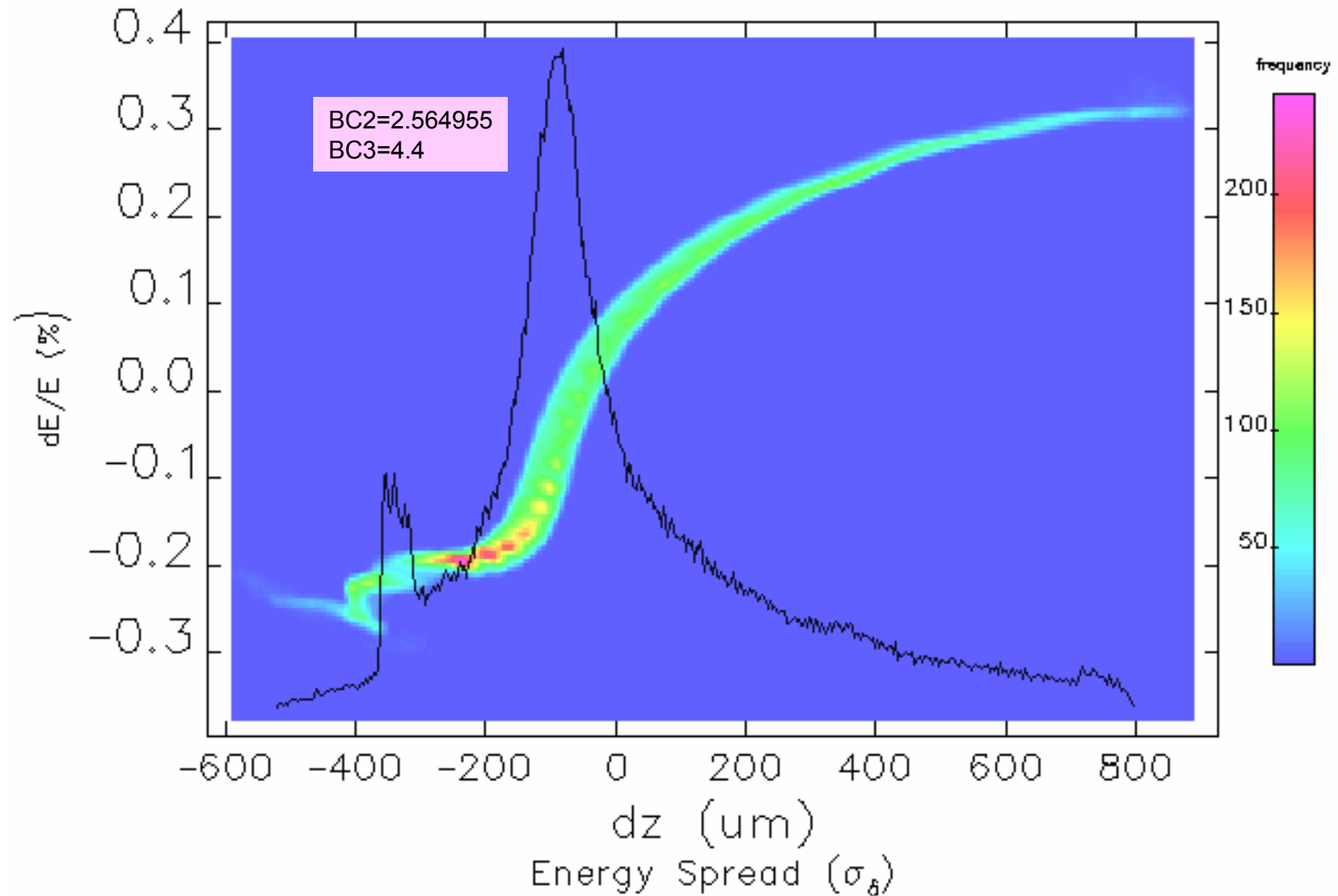
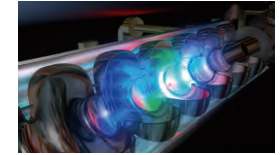

BC3 Scan (type3)

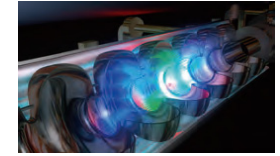

BC2 (m)	BC3 (m)
2.524955	3.60
	3.80
	4.00
	4.20
	4.40
2.544955	3.60
	3.80
	4.00
	4.20
	4.40
2.564955	3.60
	3.80
	4.00
	4.20
	4.40
2.584955	3.60
	3.80
	4.20
	4.40
2.604955	3.60
	3.80
	4.00
	4.40

Needs more exact numerical analysis!

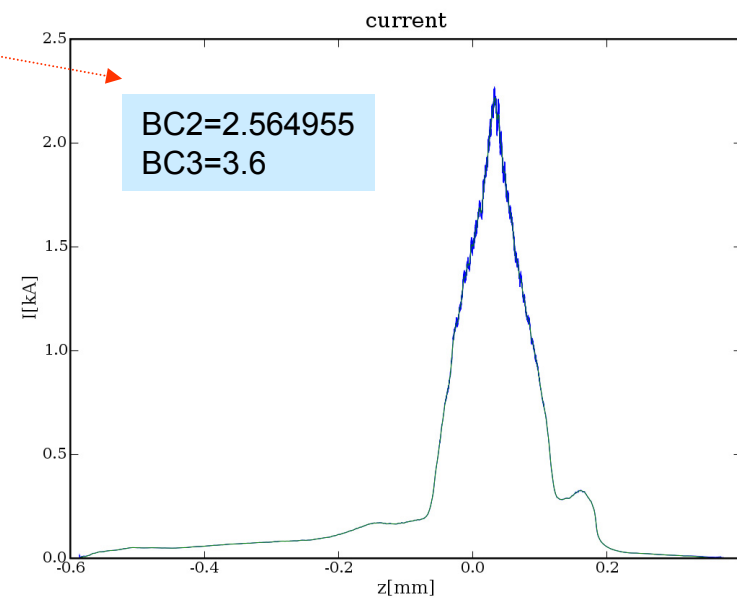
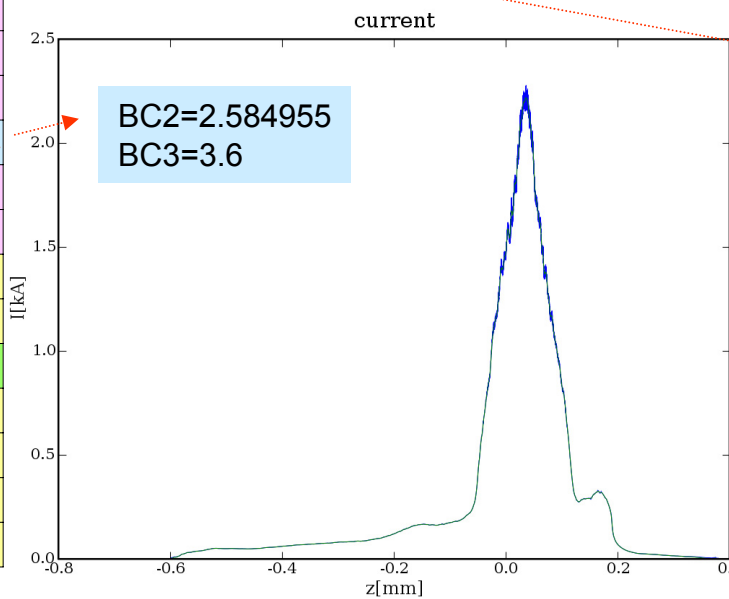
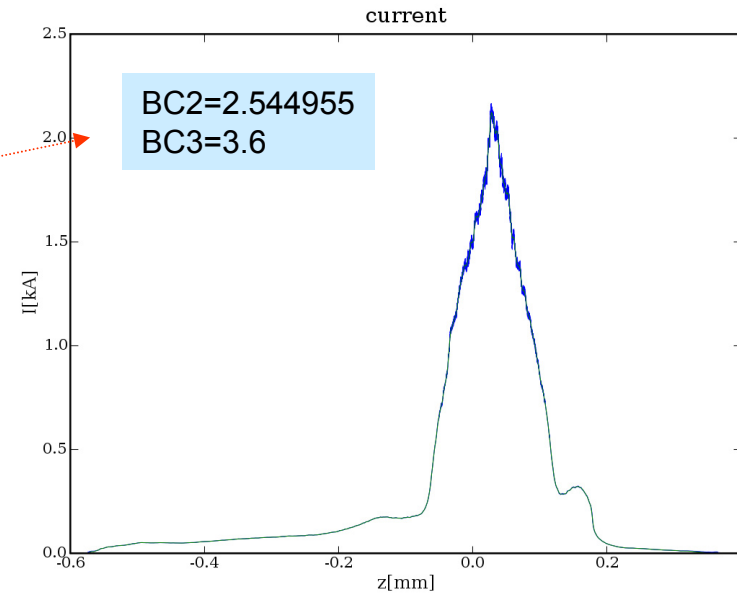

BC3 Scan (type4)

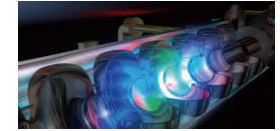

BC2 (m)	BC3 (m)
2.524955	3.60
	3.80
	4.00
	4.20
	4.40
2.544955	3.60
	3.80
	4.00
	4.20
	4.40
2.564955	3.60
	3.80
	4.00
	4.20
	4.40
2.584955	3.60
	3.80
	4.00
	4.20
	4.40
2.604955	3.60
	3.80
	4.00
	4.20
	4.40

FEL Beam Dyr

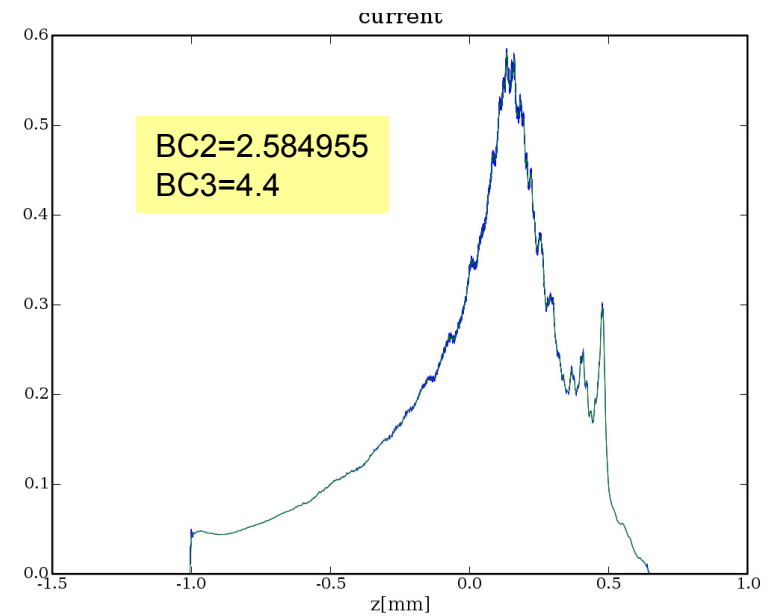
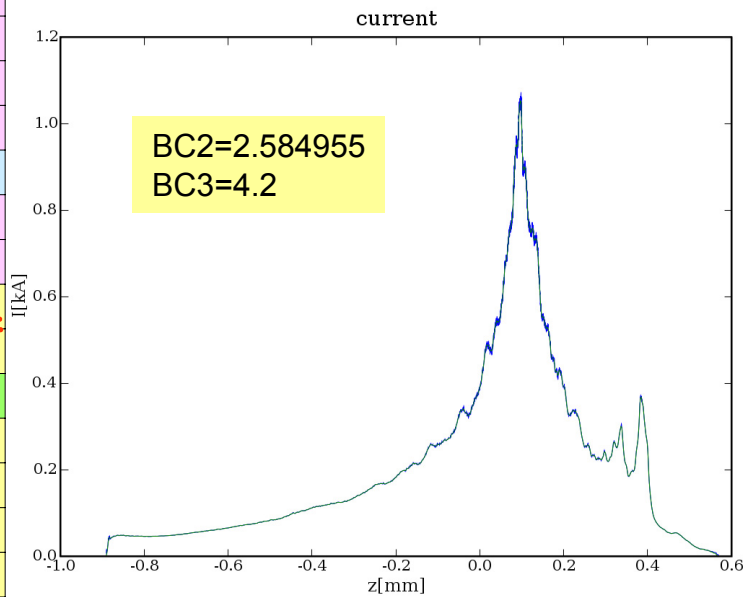
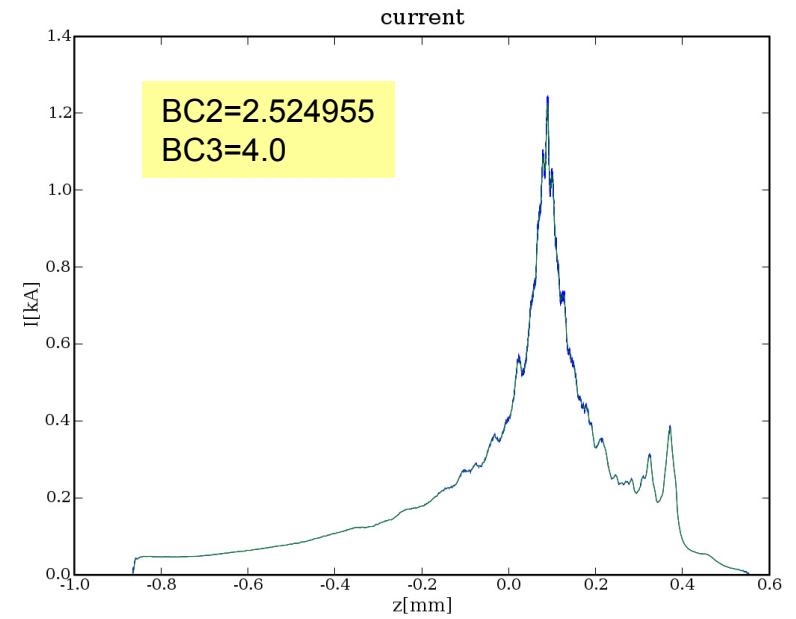
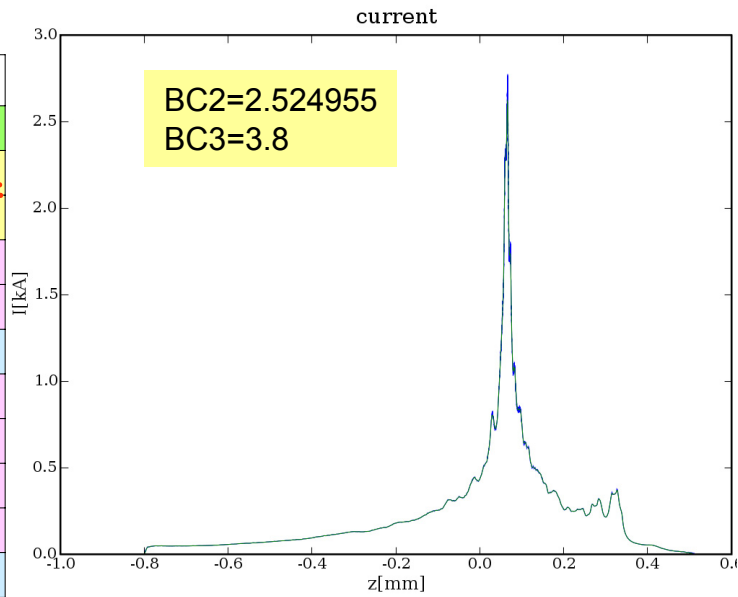

BC3 Scan (type4)

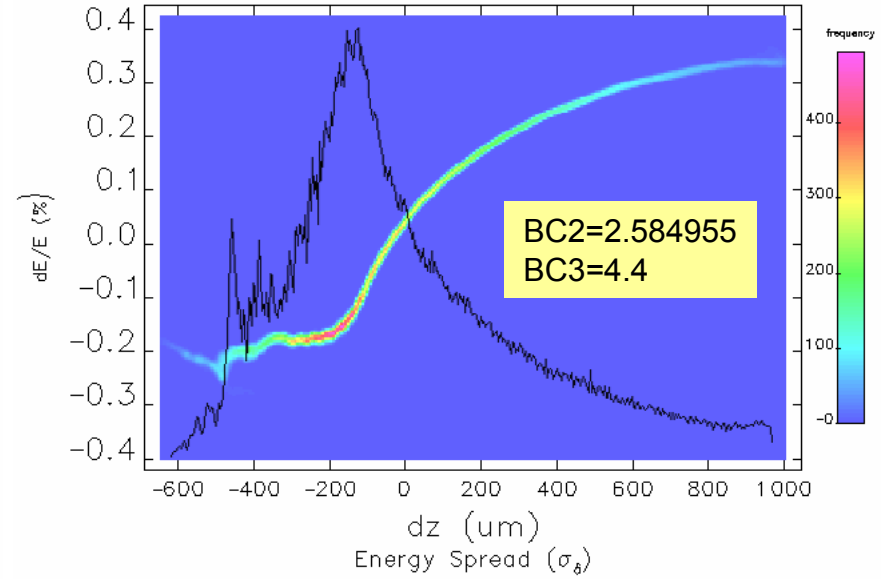
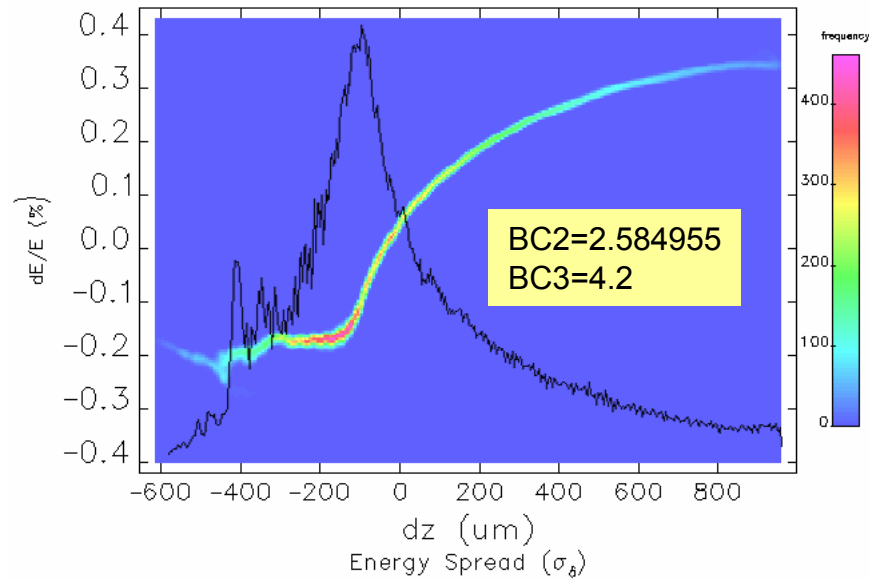
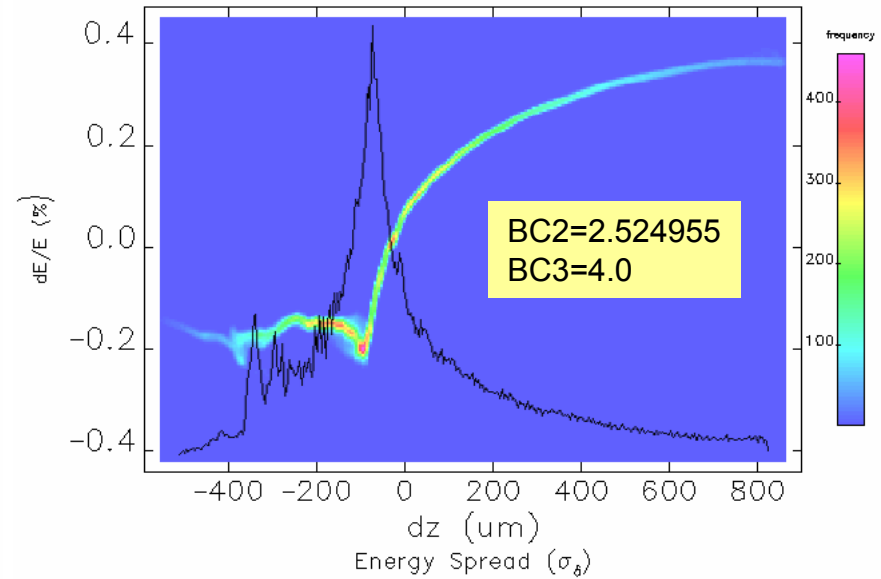
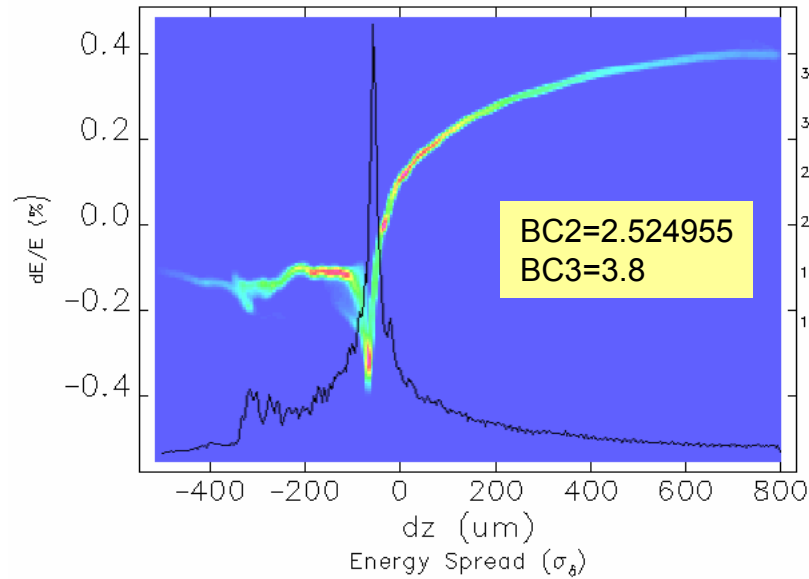
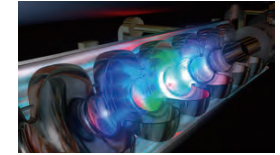

BC3 Scan (type4)

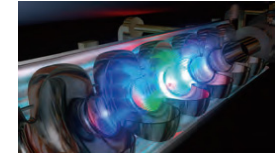

BC2 (m)	BC3 (m)
2.524955	3.60
	3.80
	4.00
	4.20
	4.40
2.544955	3.60
	3.80
	4.00
	4.20
	4.40
2.564955	3.60
	3.80
	4.00
	4.20
	4.40
2.584955	3.60
	3.80
	4.00
	4.20
	4.40
2.604955	3.60
	3.80
	4.00
	4.20
	4.40

FEL Beam Dynamic

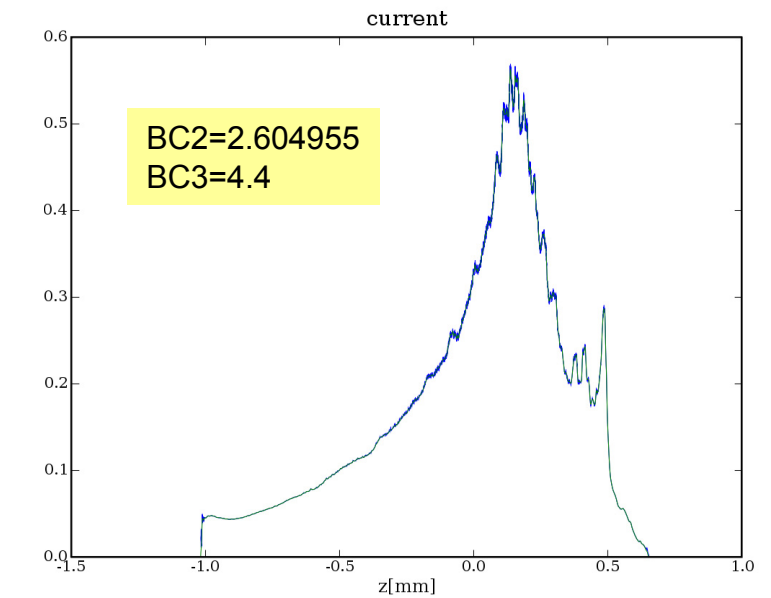
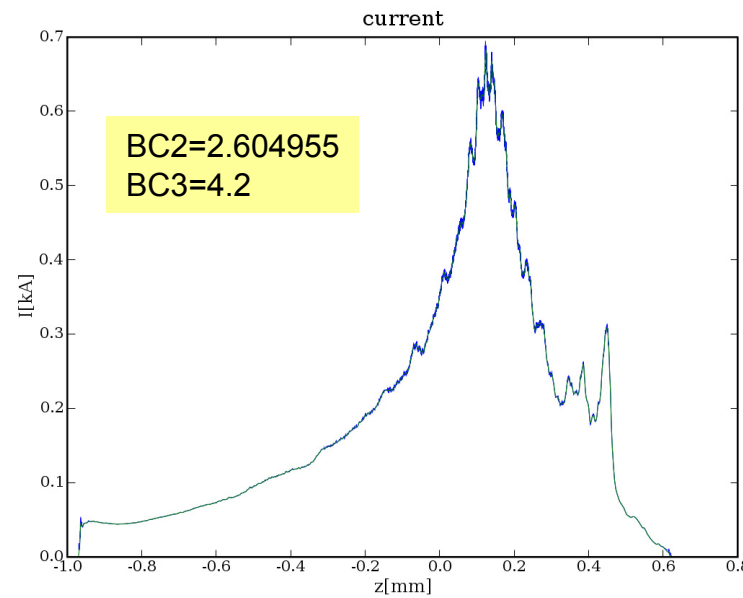
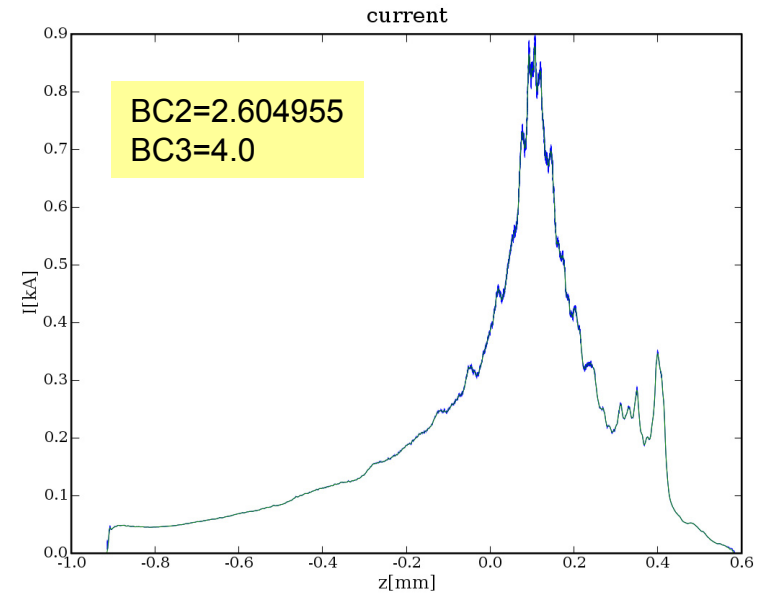
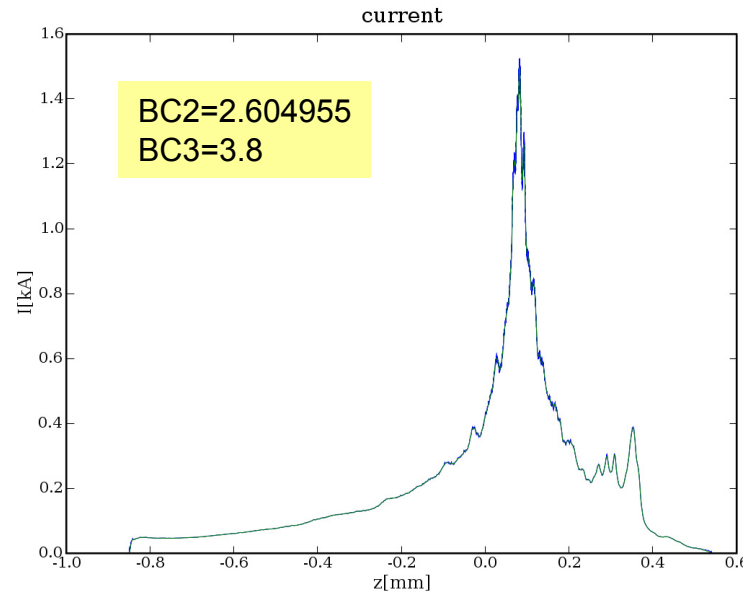

BC3 Scan (type4)

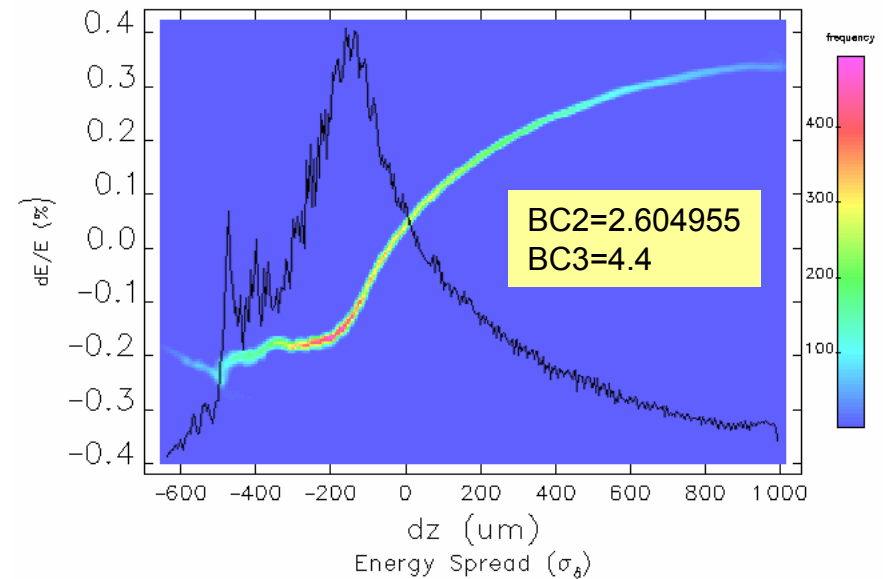
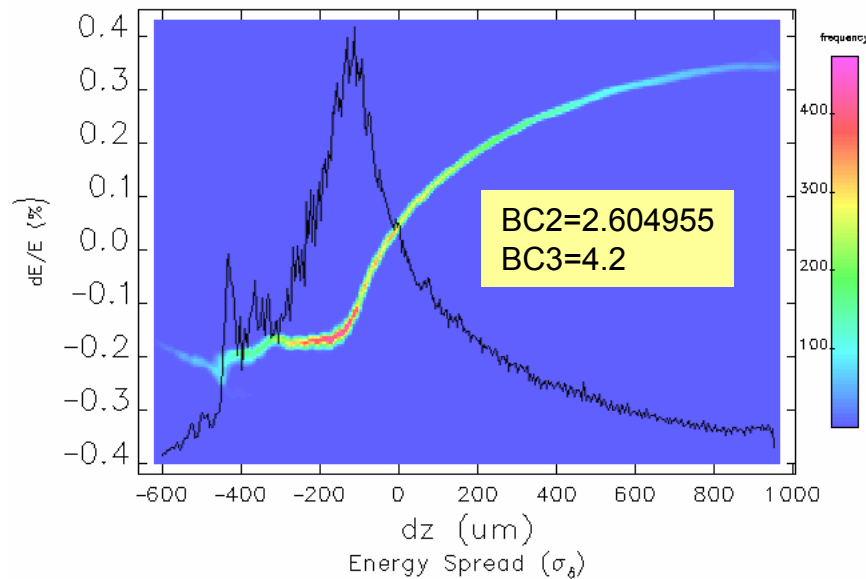
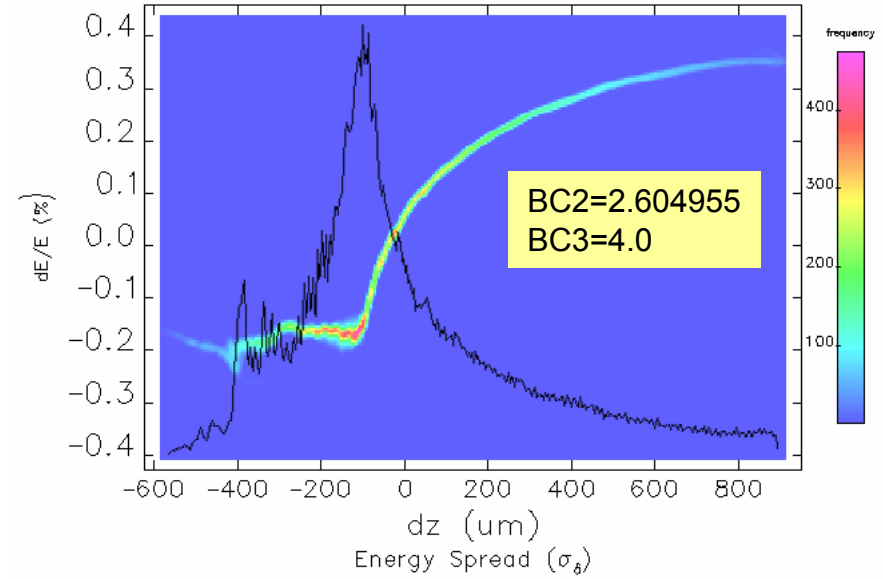
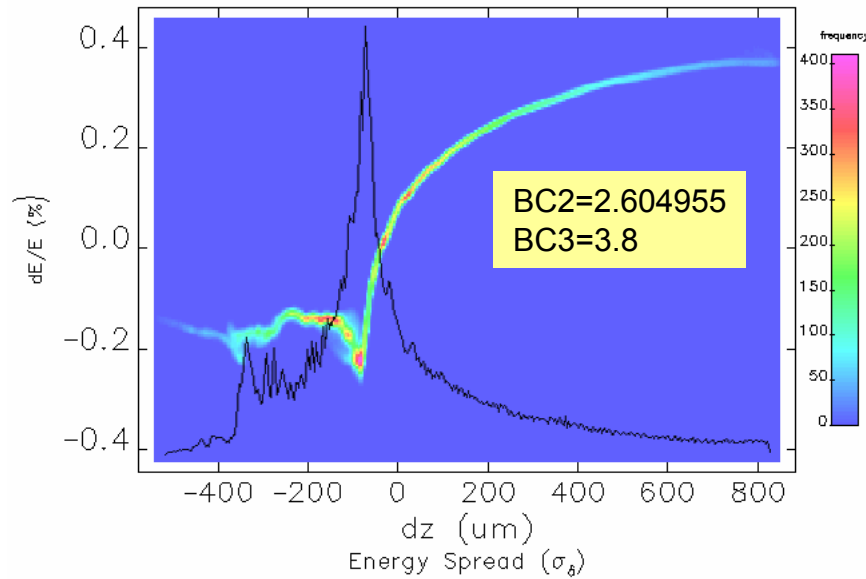
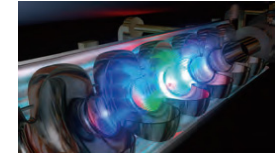

Conclusion

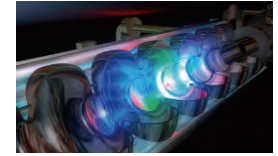

- Next Step
 - Increase the particle number order of million to check the microbunching instability from the numerical error
 - Gain calculation
- In acknowledgment for guidance of Torsten Limberg, Igor Zagorodnov and all the other people of the MPY.