

# absorption of very high frequent EM-fields in cryo-modules

## 1. physical models

single bunch losses, resonant losses

models based on field calculation

0<sup>th</sup> order model: based on energy distribution

1<sup>st</sup> order models: wave propagation

## 2. surface absorption

HOM absorber

surface impedance of cu; ASE

steel

super conducting surface

## 3. module models

XFEL ( = periodic model)

FLASH ( = absorber before open boundary)

## 4. cryo loss results

XFEL ( = periodic model)

FLASH ( = absorber before open





1



2



3

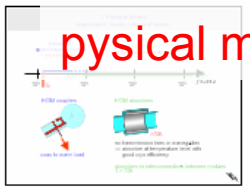

4

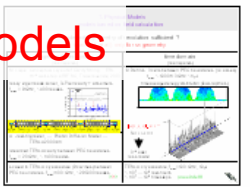

5

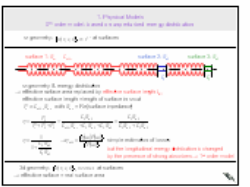

6

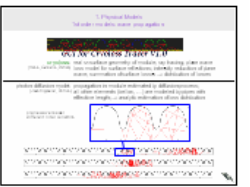

7

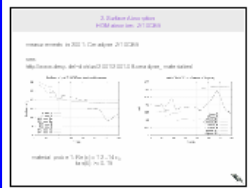

8

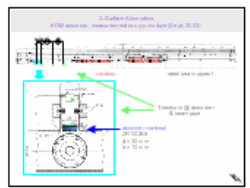

9

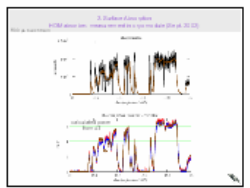

10

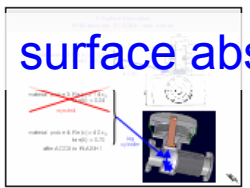

11

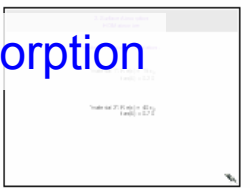

12

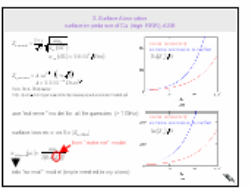

13

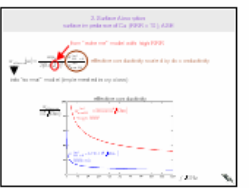

14

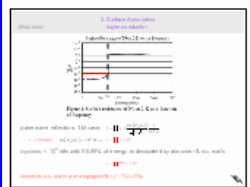

15



16

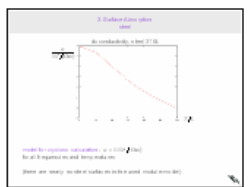

17

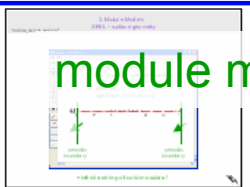

18

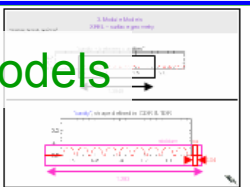

19

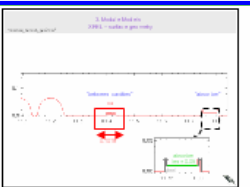

20

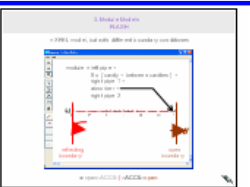

21

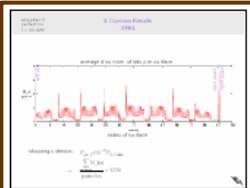

22

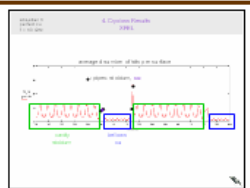

23

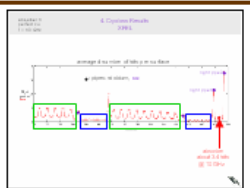

24

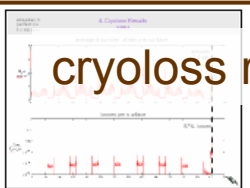

25



26

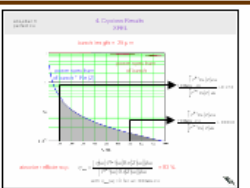

27

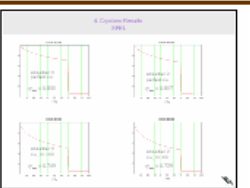

28



29

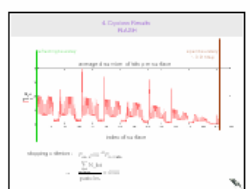

30

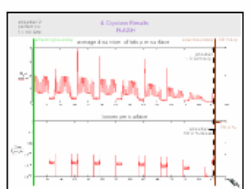

31

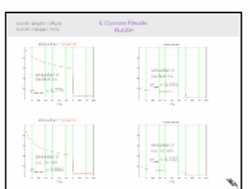

32



33



# 1. Physical Models

## single bunch losses, resonant losses

single bunch losses: asymptotic approximation of longitudinal **short range wake**  $w^{(\delta)}(s)$   
(TESLA module: Novokhatski, Zagorodnov, Weiland; e.g. TESLA 2003-19)

finite bunch length  $\sigma \rightarrow w^{(\sigma)}(s) = \lambda^{(\sigma)}(s) \otimes w^{(\delta)}(s)$

**total loss parameter**  $k_{\text{tot}}^{(\sigma)} = -\frac{1}{c} \int w^{(\sigma)}(s) \lambda^{(\sigma)}(s) ds$

$$P_{\text{single bunch}} = \frac{q^2 k_{\text{tot}}^{(\sigma)}}{T_b}$$

$q$  = bunch charge  
 $T_b$  = time of bunch distance

assumption: field decay time  $\gg T_b$

e.g.  $k_{\text{tot}} \approx 1.53 \cdot 10^{14}$  V/C,  $q = 1$  nC,  $\sigma = 25$   $\mu$ m, 10x3000 bunches/sec  $\rightarrow$  **4.6 W**  
30x3000 bunches/sec  $\rightarrow$  **13.8 W**

resonant losses: eigenmode solver  $\rightarrow$  modes  $\nu$  with qualities  $Q_\nu$ , frequencies  $\omega_\nu$   
and modal loss parameters  $k_\nu$

$$\overline{P}_{\nu, \text{res}} \approx I_b^2 \frac{4Q_\nu k_\nu}{\omega_\nu}$$

assumptions: resonance ( $\omega_\nu T_b = n2\pi$ )  
low decay from bunch to bunch ( $Q_\nu \gg \omega_\nu T_b$ )  
high quality ( $Q_\nu \gg 1$ )  
long rf pulse ( $T_{\text{rf}} \gg 2Q_\nu / \omega_\nu$ )

required: list of modes, qualities, frequencies and modal loss parameters  
( $\rightarrow$  J. Sekutowicz for TESLA cavity)



# 1. Physical Models

single bunch losses, resonant losses

trapped &  
quasi trapped modes:  
~ resonant effects

propagating modes  
~ single bunch effects

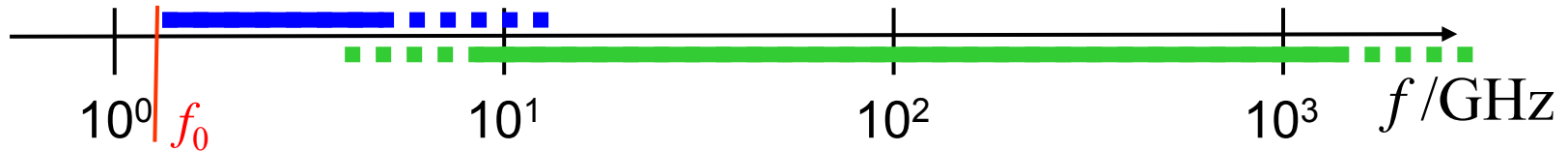

HOM couplers

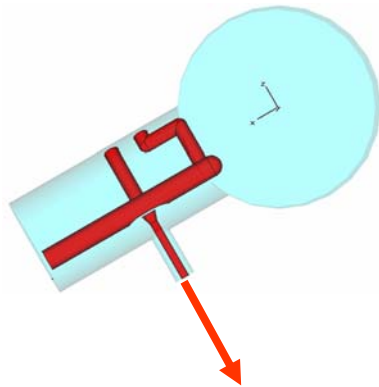

coax to warm load

HOM absorbers

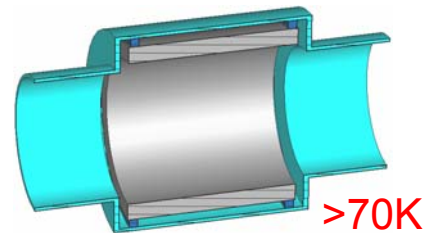

no transmission lines or waveguides  
⇒ absorber at temperature level with  
good cryo efficiency

absorbers in interconnections between modules  
 $T > 70K$



# 1. Physical Models models based on field calculation

model with symmetry of revolution sufficient ?  
doable (if at all) only for rz-geometry

## eigenmode analysis (monopoles)

## time domain (monopoles)

M.Liepe: Conceptual Layout of Cavity String ... ERL ...;  
11<sup>th</sup> workshop of RF SC, Trarvenne, 2003

M.Dohlus: 3 cells between PEC boundaries (no losses)  
 $t_{\max} \sim 1000/1.3\text{GHz} \sim 1\mu\text{s}$

lossy eigenmode solver; 3x7cell-cavity + absorbers:  
 $f_{\max} = 8\text{GHz}; \sim 400$  modes

time averaged energy distribution (few snapshots)

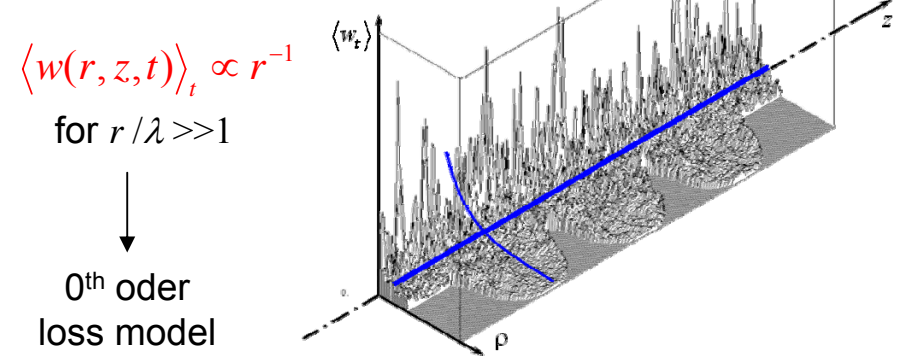
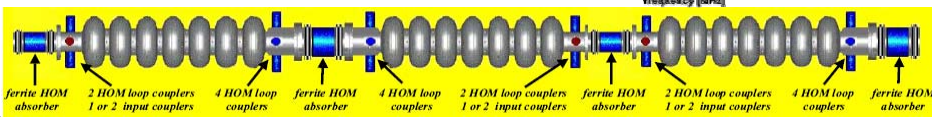
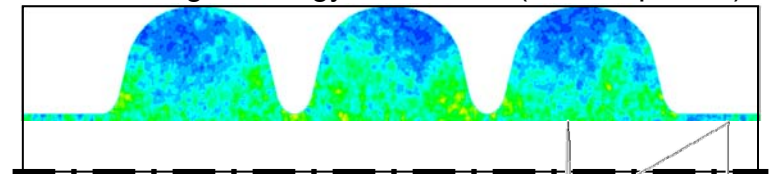
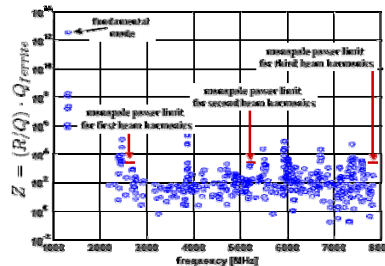

A. Joestingmeier, ...: Photon Diffusion Model ...  
TESLA 2000-11

idealized TESLA cavity between PEC boundaries:  
 $f_{\max} = 20\text{ GHz}; \sim 1400$  modes

scaled to TESLA cryo-module (8 cavities) between  
PEC boundaries:  $f_{\max} = 100\text{ GHz}; \sim 280000$  modes

TESLA cryo-module,  $f_{\max} = 100\text{ GHz}, 10\mu\text{s}$   
 $\sim 10^7 \dots 10^8$  meshcells  
 $\sim 10^7 \dots 10^8$  timesteps **possible !!!**

???



# 1. Physical Models

0<sup>th</sup> order model: based on unperturbed energy distribution

rz geometry:  $\langle w(r, z, t) \rangle_t \propto r^{-1}$  at surfaces

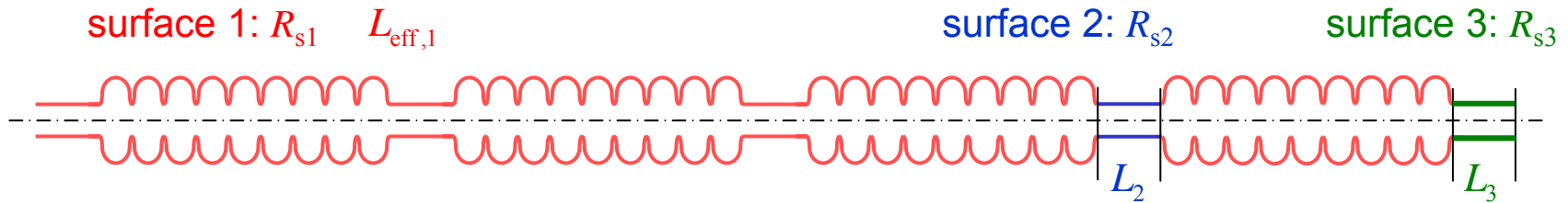

rz-geometry & energy distribution

→ effective surface area replaced by **effective surface length**  $L_{\text{eff}}$   
 effective surface length = length of surface in rz cut

$P_v \propto L_{\text{eff},v} R_{s,v}$  with  $R_{s,v} = \text{Re}\{\text{surface impedance}\}$

$$\eta = \frac{P_3}{P_1 + P_2 + P_3} = \frac{L_3 R_{s,3}}{L_{\text{eff},1} R_{s,1} + L_2 R_{s,2} + L_3 R_{s,3}} \approx \frac{L_3 R_{s,3}}{L_2 R_{s,2} + L_3 R_{s,3}}$$

$$\eta \approx \frac{1}{1 + \frac{L_2 R_{s,2}}{L_3 R_{s,3}}} \rightarrow \eta_{\text{eff}} \approx \frac{\langle \eta(\omega) P(\omega) \rangle}{\langle P(\omega) \rangle}$$

simple estimation of losses

but the longitudinal energy distribution is changed  
 by the presence of strong absorbers → 1<sup>st</sup> order model

3d geometry:  $\langle w(r, z, t) \rangle_t \approx \text{const}$  at surfaces

→ effective surface = real surface area



# 1. Physical Models

## 1st order models: wave propagation

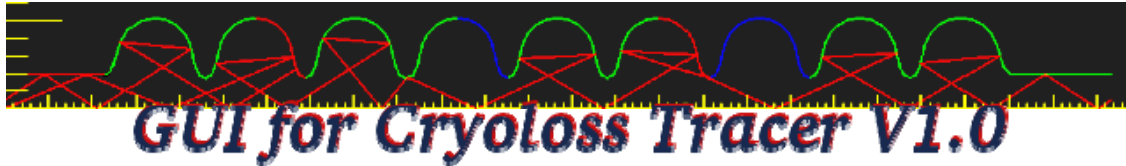

**cryoloss:** real rz-surface geometry of module; ray tracing; plane wave loss model for surface reflections; intensity reduction of plane wave; summation of surface losses → distribution of losses  
(Voss, Clemens, Dohlus)

photon diffusion model: propagation in module estimated by diffusion process;  
(Joestingmeier, Dohlus) all other elements (bellow, ...) are modeled by pipes with effective length; → analytic estimation of loss distribution

plane wave model:  
different initial conditins

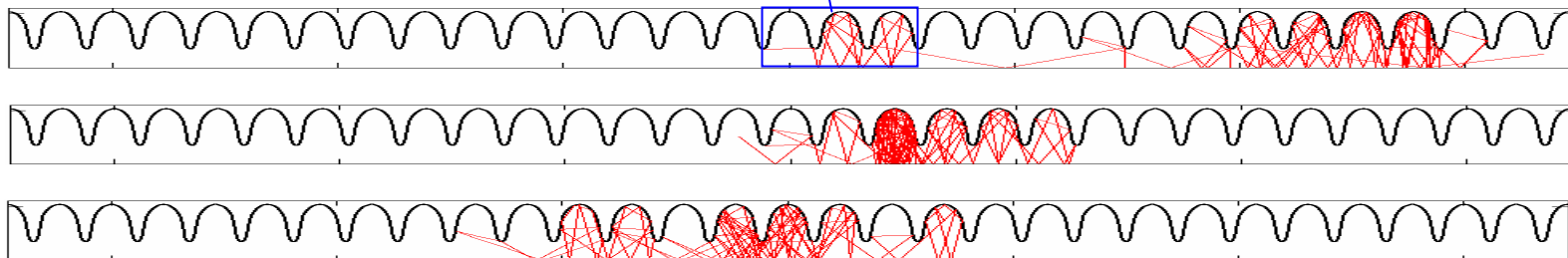
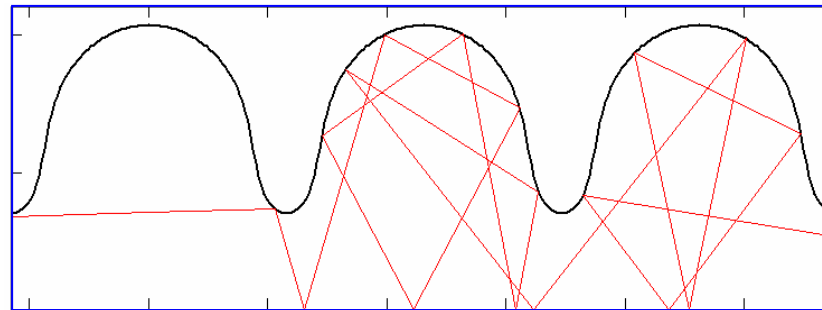

## 2. Surface Absorption HOM absorber: Zr10CB5

measurements in 2001: Ceradyne Zr10CB5

see:

[http://www.desy.de/~dohlus/2001/2001.08.ceradyne\\_materialien/](http://www.desy.de/~dohlus/2001/2001.08.ceradyne_materialien/)

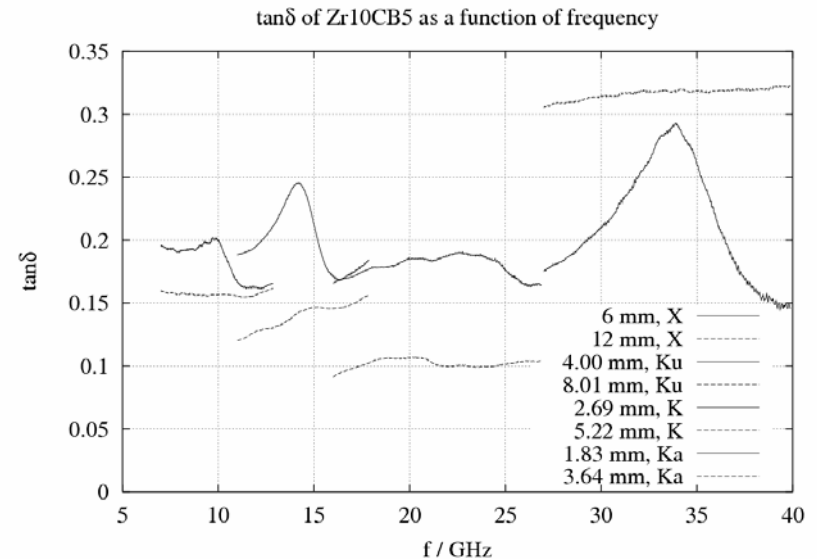
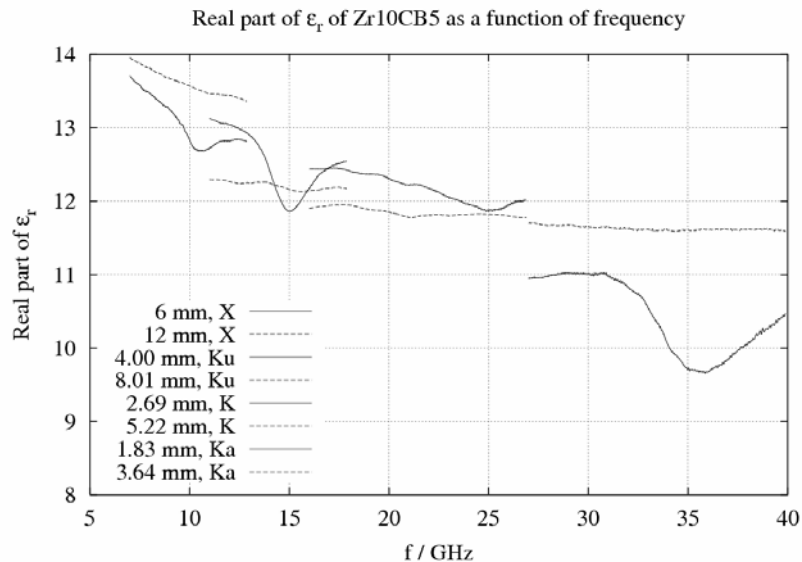

material probe 1:  $\text{Re}(\epsilon) \approx 12 \dots 14 \epsilon_0$   
 $\tan(\delta) > \approx 0.15$





## 2. Surface Absorption

HOM absorber: measurement in cryo module (Sept. 2002)

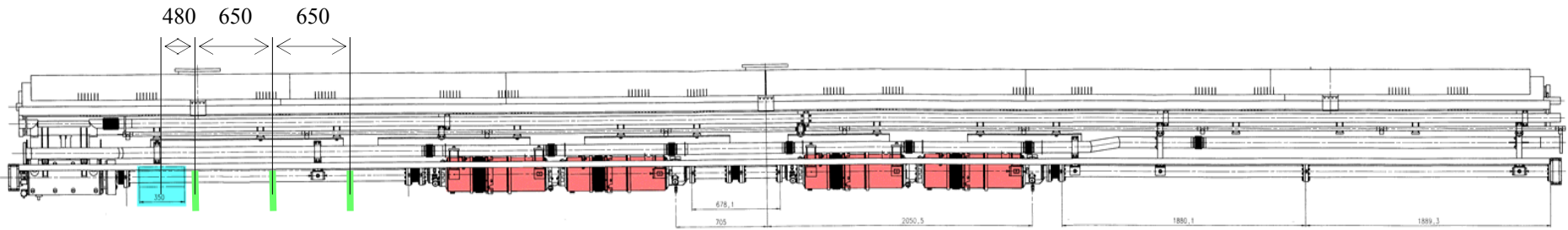

cavities

steel beam pipes !

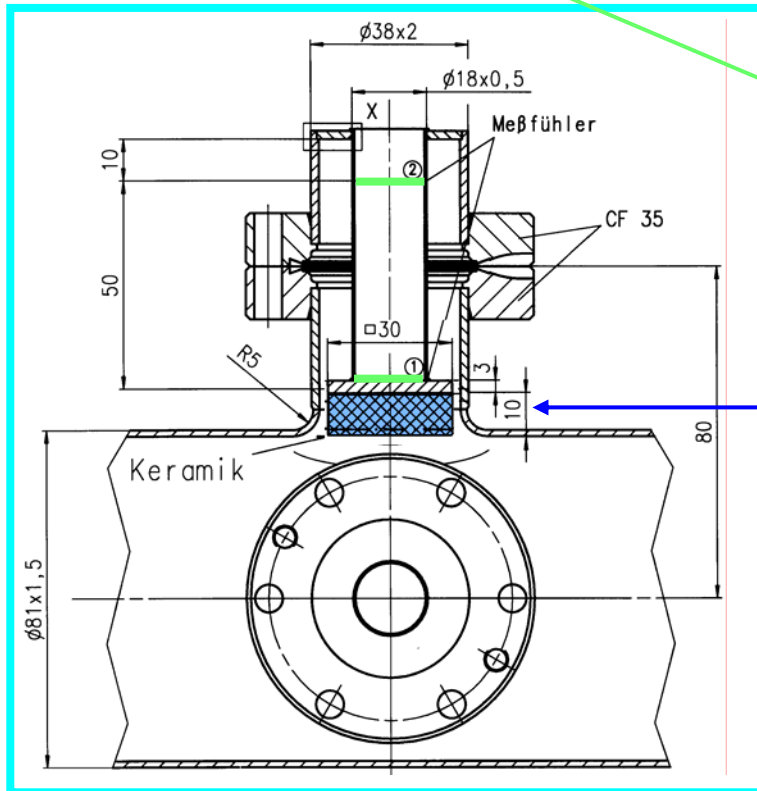

T sensors @ absorber & beam pipe

absorber material

ZR10CB5

d = 30 mm

h = 10 mm



## 2. Surface Absorption

### HOM absorber: measurement in cryo module (Sept. 2002)

500  $\mu$ s bunch train

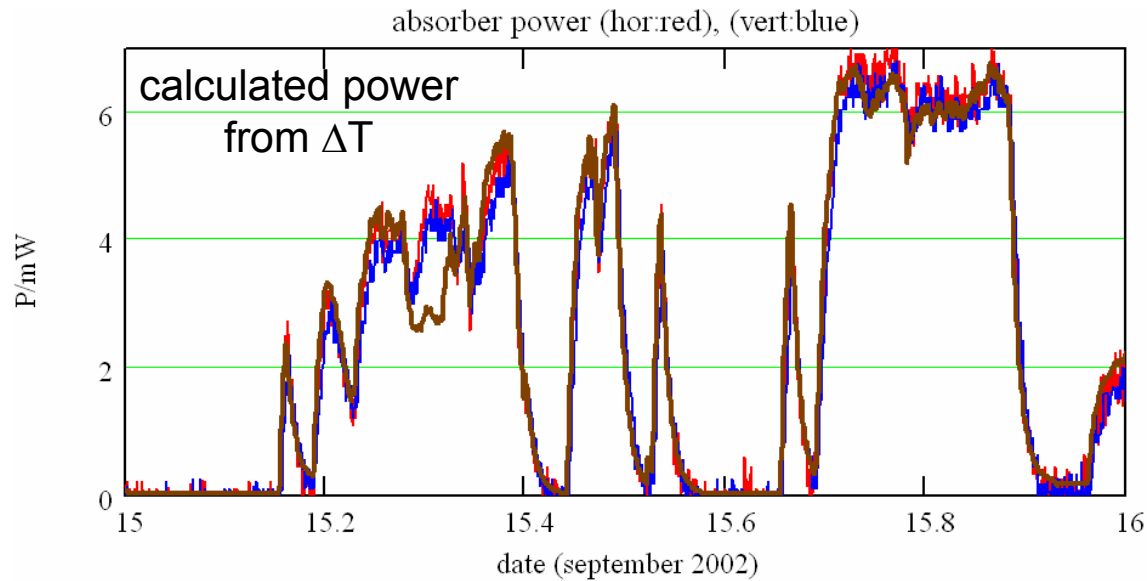
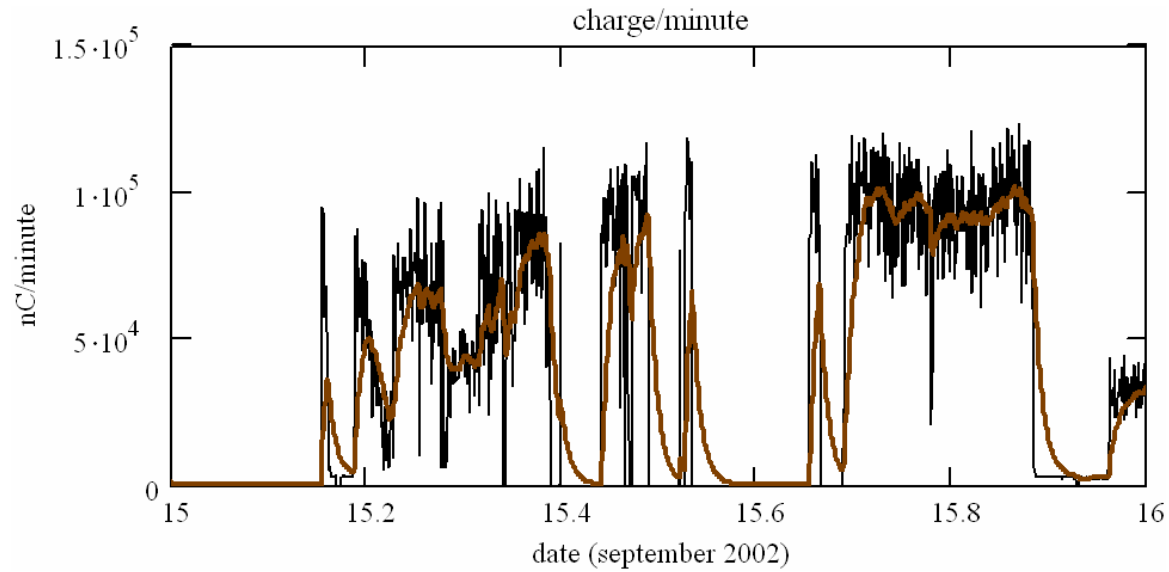

## 2. Surface Absorption HOM absorber: Zr10CB5 – new probes

material probe 2:  $\text{Re}(\epsilon) \approx 16.5 \epsilon_0$   
 $\tan(\delta) \approx 0.20$

small disc  
 $d = 30$

~~material probe 3:  $\text{Re}(\epsilon) \approx 14 \epsilon_0$   
 $\tan(\delta) \approx 0.04$~~

~~rejected~~

material probe 4:  $\text{Re}(\epsilon) \approx 40 \epsilon_0$   
 $\tan(\delta) \approx 0.70$

after ACC6 in FLASH !

big cylinder

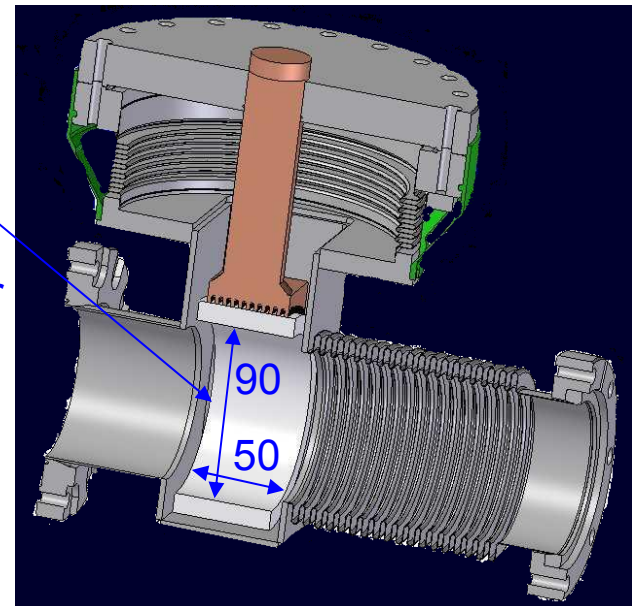
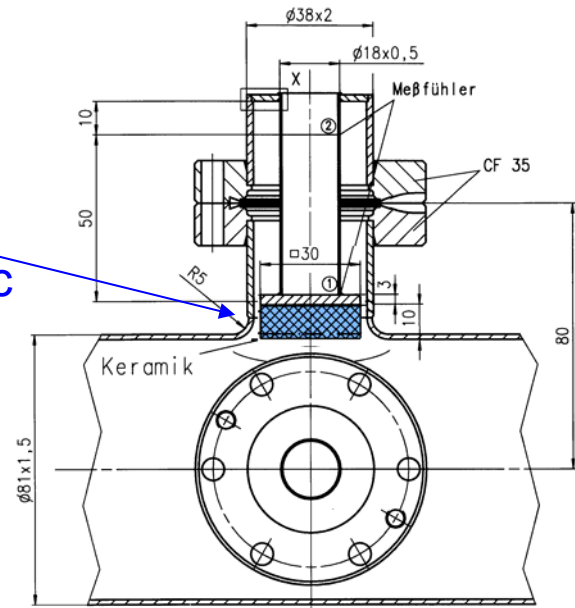

## 2. Surface Absorption HOM absorber

model for cryoloss calculation:

“material 1”:  $\text{Re}(\epsilon) = 15 \epsilon_0$   
 $\tan(\delta) \approx 0.20$

“material 2”:  $\text{Re}(\epsilon) = 40 \epsilon_0$   
 $\tan(\delta) \approx 0.70$



## 2. Surface Absorption surface impedance of Cu (high RRR), ASE

$$Z_{s\_normal} = \frac{1+i}{\sqrt{2}} \sqrt{\frac{\omega\mu_0}{\kappa_{cu}(4K)}}$$

$$\kappa_{cu}(4K) = 3.6 \cdot 10^9 / (\Omega m)$$

$$Z_{s\_extreme} = A \cdot \omega^{2/3} \cdot (1 + i\sqrt{3})$$

$$A = 3.3 \cdot 10^{-10} \Omega \text{sec}^{2/3}$$

from Boris Podobedov:  
<http://pubweb.bnl.gov/users/borisp/www/papers/anomskinrwtalk.pdf>

use “extreme” model for all frequencies (> 1GHz)

surface losses  $\propto$  on  $\text{Re}\{Z_{\text{surface}}\}$

$$\kappa_{\text{effective}}(\omega) = \frac{\omega\mu_0}{2(\text{Re}\{Z_s\})^2}$$

from “extreme” model

↓  
 into “normal” model (implemented in cryoloss)

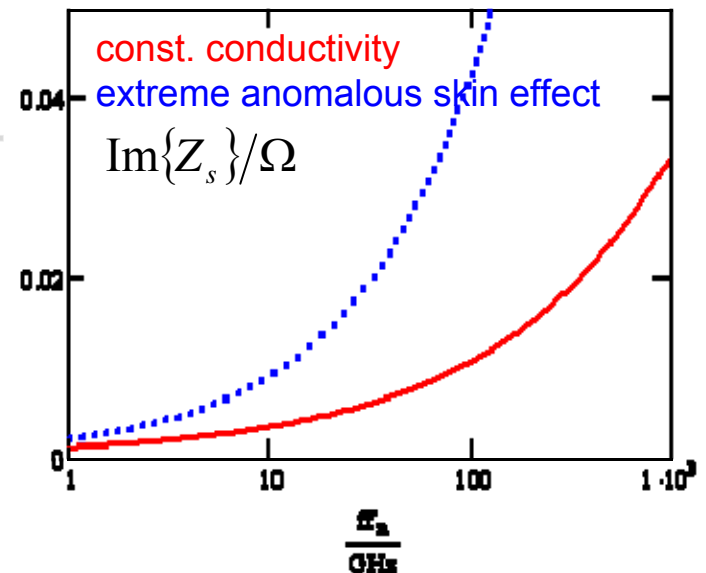
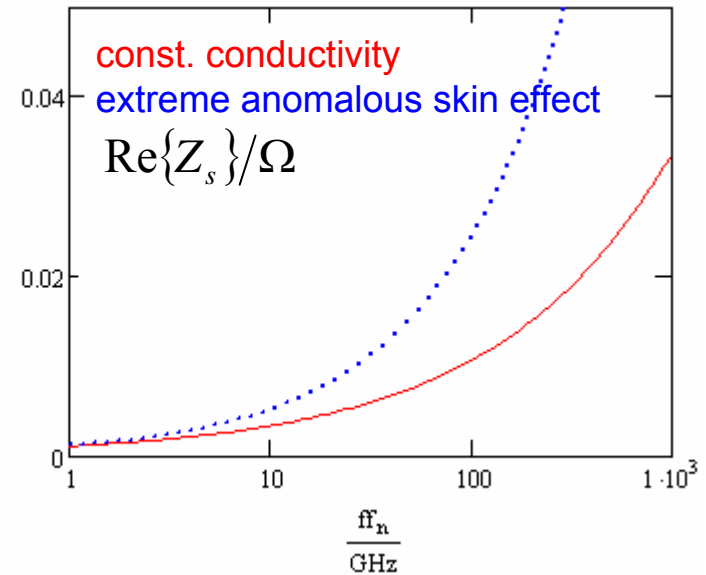

## 2. Surface Absorption

surface impedance of Cu (RRR  $\approx 10$ ), ASE

from “extreme” model with high RRR

$$\kappa_{\text{effective}}(\omega) = \frac{\omega\mu_0}{2(\text{Re}\{Z_s\})^2} \cdot \frac{\kappa_{\text{RRR}=10}^{(\text{dc})}}{\kappa_{\text{high RRR}}^{(\text{dc})}}$$

effective conductivity scaled by dc conductivity

↓  
into “normal” model (implemented in cryoless)

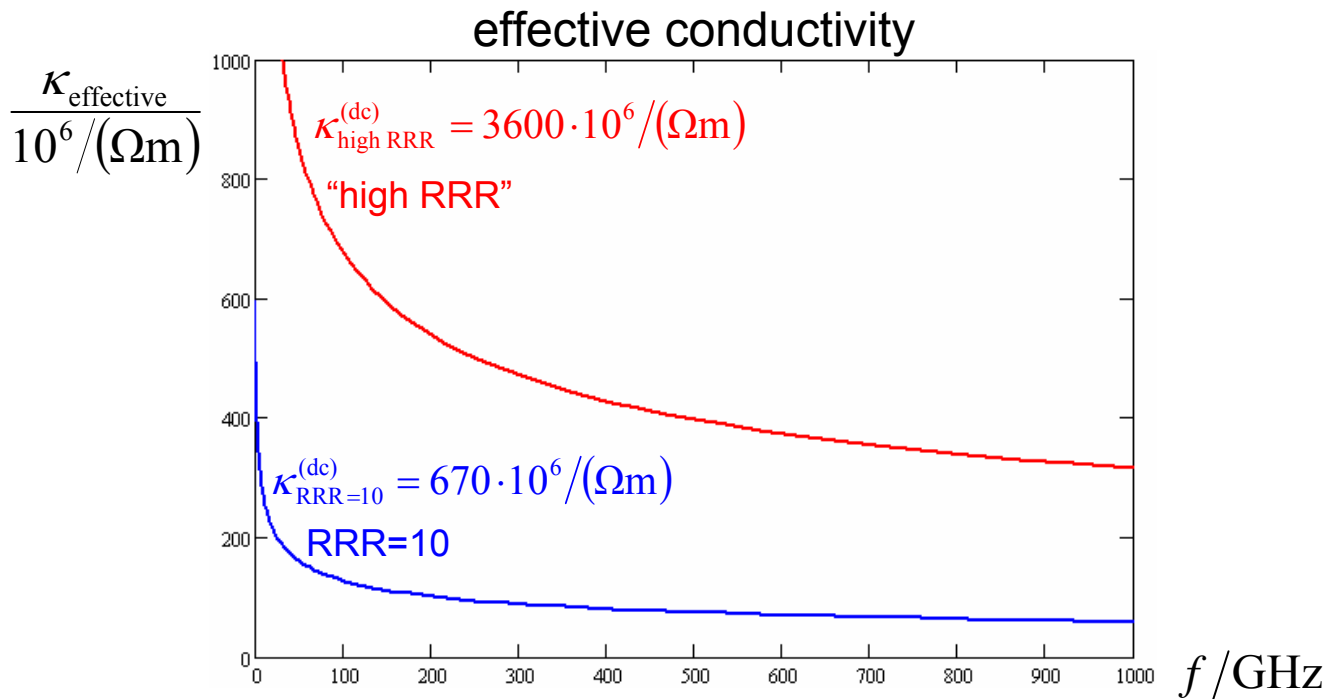

## 2. Surface Absorption super conductor

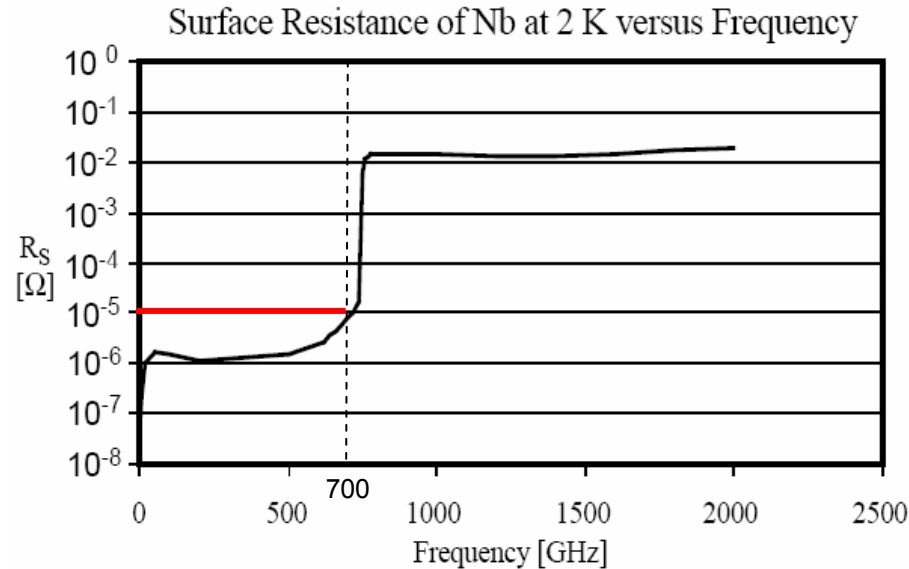

Figure 1: Surface resistance of Nb at 2 K as a function of frequency

plane wave reflection, TM case:  $1 - |r|^2 \approx 4 \frac{\text{Re}\{Z_s(\omega)\}}{\sqrt{\mu_1/\epsilon_1}} \frac{1}{\cos \varphi}$

$$f < 700\text{GHz} : \text{Re}\{Z_s(\omega)\} < 10^{-5} \Omega \rightarrow 1 - |r|^2 \approx 10^{-7}$$

cryoloss:  $< 10^4$  hits until 99.99% of energy is dissipated by absorber & n.c. walls

$$1 - |r|^{20000} \approx 10^{-3}$$

losses to s.c. walls are negligible for  $f < 700$  GHz



## 2. Surface Absorption super conductor

model for cryo loss calculation

$$\kappa(\omega) = \begin{cases} \infty & \text{if } f < 700 \text{ GHz} \\ 10^6 / (\Omega m) & \text{otherwise} \end{cases}$$





## 2. Surface Absorption steel

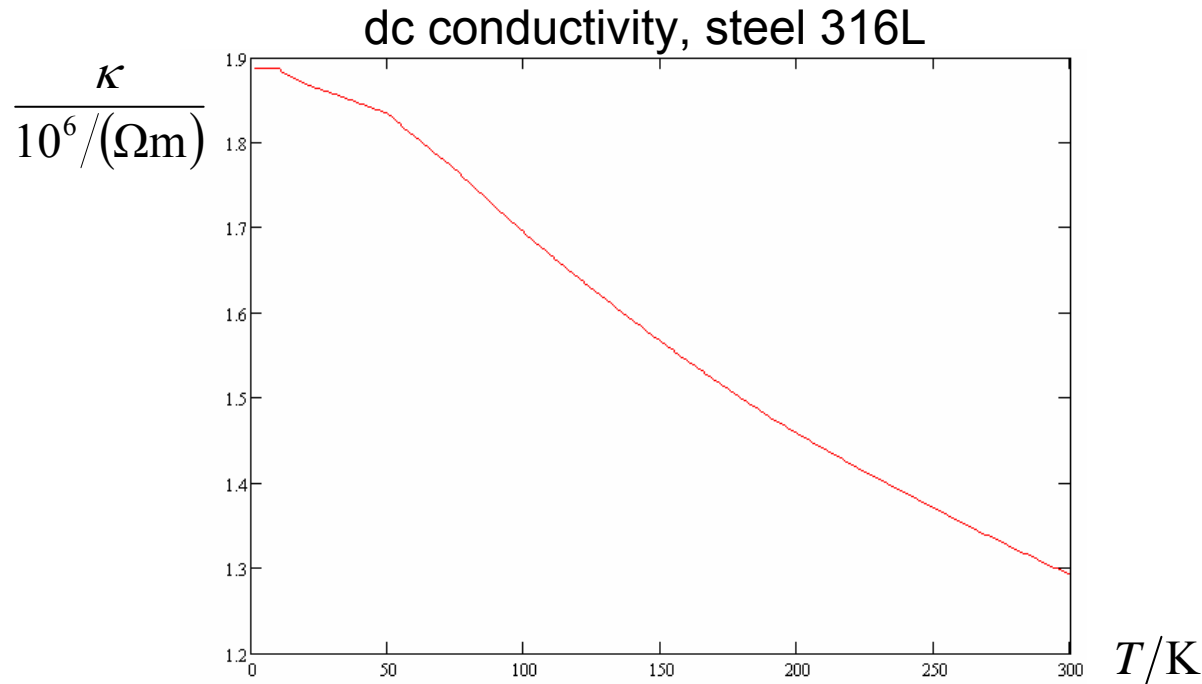

model for cryoloss calculation:  $\kappa = 1 \cdot 10^6 / (\Omega\text{m})$   
for all frequencies and temperatures

(there are nearly no steel surfaces in the used module-model)



### 3. Module Models XFEL – surface geometry

“module\_bellows\_geo2.cav”

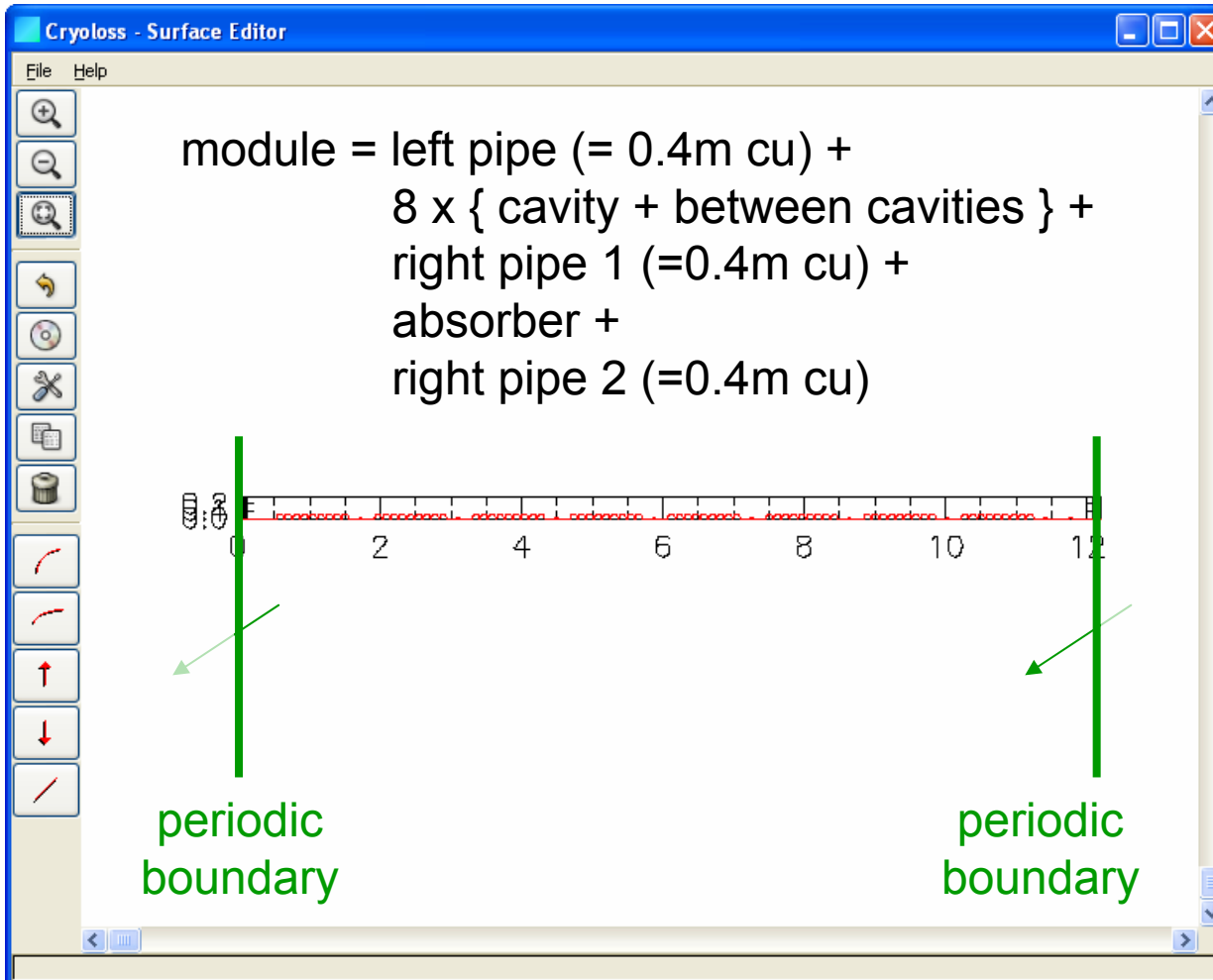

**= infinite string of cold modules !**



### 3. Module Models XFEL – surface geometry

“module\_bellows\_geo2.cav”

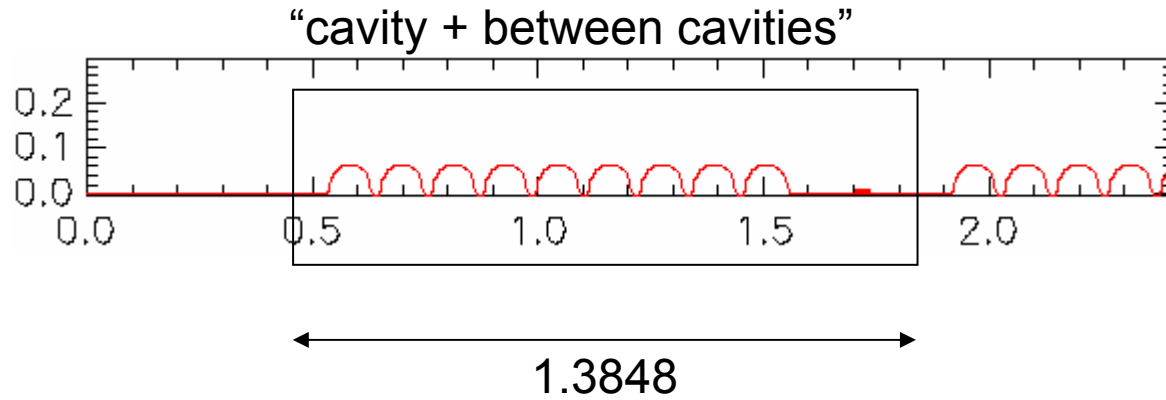

“cavity”, shape defined in CDR & TDR

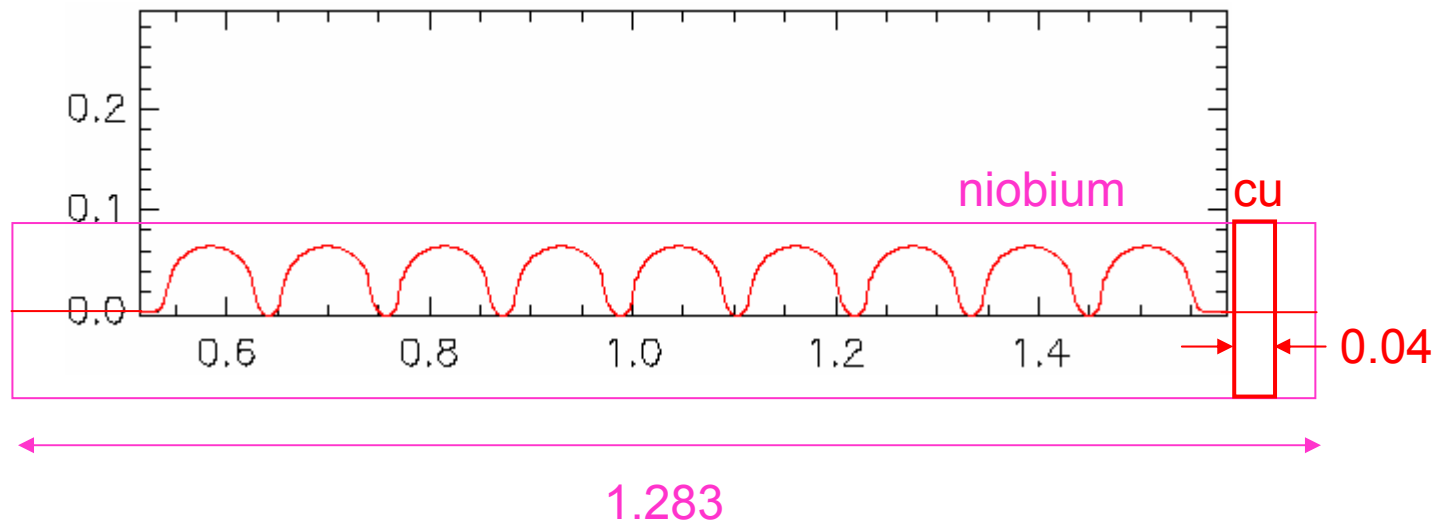

### 3. Module Models XFEL – surface geometry

“module\_bellows\_geo2.cav”

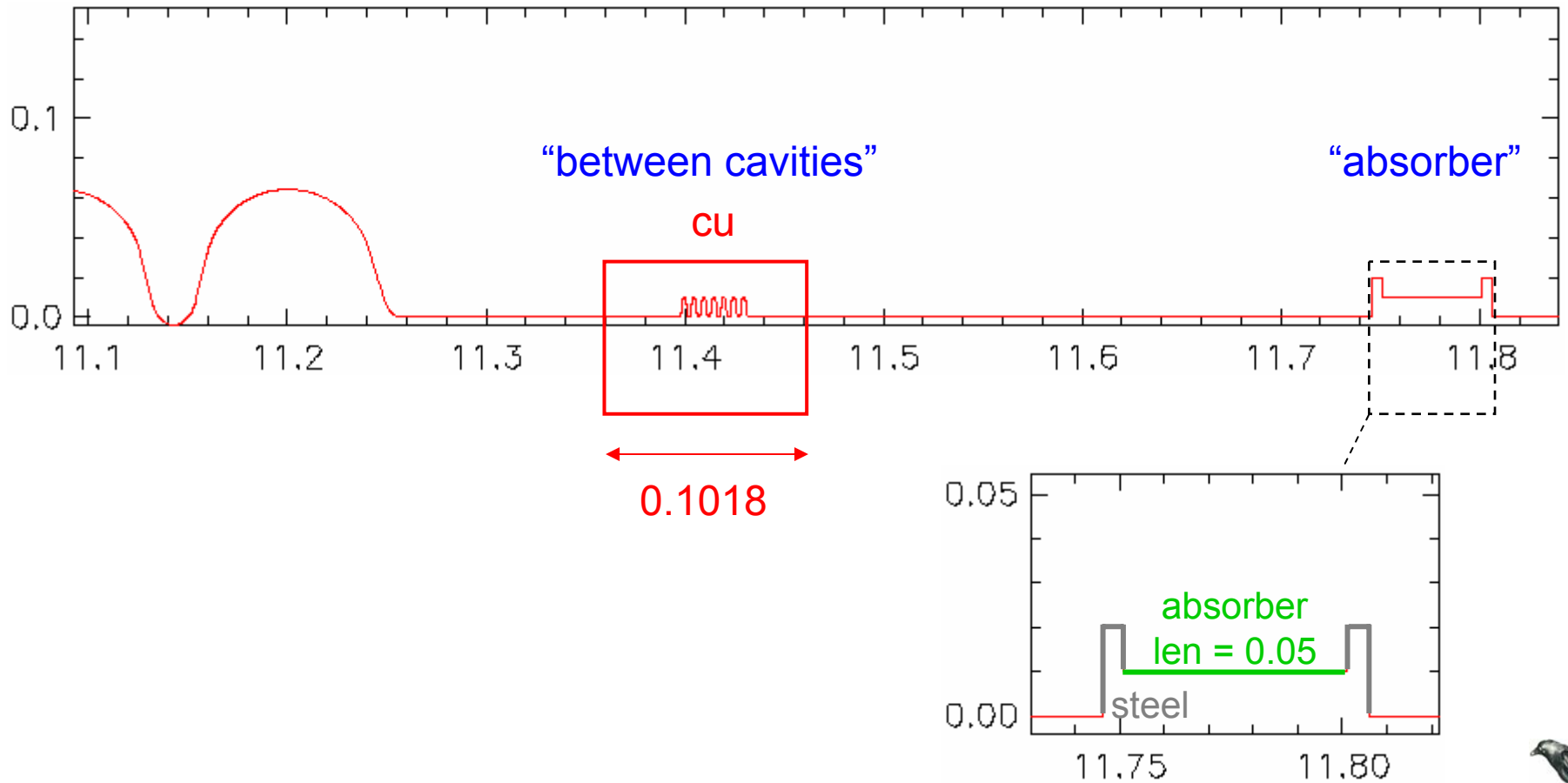

### 3. Module Models FLASH

= XFEL model, but with different boundary conditions

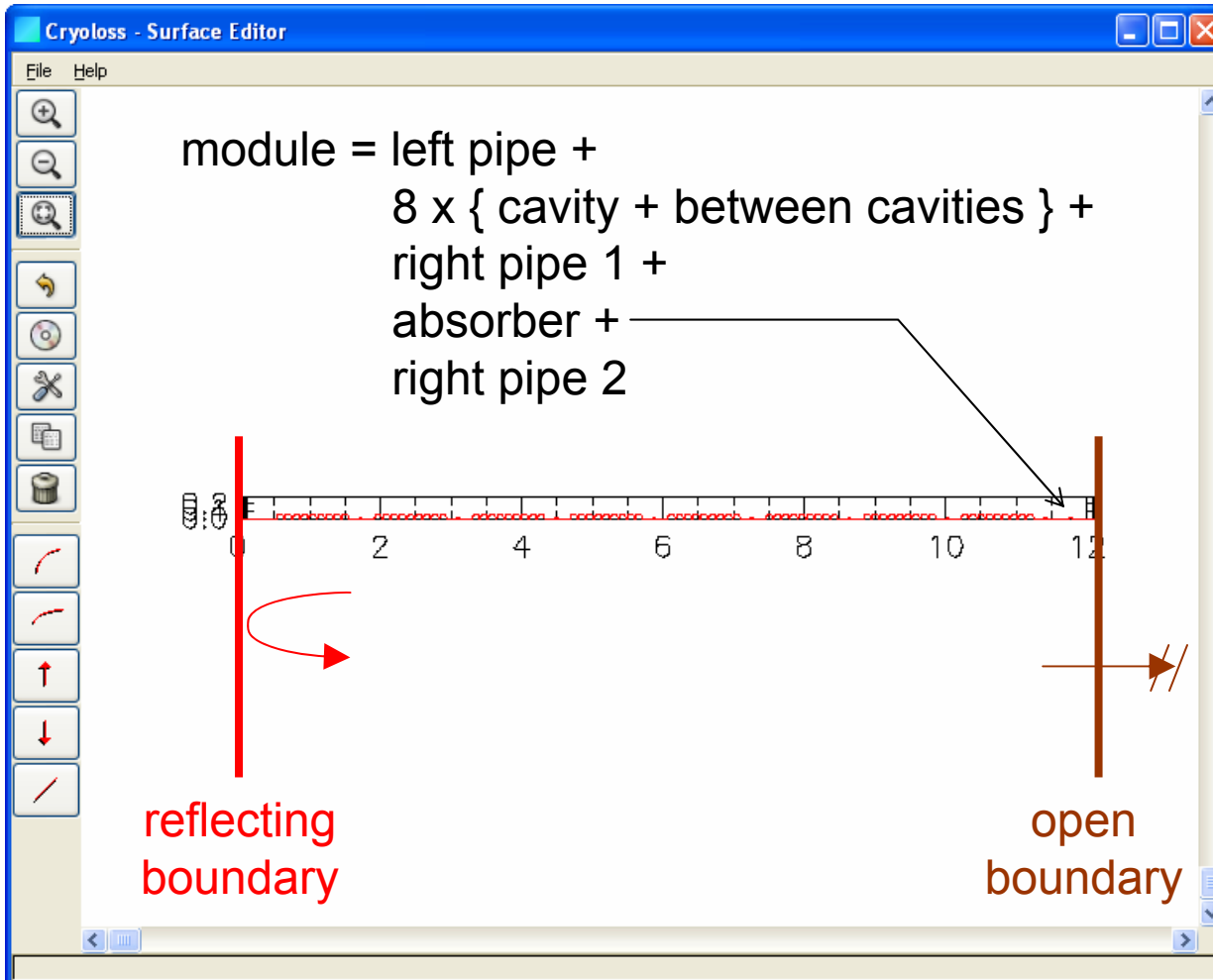

≈ open-ACC5-| -ACC6-open



absorber 1  
perfect cu  
f = 10 GHz

## 4. Cryoloss Results XFEL

averaged number of hits per surface

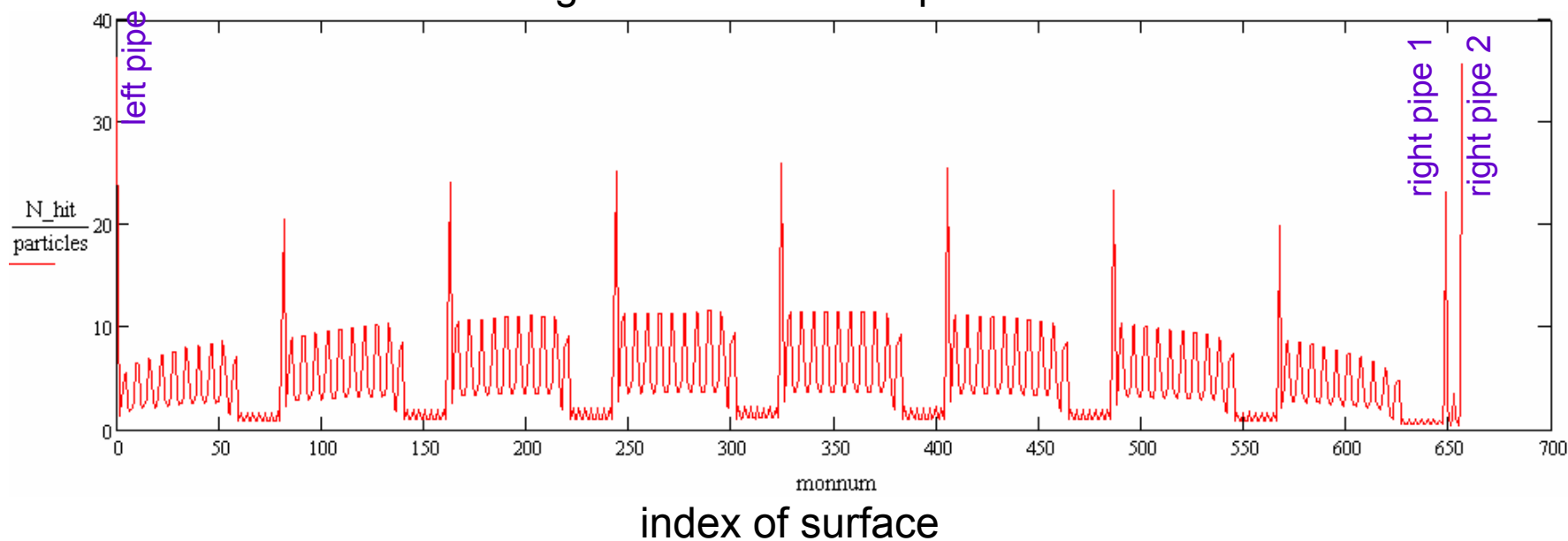

stopping criterion:  $P_{wave} < 10^{-4} P_{initial\ wave}$

$$\rightarrow \frac{\sum N_{hit}}{surfaces} = 3226$$

particles



absorber 1  
perfect cu  
f = 10 GHz

## 4. Cryoloss Results XFEL

averaged number of hits per surface

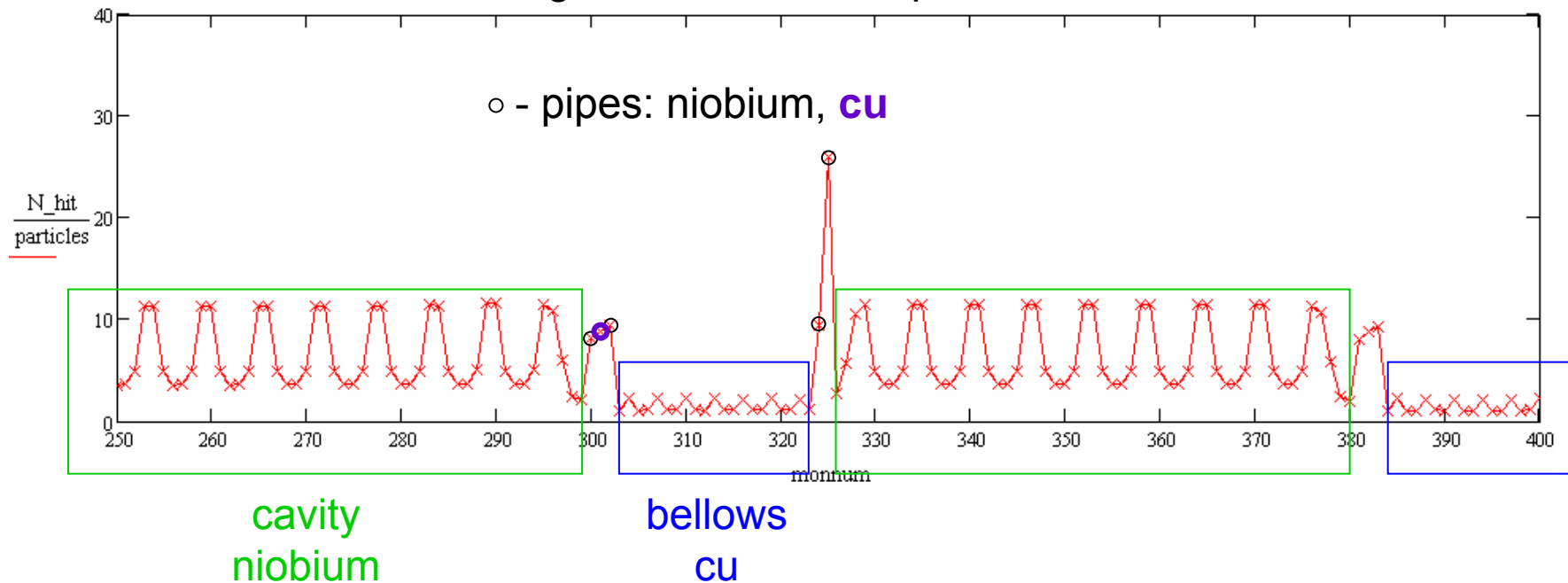

absorber 1  
perfect cu  
f = 10 GHz

## 4. Cryoloss Results XFEL

averaged number of hits per surface

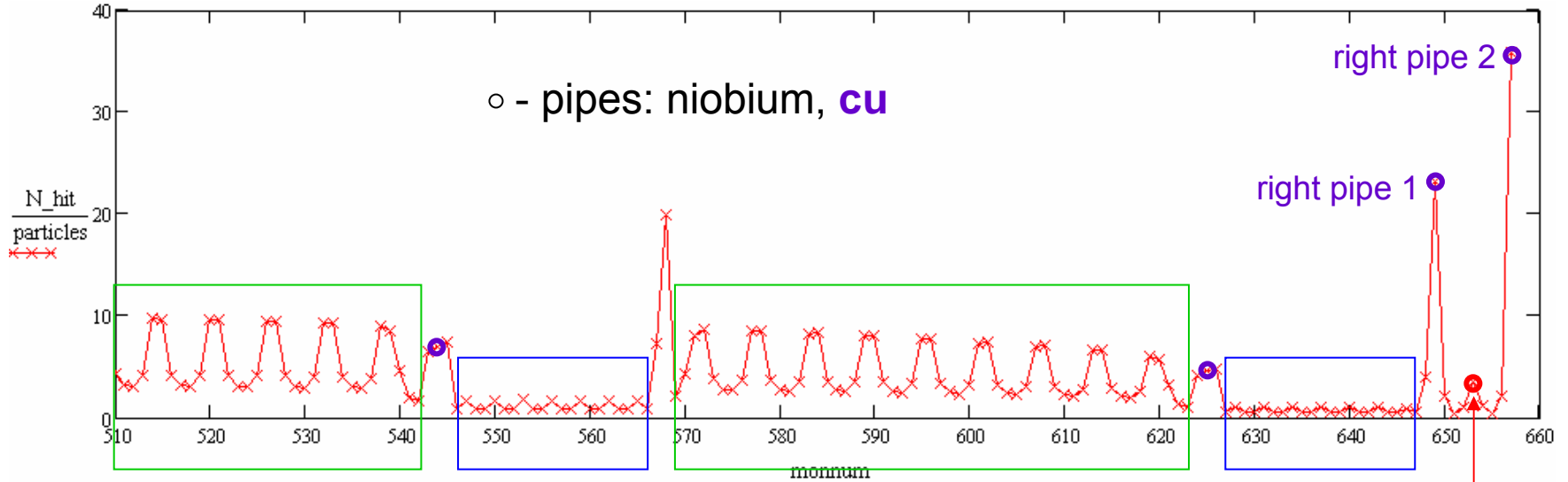



absorber 1  
perfect cu  
f = 10 GHz

## 4. Cryoloss Results XFEL

averaged number of hits per surface

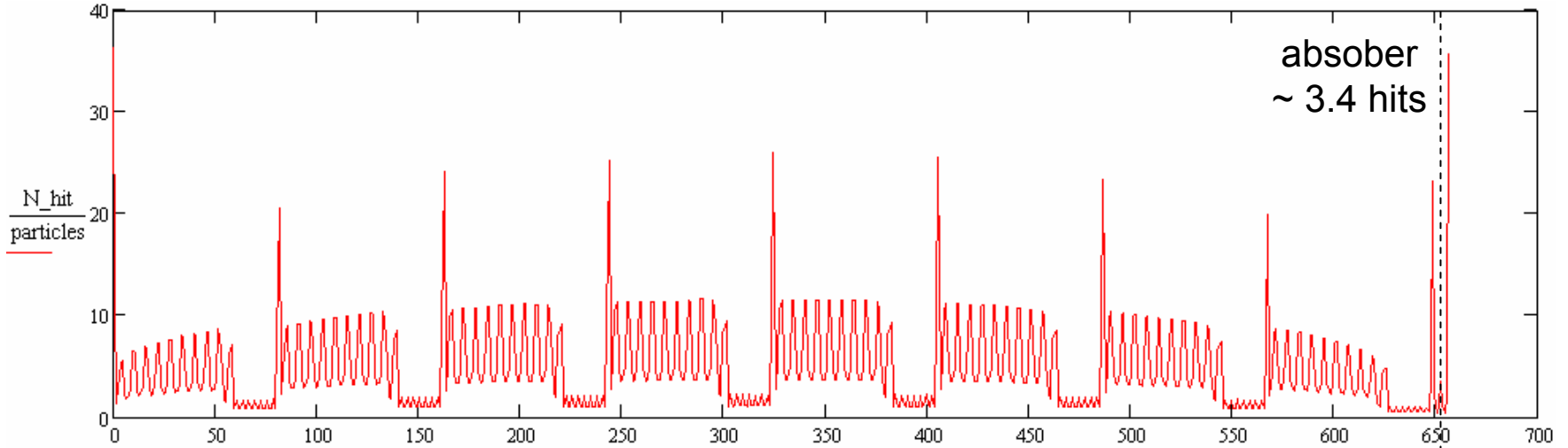

losses per surface

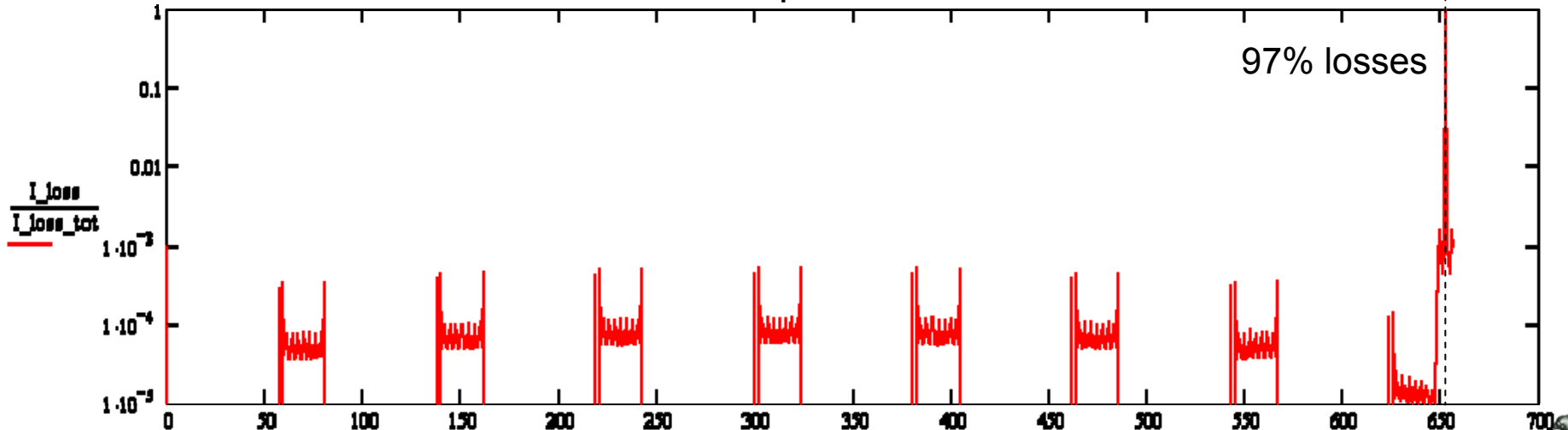

absorber 1  
perfect cu

## 4. Cryoloss Results XFEL

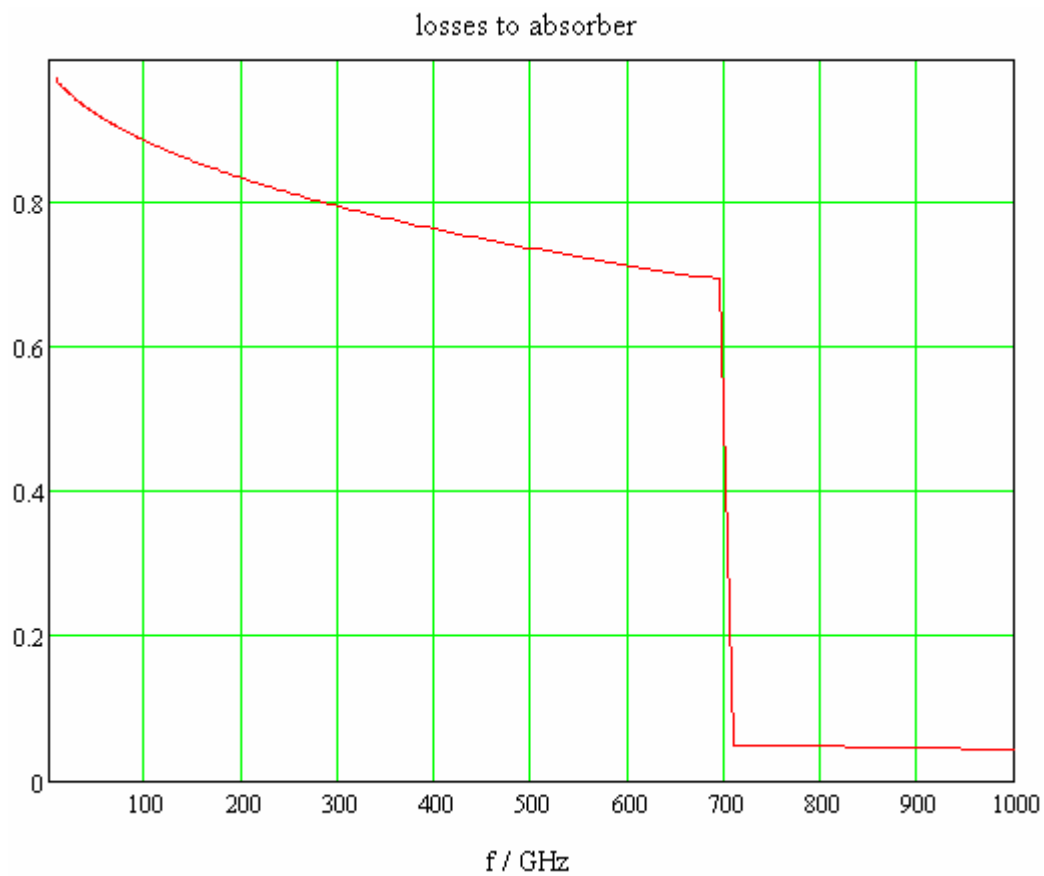

absorber 1  
perfect cu

## 4. Cryoloss Results XFEL

bunch length = 25  $\mu\text{m}$

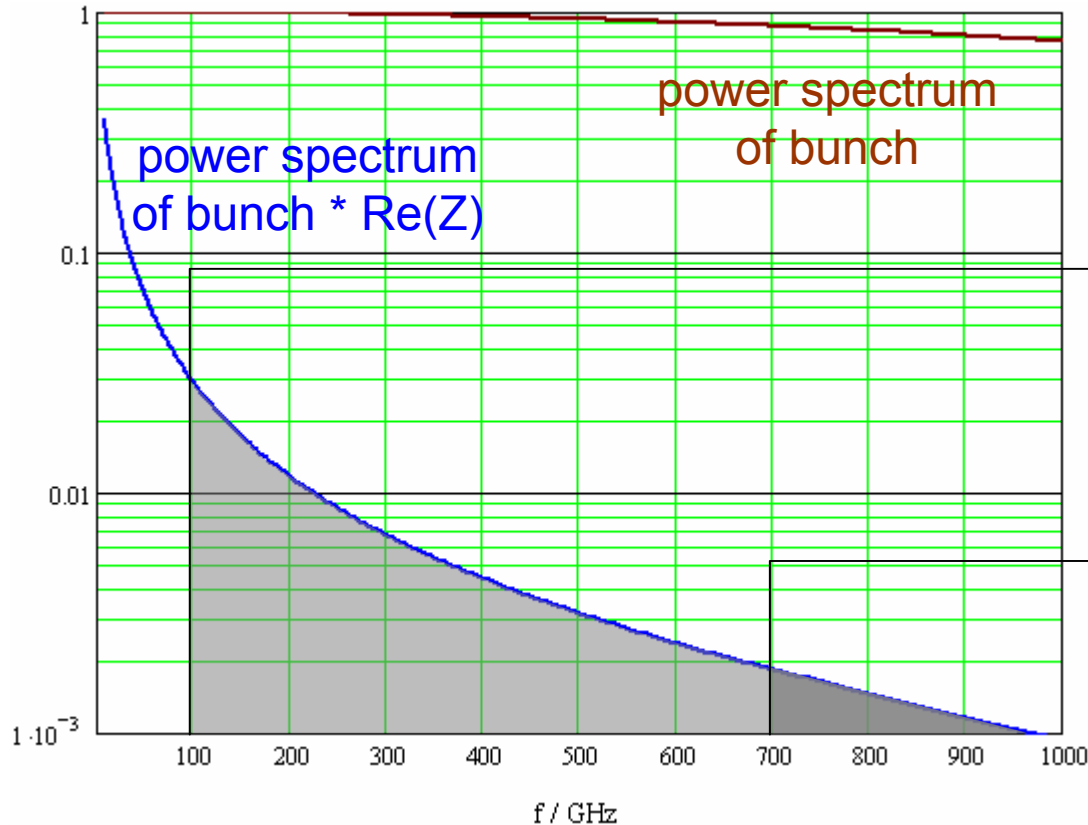

$$\frac{\int_{100\text{GHz} \cdot 2\pi}^{\infty} P^{(\sigma)} \text{Re}\{Z\} d\omega}{\int_0^{\infty} P^{(\sigma)} \text{Re}\{Z\} d\omega} \approx 0.258$$

$$\frac{\int_0^{700\text{GHz} \cdot 2\pi} P^{(\sigma)} \text{Re}\{Z\} d\omega}{\int_0^{\infty} P^{(\sigma)} \text{Re}\{Z\} d\omega} \approx 0.046$$

absorber efficiency:  $\eta_{\text{abs}} = \frac{\int \eta(\omega) P^{(\sigma)}(\omega) \text{Re}\{Z(\omega)\} d\omega}{\int P^{(\sigma)}(\omega) \text{Re}\{Z(\omega)\} d\omega} = 83 \%$

with  $\eta_{\text{abs}}(\omega) = 0$  for  $\omega > 700\text{GHz} \cdot 2\pi$



# 4. Cryoloss Results XFEL

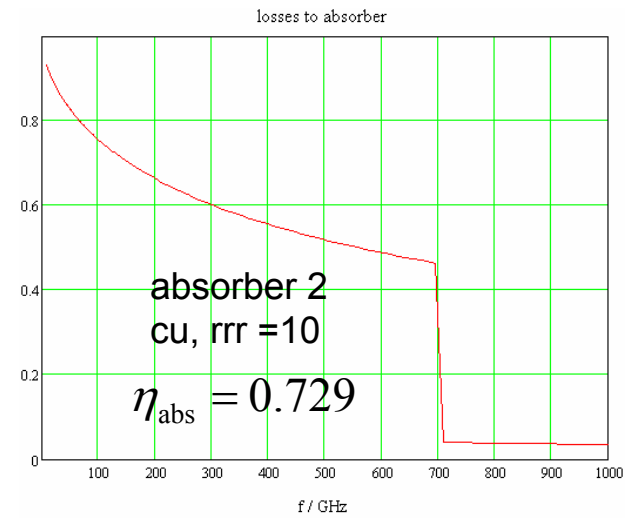
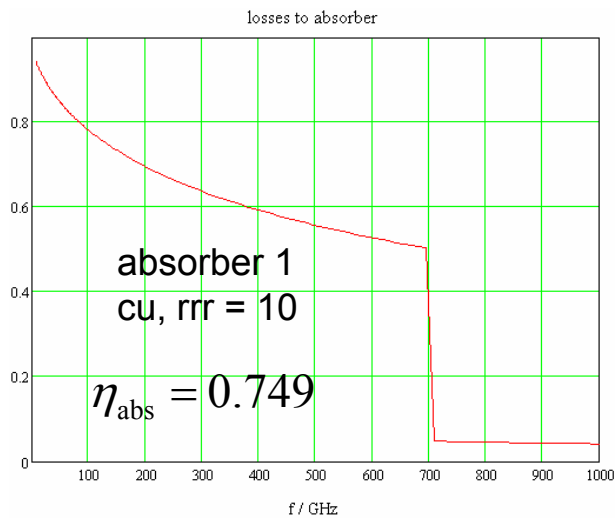
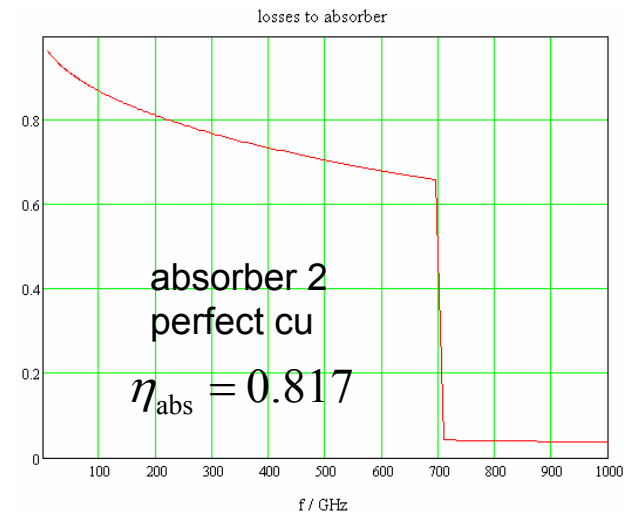
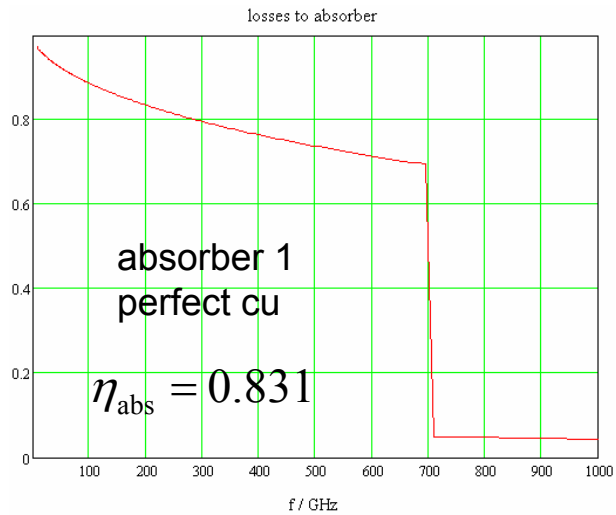

## 4. Cryo Loss Results

### XFEL – working hypothesis of TDR

absorption efficiency  $\approx 90\%$   
safety margin 10%

→ assumed absorption efficiency = 80 %

but the calculations with low rrr cu  
give lower results !

significant influence of  
physics (of field propagation) and  
material properties  
that are not well known

---

	10x3000 bunches / sec	30x3000 bunches /sec
single bunch losses =	4.6 W	13.8 W
2K losses (for $\eta = 0.75$ ) =		
$(1 - \eta) \times$ single bunch losses =	1.2 W	3.5 W



## 4. Cryoloss Results FLASH

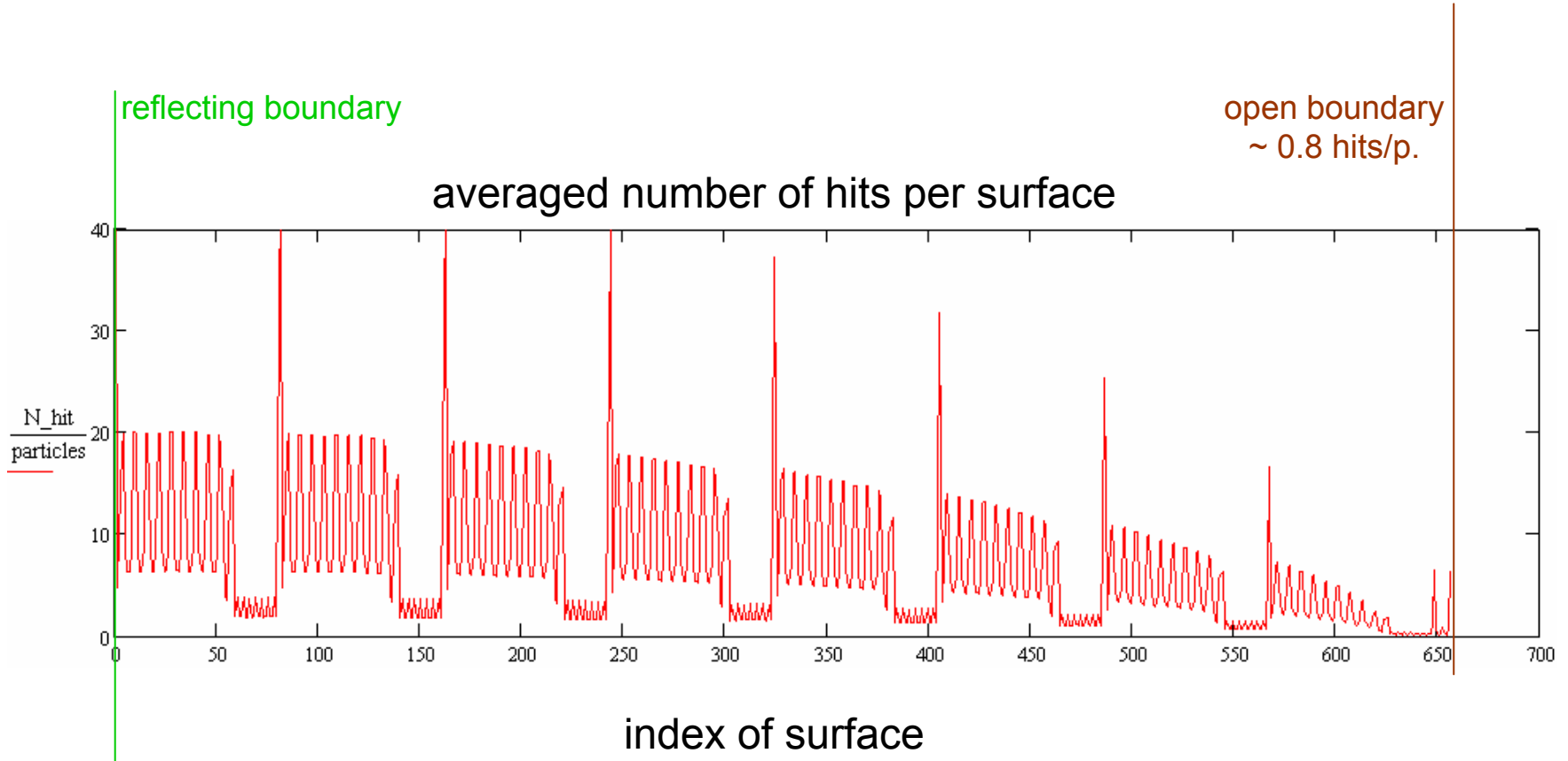

stopping criterion:  $P_{wave} < 10^{-4} P_{initial\ wave}$

$$\rightarrow \frac{\sum_{surfaces} N_{hit}}{particles} \approx 4100$$



absorber 2  
perfect cu  
f = 10 GHz

## 4. Cryoloss Results FLASH

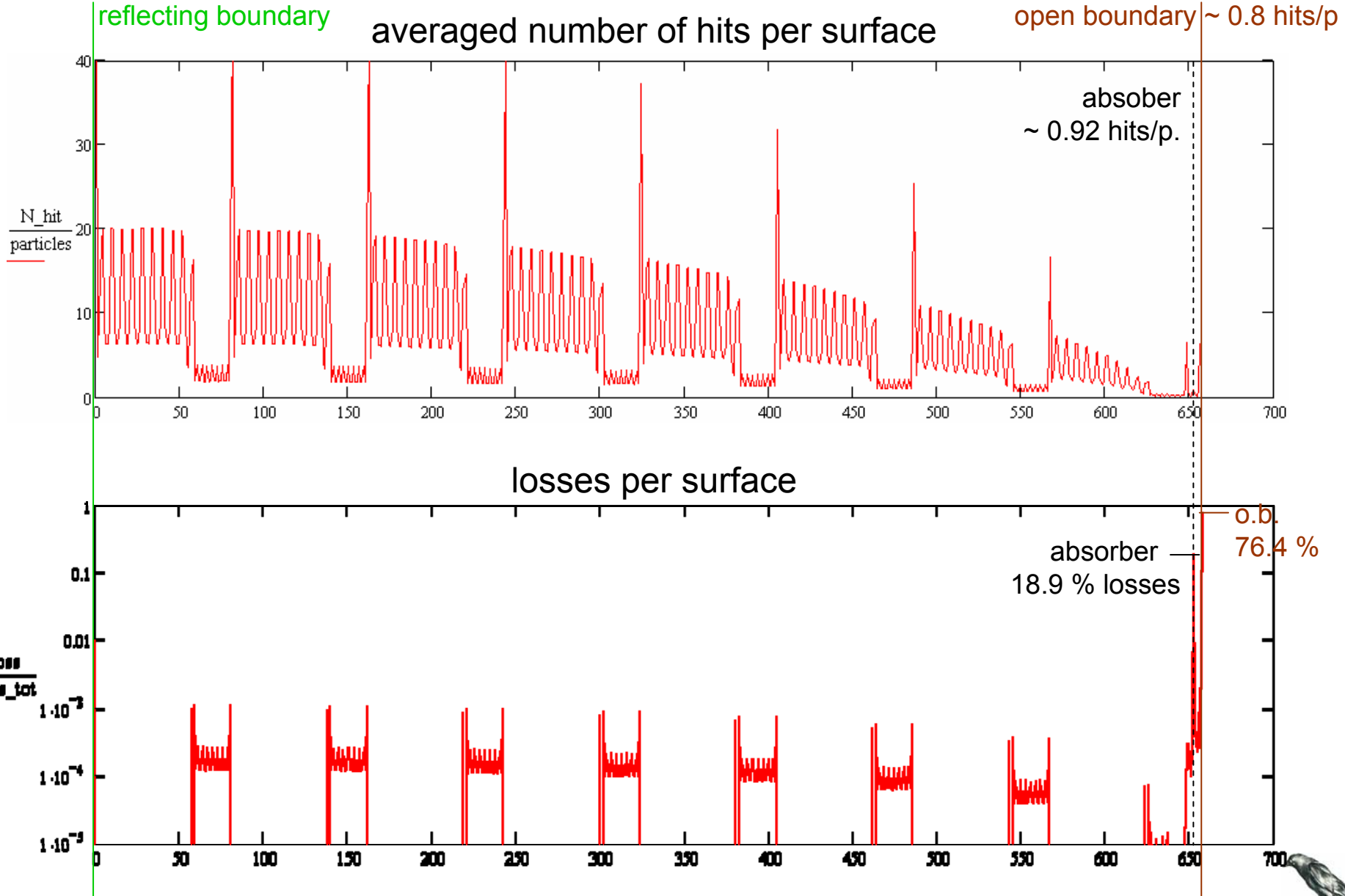

bunch length = 25  $\mu\text{m}$   
bunch charge = 1nC

## 4. Cryoloss Results FLASH

absorber + open b.

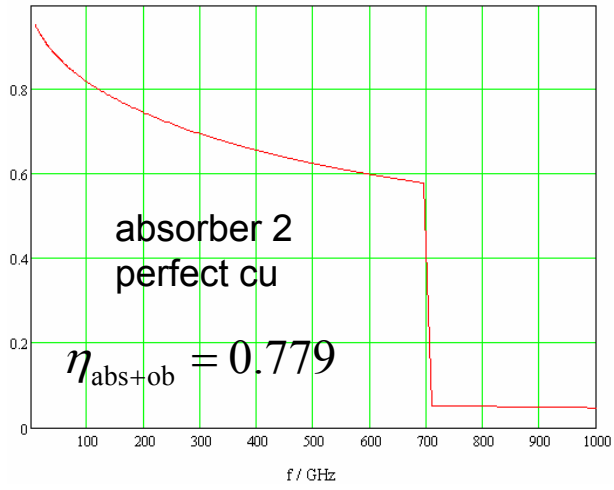

losses to absorber

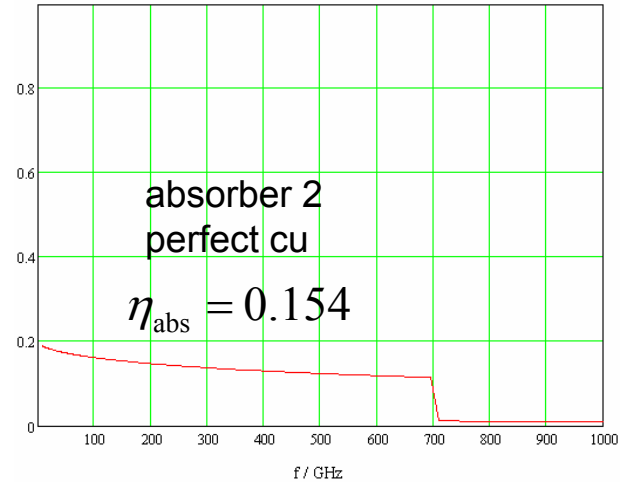

absorber + open b.

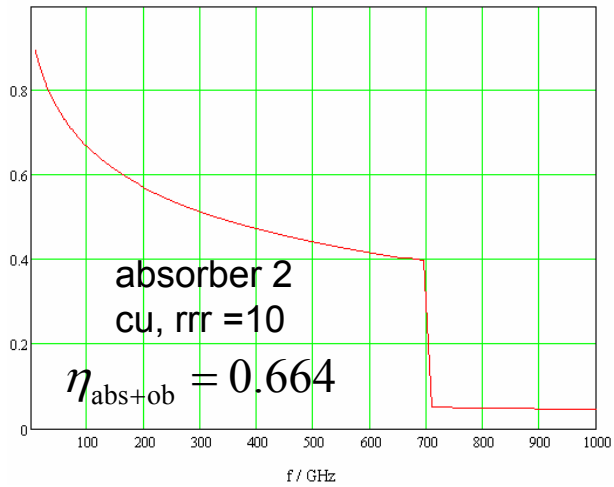

losses to absorber

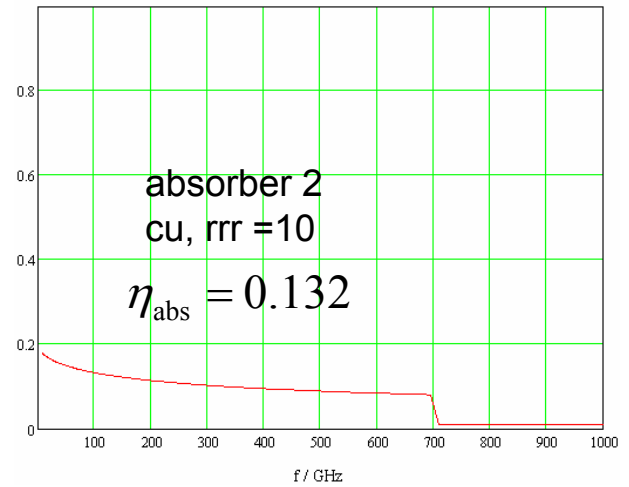



## 4. Cryoloss Results + FLASH long bunch operation

Logbook entry: [/TTFelog/data/2007/42/21.10\\_a](#)



21.10.2007 19:07 tfflinac

Main linac parameters

### Laser

Number of bunches ..... 780  

---

Bunch frequency ..... 1000 kHz  
Macropulse rep'rate .... 5.0 Hz  
Flashlamp current ..... 2.20  
Flashlamp start time ... 2.29 ms  
Attenuator SP ..... 18144  
Iris diameter ..... 1.95 mm  
Piezo Voltage ..... 4.212 V

### Gun

Feedforward/Feedback ... on/on  
Pfld SP ..... 3.35  
Pfld RBV ..... 3.38  
Phase SP ..... -96.47 deg  
Phase RBV ..... -147.26 deg  
Pfld (peak) ..... 3.563 MW  
Prefl (peak) ..... 1.343 MW  
Pfld (sample point 700) 3.382 MW  
Prefl (sample point 700) 0.012 MW  
Flat top ..... 850 us  
Water temperature SP ... 60.57 deg C  
Main solenoid ..... 294.04 A  
Bucking coil ..... -26.51 A  
Gun dipole ..... 0.000 A  

---

Charge 3GUN(T1) ..... 0.55 nC

(3 nC)

single bunch losses  $P_{\text{single bunch}} = (780 \cdot 5\text{Hz}) q^2 k_{\text{module}}$

$$k_{\text{module}} \approx 1.53 \cdot 10^{14} \frac{\text{V}}{\text{C}} \rightarrow P_{\text{single bunch}} \approx 0.18 \text{ W} \quad (5.4\text{W})$$

losses to absorber: "perfect" Cu  $P_{\text{single bunch}} \eta_{\text{abs}} \approx 0.028 \text{ W} \quad (0.83\text{W})$

RRR=10 Cu  $P_{\text{single bunch}} \eta_{\text{abs}} \approx 0.024 \text{ W} \quad (0.71\text{W})$



EU contract number RII3CT-2003-506395

CARE Conf-05-024-SRF



## SRF

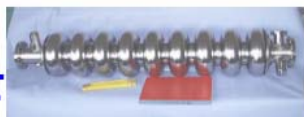

### RRR OF COPPER COATING AND LOW TEMPERATURE ELECTRICAL RESISTIVITY OF MATERIAL FOR TTF COUPLERS

M. Fouaidy, N. Hammoudi, IPN Orsay, France  
S. Prat, LAL, France

#### Abstract

In the frame of the R&D program on the TTF III main RF coupler, IPN Orsay developed in close collaboration with LAL institute, a dedicated facility for the electrical characterization of different materials at low temperature. This apparatus was used for measuring the electrical resistivity versus temperature (4.2 K- 300K) of various samples produced in the industry. These tests were performed in order to compare the RRR of the samples, qualify and find the optimum parameters for the coating process. Seven flat samples were tested in a saturated liquid helium bath under -1013 mBar pressure: measurements were performed on bare 316L samples, nickel coated 316L samples, copper coated 316L samples with a nickel under layer. We investigated, in particular, the effect of vacuum annealing at 400°C on the RRR of the copper coating. Our experimental data are compared to previous results reported by other groups, empirical correlation and a good agreement was found. Finally, the tested samples fulfil the TTF III design parameters requirements in terms of heat loads to the refrigerator at 2 K, 4 K and 70 K.

Contribution to the SRF 2005, Ithaca, New York, USA

Work supported by the European Community-Research Infrastructure Activity under the FP6 "Structuring the European Research Area" programme (CARE, contract number RII3-CT-2003-506395).

EU contract number RII3CT-2003-506395

CARE Conf-05-024-SRF

Using the equation 4 and the data shown in Fig.10, we have deduced the electrical resistivity of the copper coating (Fig. 11).

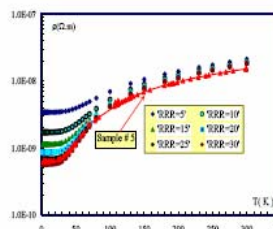

Fig. 11: Electrical resistivity of the copper coating. Our data are compared to the theoretical  $\rho_{Cu}$  versus T curve which was calculated using the following empirical correlation:

$$\rho(T) = RRR \cdot \rho(273) + b \cdot \exp\left(\sum_{i=1}^n a_i \cdot (Ln(T))\right) \quad (5)$$

Where:  $\rho(273) = 1.7110^{-8} \Omega \cdot m$  is the electrical resistivity of copper at the ice point temperature  $T=273$  K,  $b$  and  $a_i$  ( $0 < i < n$ ) are empirical constants given in the Table 4.

Table 4: Values of the empirical correlation parameters

Constant	Value
b	$10^{-6} \Omega \cdot m$
$a_0$	-9.600976
$a_1$	-12.52445
$a_2$	8.309361

The shape of our experimental data and the theoretical curves given by expression (5) for different RRR values are similar. Moreover, the comparison of the data to the correlation lead to a theoretical RRR=25-30. Resolution of the electronics used for the tests is not sufficient for the precise measurement of the electrical resistivity of the nickel sub layer. Consequently we have to assume reasonable values of this parameter in order to deduce the RRR of copper coating from our experimental data. The summary of RRR measurements for all the samples tested are illustrated in Table 5.

For the samples without any heat treatment (i.e. as received), the RRR of Cu coating are in the range 20-46 if we use a realistic value of Ni RRR (i.e. RRRNi=1). Moreover the RRR data of sample #1 are in good agreement with the empirical correlation (5): the measured value of copper coating (RRR=20) is consistent with that given by the correlation (RRR=25-30).

Furthermore, the vacuum annealing at 400°C during one hour increases the RRR of copper coating by a factor ~6.

Table 5: Summary of copper coating RRR results.

Sample	Ni effect neglected	RRR <sub>Ni</sub> =1	RRR <sub>Ni</sub> =300
#1 As received	19.8	20.4	11.2
#1 Vacuum Annealed@ 400° during 1h00	113	117	107
#5 As received	23.7	24	21
#6 As received	45.5	45.9	43

#### CONCLUSION

In the frame of the CARE-SRF project WP7 R&D program aimed at development and fabrication in the industry of thirty TTF III power couplers, we designed an apparatus dedicated to the measurement of the electrical resistivity of materials at low temperatures. Several stainless steel samples coated with copper were characterized at room temperature (adhesion and thickness of the coating, impurity content, roughness...). The electrical resistivity of different materials (stainless steel, Cu coating, Ni under layer) were measured in the range 4.2 K - 300 K. The RRR of Cu coating was deduced from these data: 1) for as received samples the RRR values are in the range 20-46, 2) the vacuum annealing at 400°C during one hour increases the RRR of copper coating by a factor ~6. Moreover, our electrical resistivity data are compared to previous results reported by other groups, theoretical values, empirical correlation and a good agreement was found. Finally, the tested samples fulfil the TTF III design parameters requirements in terms of heat loads to the refrigerator at 2 K, 4 K, and 70 K.

#### ACKNOWLEDGEMENTS

We acknowledge the support of the European Community-Research Infrastructure Activity under the FP6 "Structuring the European Research Area" programme (CARE, contract number RII3-CT-2003-506395)

#### REFERENCES

- [1] T. Garvey et al. 'The Tesla High Power Coupler Program at Orsay', Proc. SRF2003, 8 -12 September 2003, Travemünde, German.
- [2] Dohlus M., Kostin D.Möller W.-D., 'Tesla RF power Coupler Thermal Calculations', Proc. of LINAC 2004 Lübeck, Germany, 16 - 20 August 2004.
- [3] A. F. Clark et al., Cryogenics, august 1970, pp 295-305.