

HOM-based Beam and Cavity Diagnostics in 1.3 GHz SC Cavities at FLASH

Junhao Wei (NSRL/USTC, DESY)

Outline

- A brief Introduction to FLASH and Higher Order Modes
- HOM-based beam position measurement
- Long-term HOM-based beam phase measurement
- HOM-based cavity tilt measurement
- Summary

- **A brief Introduction to FLASH and Higher Order Modes**
- HOM-based beam position measurement
- Long-term HOM-based beam phase measurement
- HOM-based cavity tilt measurement
- Summary

FLASH

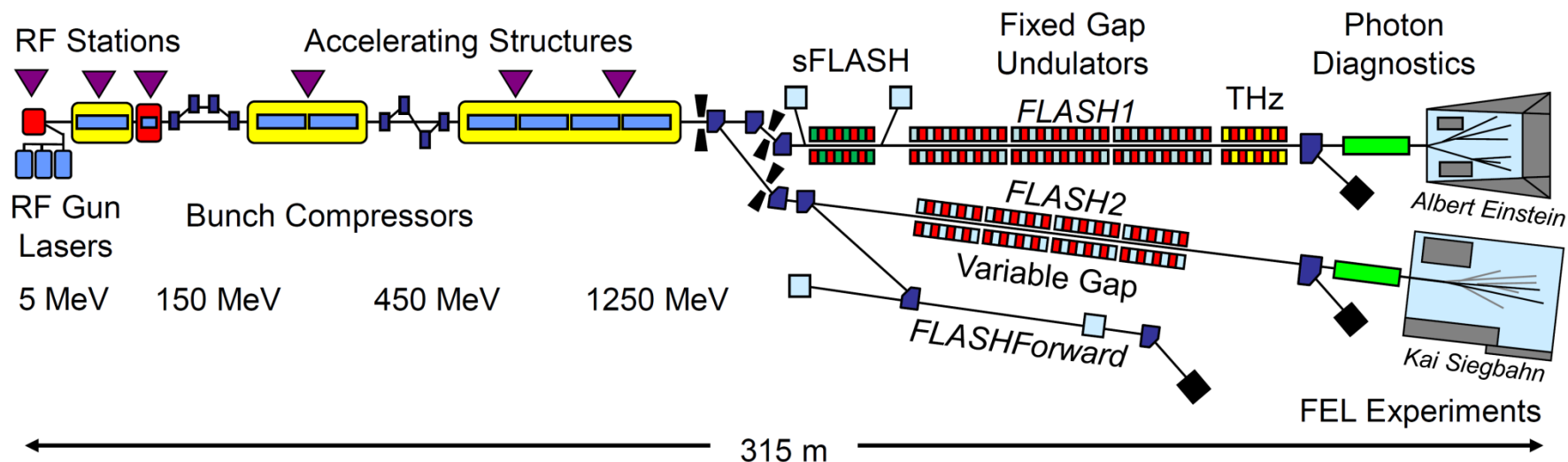

Table 1: FLASH Parameters 2016/2017

electrons :	FLASH1	FLASH2		photons :	FLASH1	FLASH2	
beam energy	350 - 1250	400 - 1250	MeV	λ (fund.)	4.2 - 51	4 - 90	nm
charge	0.1 - 1.2	0.02 - 1	nC	pulse energy (\star)	1 - 500	1 - 1000	J
emittance (\times)		1.4	μm	pulse duration (fwhm)	<30 - 200	< 10 ^(*) - 200	fs
peak current (\dagger)		0.8 - 2.5	kA	spectral width (fwhm)	0.7 - 2.0	0.5 - 2.0	%
energy spread (\circ)	0.2	0.5	MeV	peak power		1 - 5	GW
bunches / train (\ast)		1 - 500		peak brilliance		10 ²⁸ - 10 ³¹	(+)
bunch spacing		1 - 25	μs	photons /pulse		10 ¹¹ - 10 ¹⁴	
train rep. freq.		10	Hz				

(\times) : gun, $\beta\gamma\epsilon_{x,y}$, 1 nC, on-crest, 90% rms

(\dagger) : after compression (\circ) : entrance undulator

(\ast) : up to 600 (FLASH1 xor 2) possible in 2017

(\star) : average, single pulse (\ast) : estimated

(+) : photons/(s mm² mrad² 0.1%bw)



Wakefields

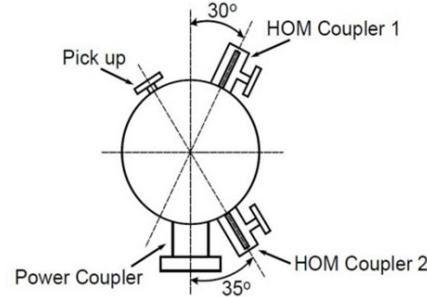
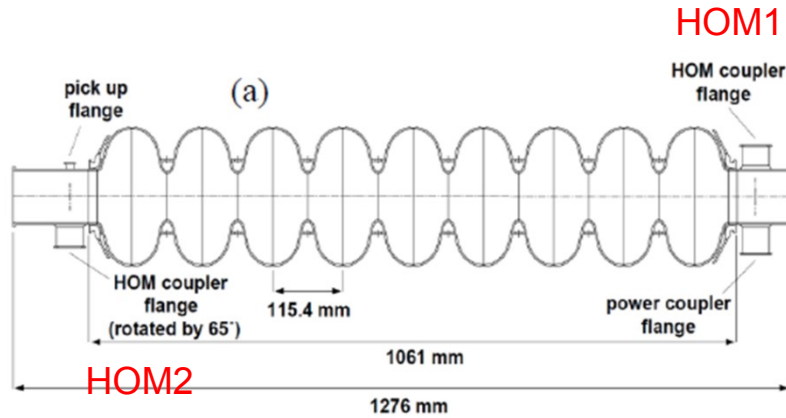

- When a beam passes through a cavity, wakefields are excited. These fields are classified into monopole, dipole, quadrupole etc. modes according to their symmetry.

Longitudinal wake potential from monopole modes:

$$W_{\parallel} \cong - \sum_n \omega_{0n} \left(\frac{R}{Q}\right)^{(0n)} \cos\left(\frac{\omega_{0n}S}{c}\right) H(s) \mathbf{e}_z,$$

Transverse wake potential from dipole modes

$$W_{\perp} \cong r_1 c \sum_n \left(\frac{R}{Q}\right)^{(1n)} \sin\left(\frac{\omega_{1n}S}{c}\right) H(s) [\cos(\theta_1 - \theta_2) \mathbf{e}_r + \sin(\theta_1 - \theta_2) \mathbf{e}_{\theta}].$$

- The N-cell structure behaves like a system composed by N coupled oscillators with N coupled multi-cell resonant modes

$$\frac{\omega_m^2}{\omega_0^2} = 1 + 2k \left(1 - \cos \frac{\pi m}{n}\right)$$

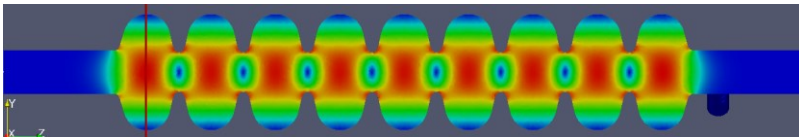
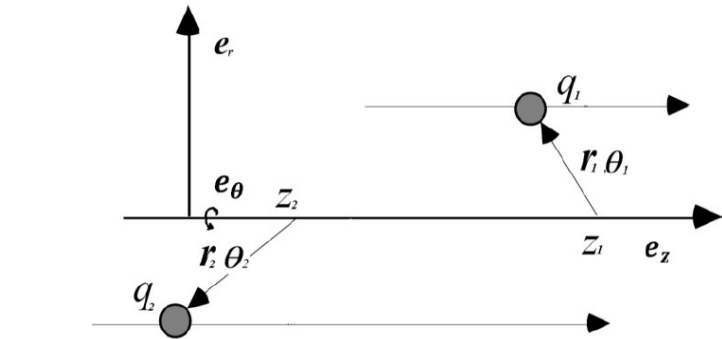

Modes in a Pill Box Cavity

- **TM₀₁**

- Electric field is longitudinal and concentrated near axis
- Magnetic field is concentrated at outer cylindrical wall

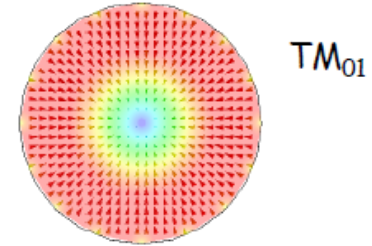

- **TM_{0n}**

- Monopole modes that can couple to the beam and exchange energy

- **TM_{1n}**

- No longitudinal magnetic field
- Dipole modes that can deflect off-axis beams
- Have two polarizations

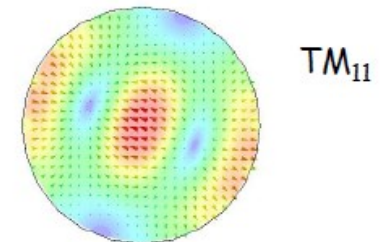

- **TE_{1n}**

- No longitudinal electric field
- Dipole modes that can deflect off-axis beams
- Have two polarizations

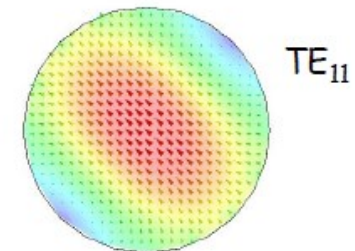

HOM Spectrum

TESLA Cavity (1.3 GHz)

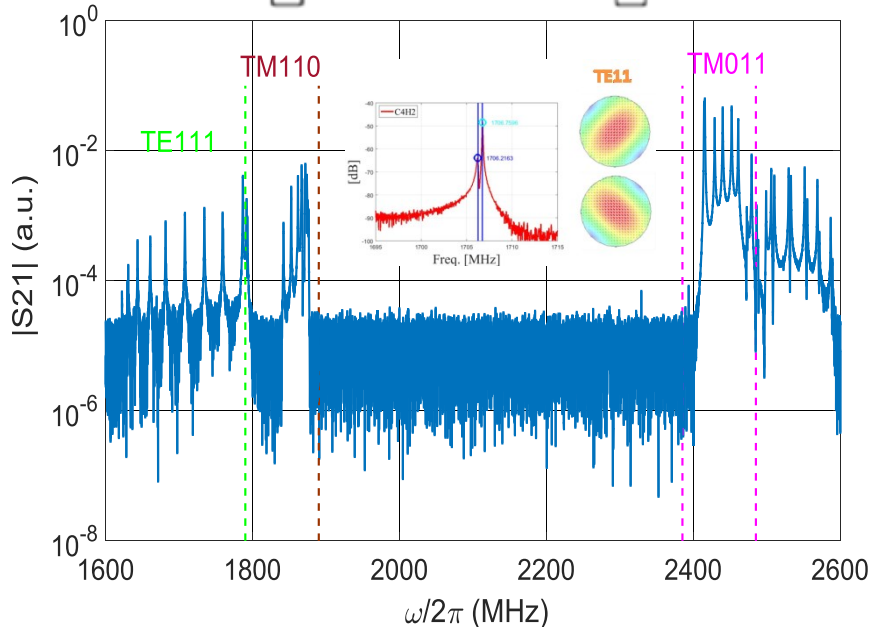
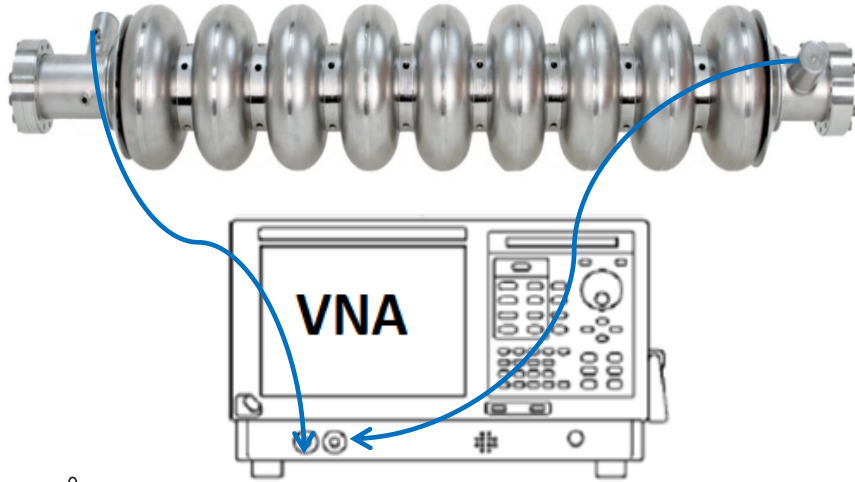

■ Monopole bands

- 2.38 to 2.45 GHz (TM011)
 - Some modes with $R/Q \sim 75$ Ohms
 - Used for phase measurements

■ Dipole Bands

- 1.63-1.8 GHz (TE111)
 - TE111-6, at 1.7GHz has strong coupling to beam
 - Used for beam position measurements
 - Two peaks indicate two polarizations in cavity
- 1.83-1.9 GHz (TM110)
 - Some modes have strong coupling to beam
 - The band is more compact

- A brief Introduction to FLASH and Higher Order Modes
- **HOM-based beam position measurement**
- Long-term HOM-based beam phase measurement
- HOM-based cavity tilt measurement
- Summary

Principle

- The strength of the excited dipole modes depends linearly on the beam charge and transverse position: $q \cdot r \cdot (R/Q)$.

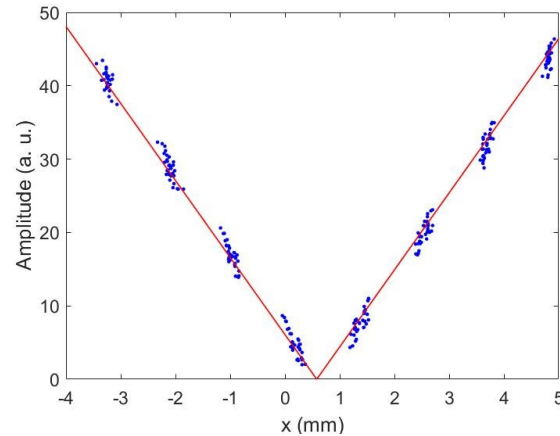

- Each dipole mode has two polarizations correlating the beam offset in two directions.

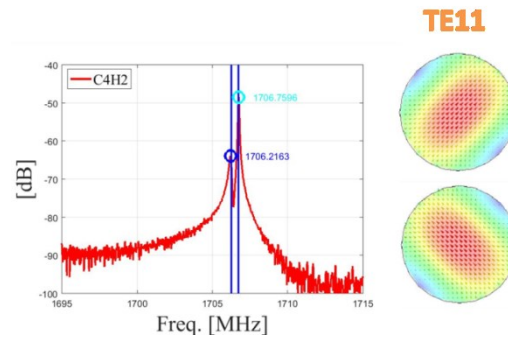

- The HOM couplers extract HOM signals which can be used for data analysis.
- TE₁₁₁₋₆, at 1.7GHz has strong coupling to beam and is selected by the electronics.

Measurement Setup

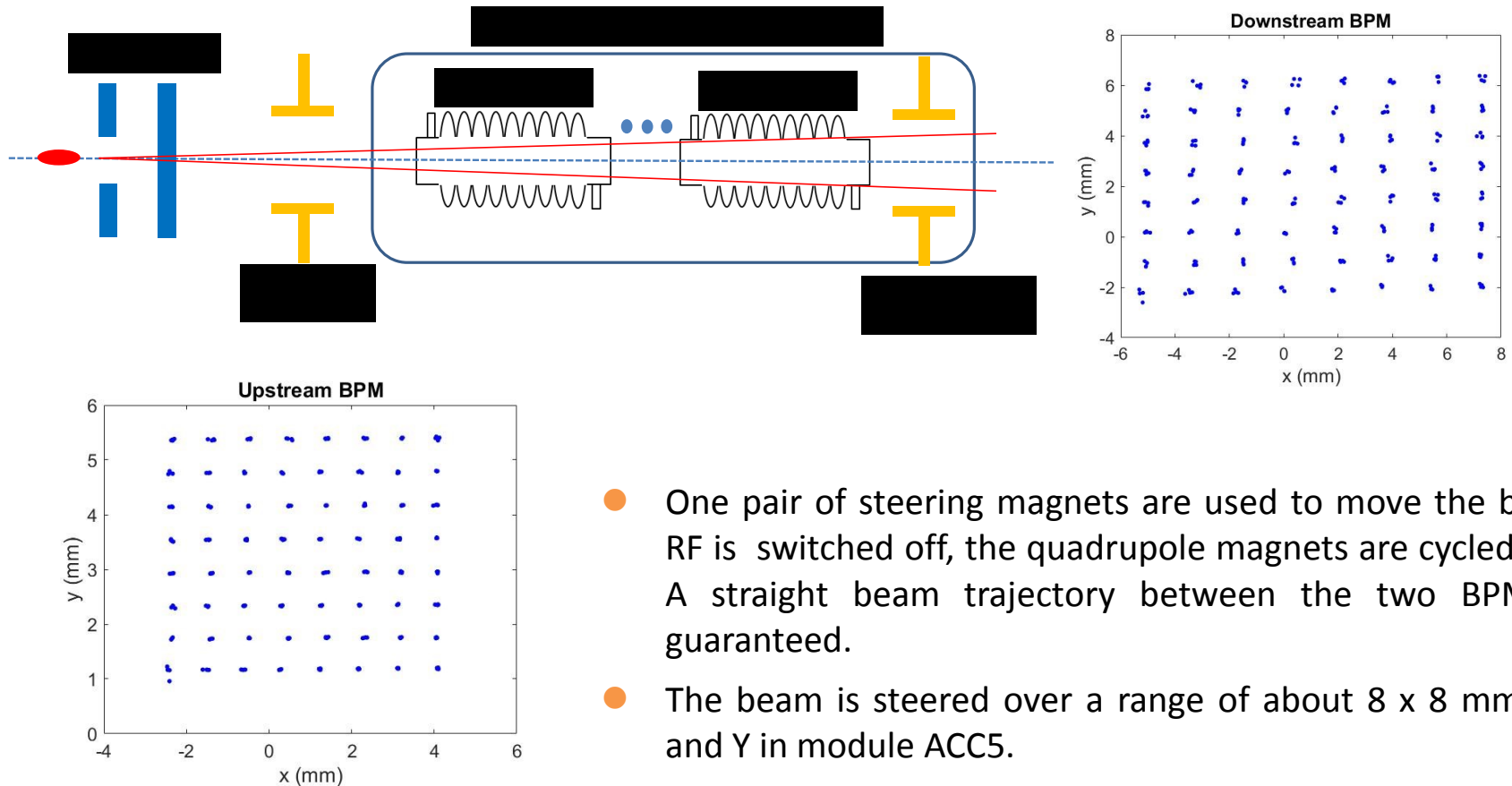

- One pair of steering magnets are used to move the beam. RF is switched off, the quadrupole magnets are cycled to 0. A straight beam trajectory between the two BPMs is guaranteed.
- The beam is steered over a range of about 8 x 8 mm in X and Y in module ACC5.
- Two BPMs located upstream and downstream of the module give the interpolated beam positions in the cavities.

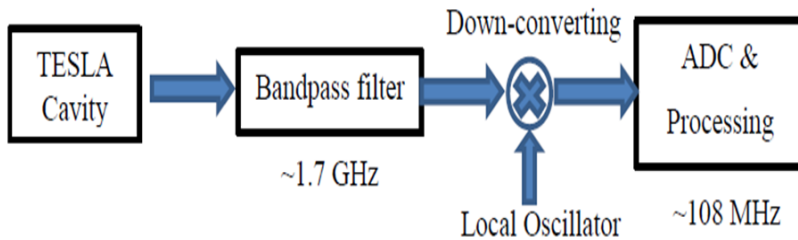

- The data acquisition system filters the HOM signal at 1.7 GHz with a 20 MHz narrow bandpass and down-mixes to 20 MHz IF (intermediate frequency), which is then sampled at about 108 MHz by an ADC.
- The two peaks in the spectrum correspond to the two polarizations of the dipole mode.

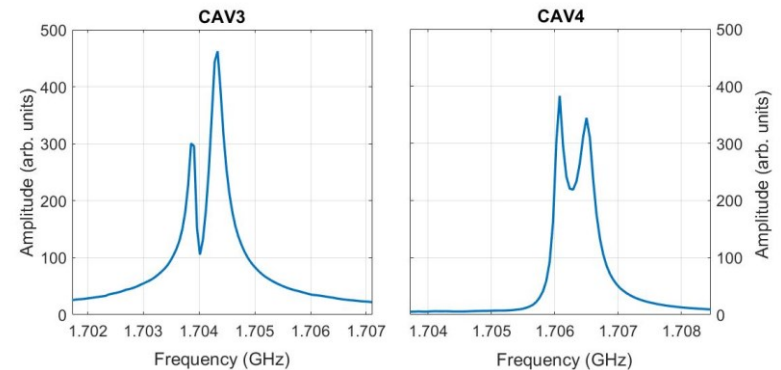
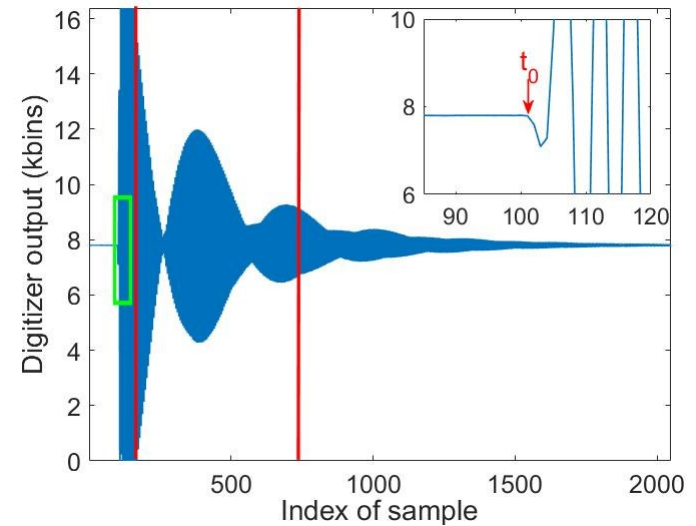

J. Frisch, N. Baboi, N. Eddy, et al., *AIP Conf. Proc.*, 868, 313 (2006).

Standard SVD Method

- SVD (Singular Value Decomposition) is a useful method to solve the linear regression model. It can find the latent components in the HOM data that have high correlation with the beam position to reduce the noise and matrix dimension.

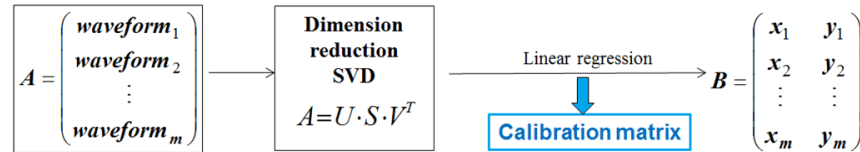

- Singular Values.

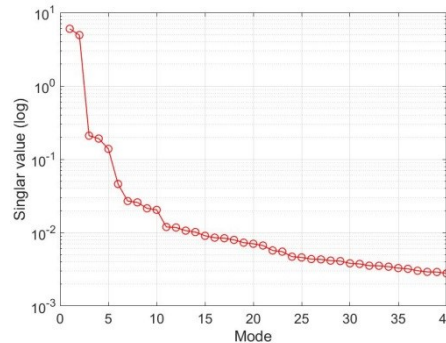

- Reconstructed signal (left) and estimated noise (right) by SVD (noise RMS: 24.3 bins, 2% of the signal).

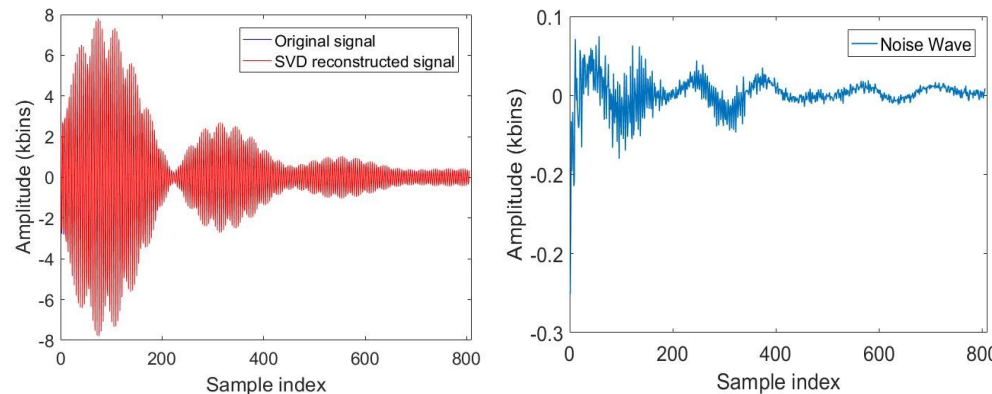

HOMBPM with SVD Method

❖ HOMBPM Calibration (April 4th, 2018)

Calibrated beam positions in ACC5-CAV4

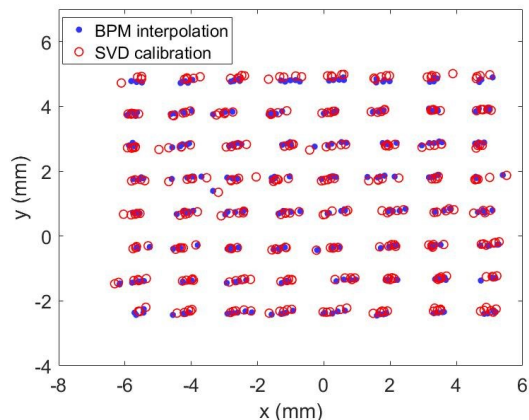

- Calibration data was measured on 4 April 2018, in module ACC5.
- The RMS error between the beam positions interpolated from the two BPMs (blue) and the HOM calibrated beam positions (red) is **0.13 mm in x and 0.09 mm in y**.

❖ Beam Position Prediction (May 4th, 2018)

Predicted beam positions in ACC5-CAV4

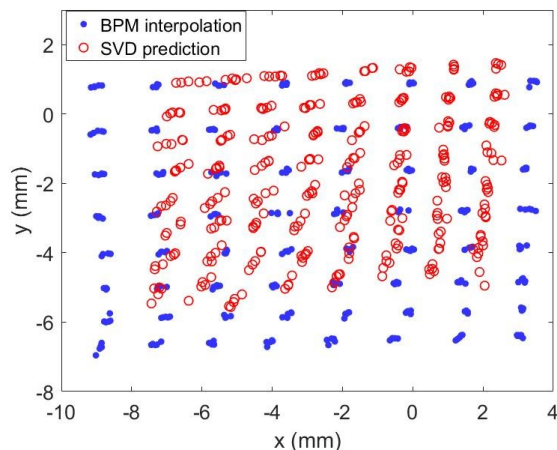

- The prediction data was measured on 4 May 2018, in module ACC5.
- The RMS error is **1.17 mm in x and 1.48 mm in y**.
- As we can see, the RMS error has increased significantly over a month. The HOMBPM loses its accuracy for beam position measurement with the SVD method.

New Signal Fitting Method

- The dipole mode signal mainly consists of two components corresponding to the two signal peaks in the frequency domain. Signal fitting can give the physical information, such as the phase, independent amplitude and decay constant of each peak.

$$W(t) = a_0 + a_1 \sin [\omega_1(t - t_0) + \varphi_1] e^{-\frac{(t-t_0)}{\tau_1}} + a_2 \sin [\omega_2(t - t_0) + \varphi_2] e^{-\frac{(t-t_0)}{\tau_2}},$$

- Fitting waveform (left) and the difference (right) between it and the original signal. The coefficient of determination (R2) is over 0.99 and the RMS error of the difference waveform is 19 bins .

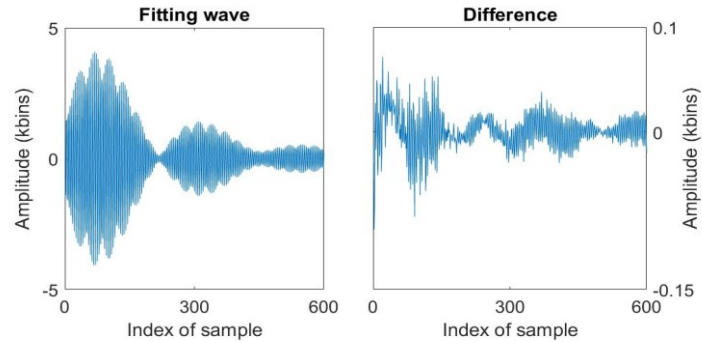

- Dipole mode amplitude (left) and phase (right) distribution.

$$\tilde{\varphi} = (-1)^{\text{round}(\frac{\varphi_{1,2} - \varphi_{1,2}^{\text{ref}}}{\pi})}$$

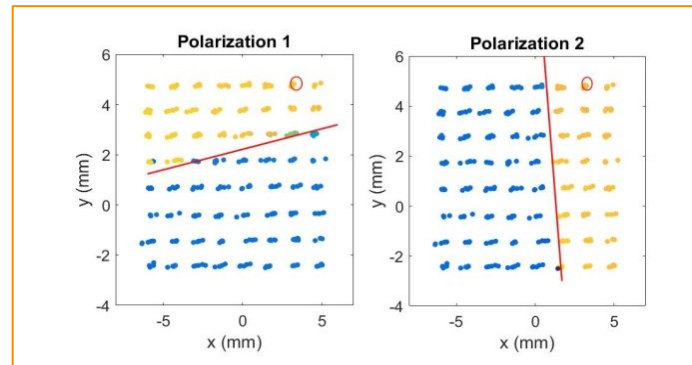
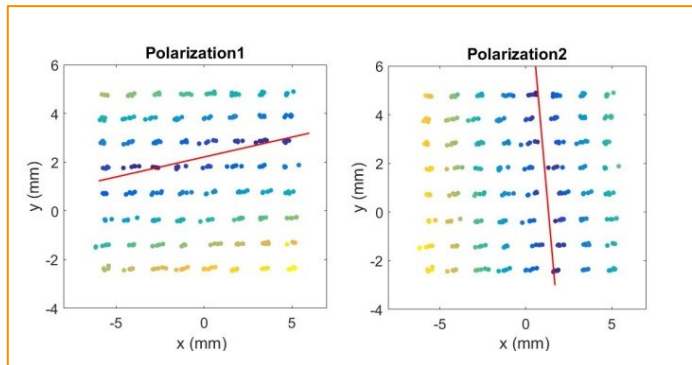

HOMBPM with Signal Fitting Method

HOMBPM calibration on April. 4th, 2018, in ACC5-CAV4.

RMS: 0.10 mm in x and 0.06 mm in y.

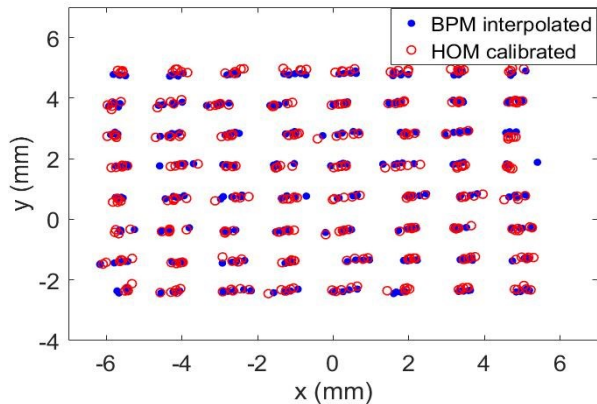

HOMBPM prediction on Jan. 23rd, 2019 in ACC5-CAV4.

RMS: 0.09 mm in x and 0.08 mm in y.

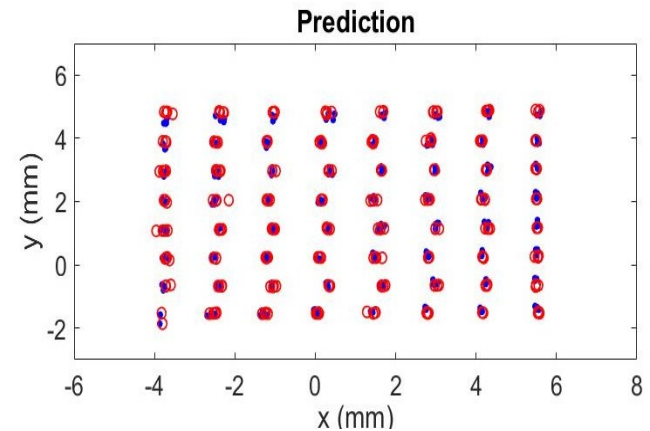

- RMS errors from four measurements.

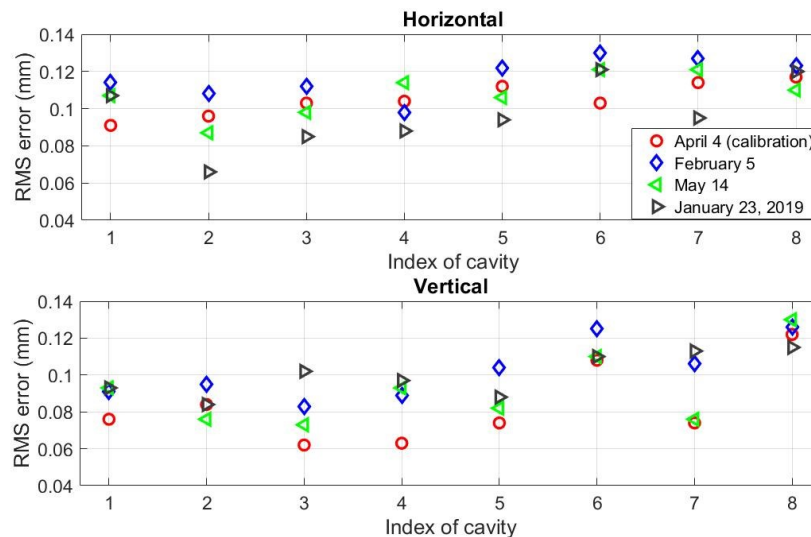

- The RMS errors from four measurements are all below 0.15 mm without significant changes over almost one year.

HOMBPM Resolution

- The HOMBPM measured the beam jitter without moving beam to get the resolution in a small area (0.4×0.4 mm).

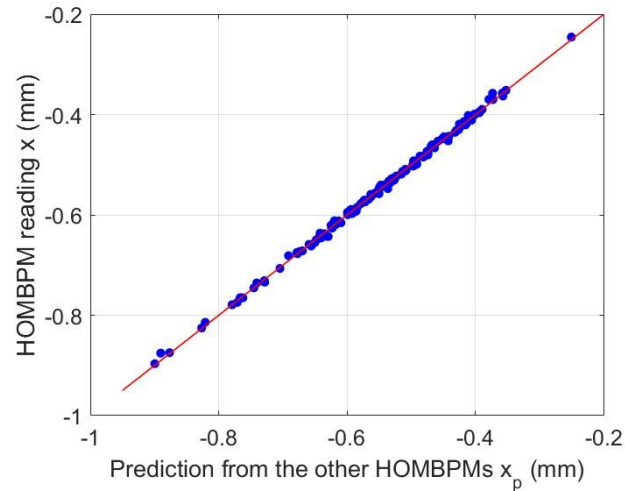

- The resolution of the HOMBPM for all eight cavities in ACC5.

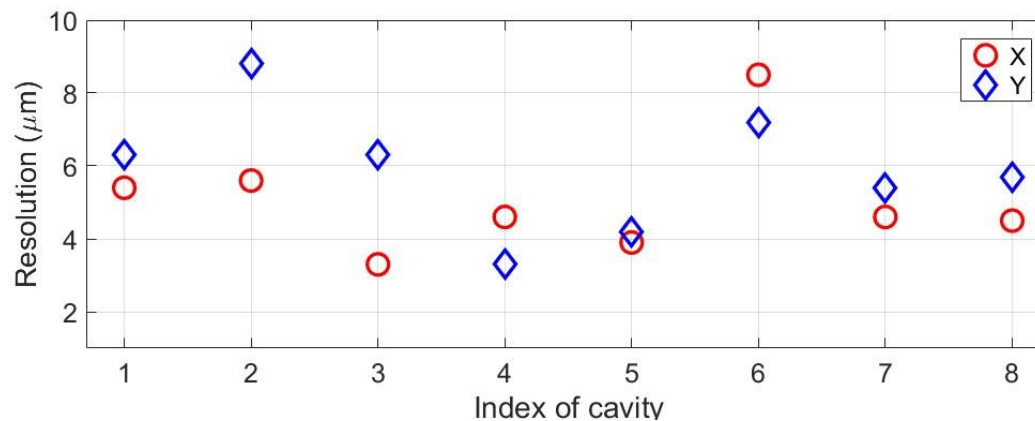

Polarization Axes and Center of the Dipole Mode

- Dipole mode polarization axes and center for all eight cavities in ACC5

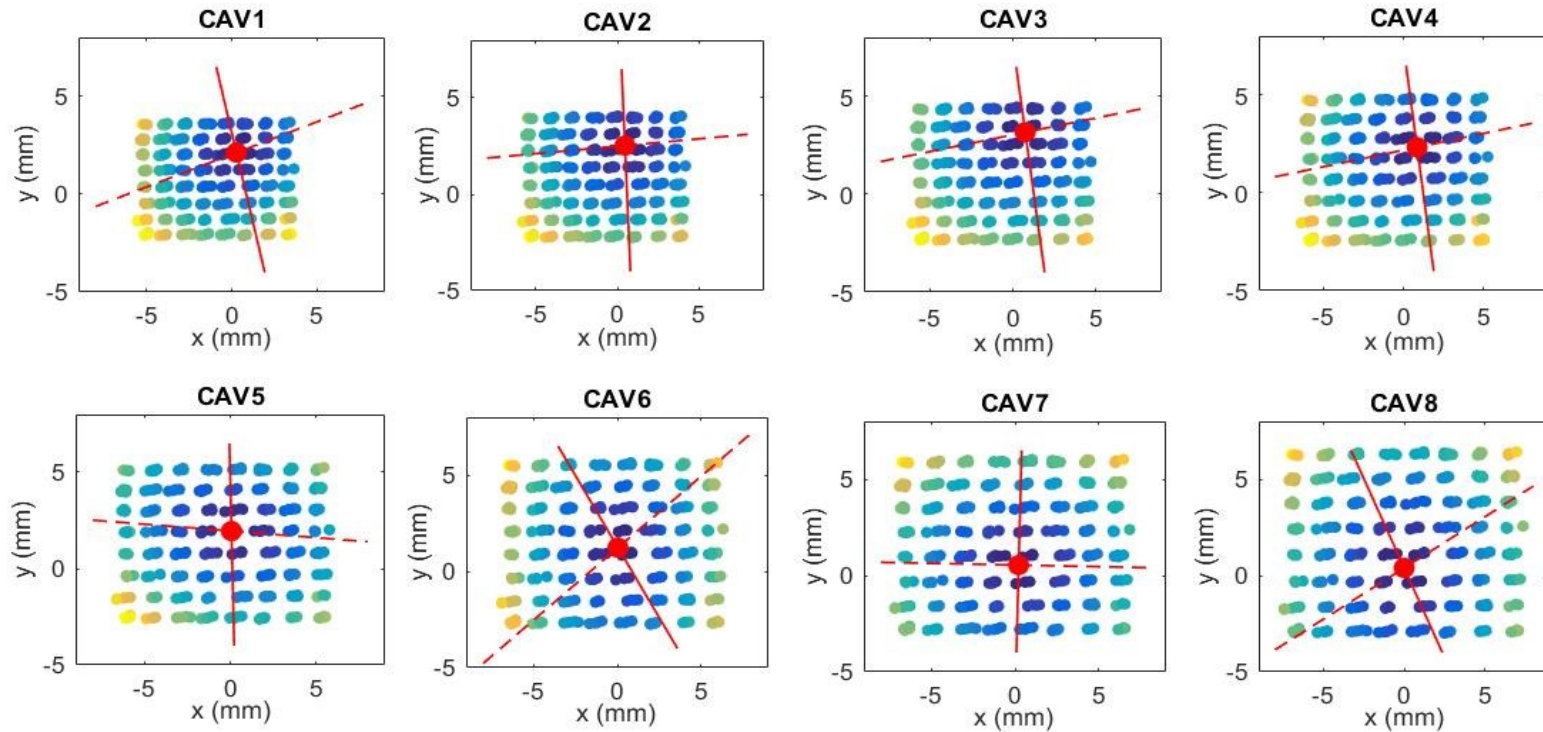

□ The two polarization axes are not orthogonal and different for different cavities.

Polarization Axes and Center of the Dipole Mode

- Rotation angles of the two polarization axes with respect to the horizontal plane.

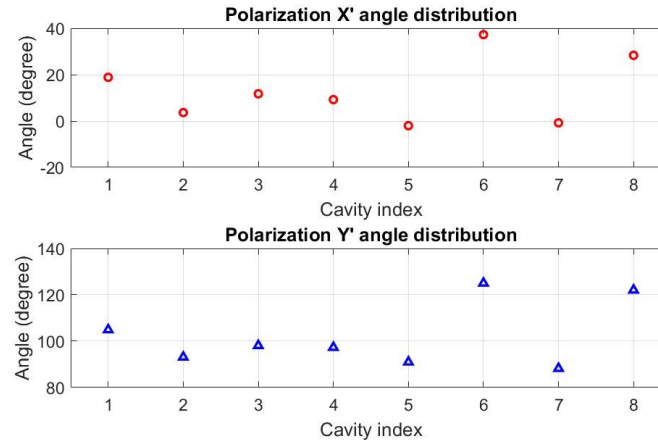

- Cavity misalignment (**Blue:** April 4 2018; **Red:** Jan. 23 2019)

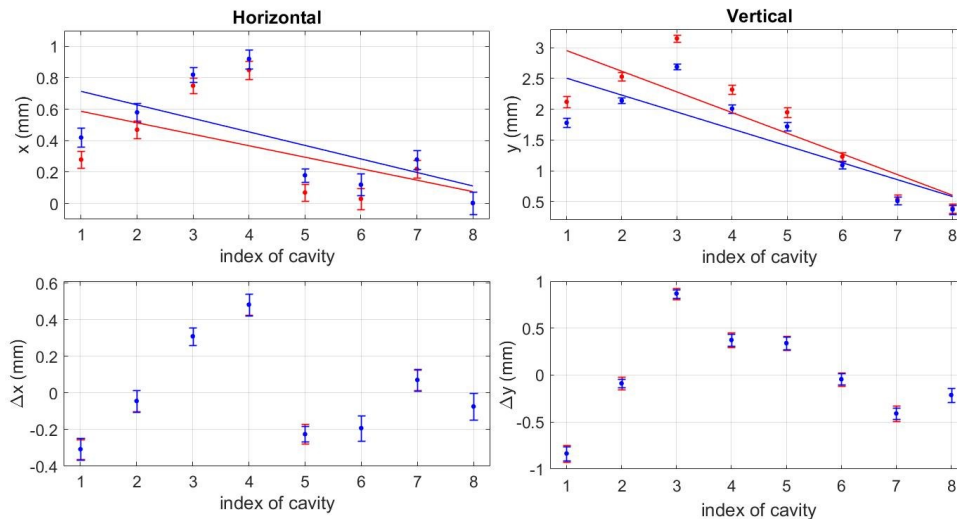

- The misalignment changed with respect to the reference axis over time, but remained the same with respect to the defined module axis between the two individual measurements.



- A brief Introduction to FLASH and Higher Order Modes
- HOM-based beam position measurement
- **Long-term HOM-based beam phase measurement**
- HOM-based cavity tilt measurement
- Summary

Beam Phase Concept

Beam Phase

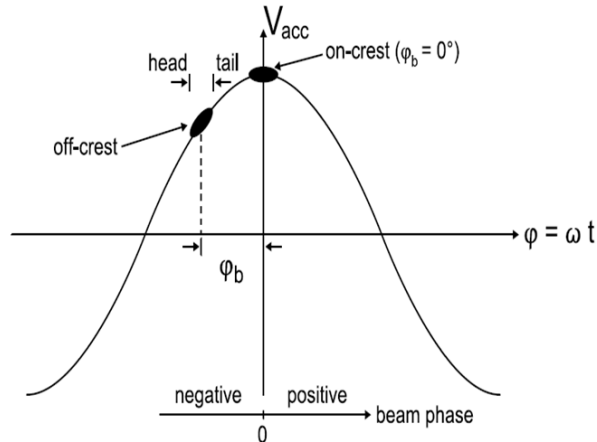

- We define the beam phase according to the time difference between these two instants: when the beam passes the cavity and when the accelerating gradient in the cavity is maximum.
- The RF field phase is defined as zero when the energy gain is max.

Vector-Sum Control

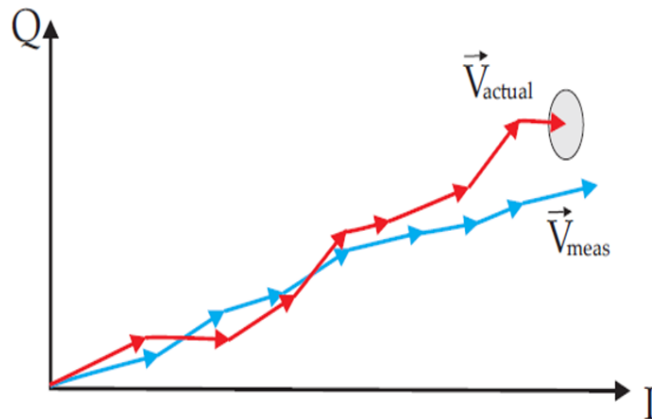

- The accelerating voltage vector of the whole ACC module is obtained by measuring the field vector of each single cavity by a probe and calculating the field vector-sum of all cavities in one or more modules.
- The disadvantage of the vector-sum is that the single cavities are not individually controlled. The actual situation in each cavity is underdetermined.

Measurement Setup

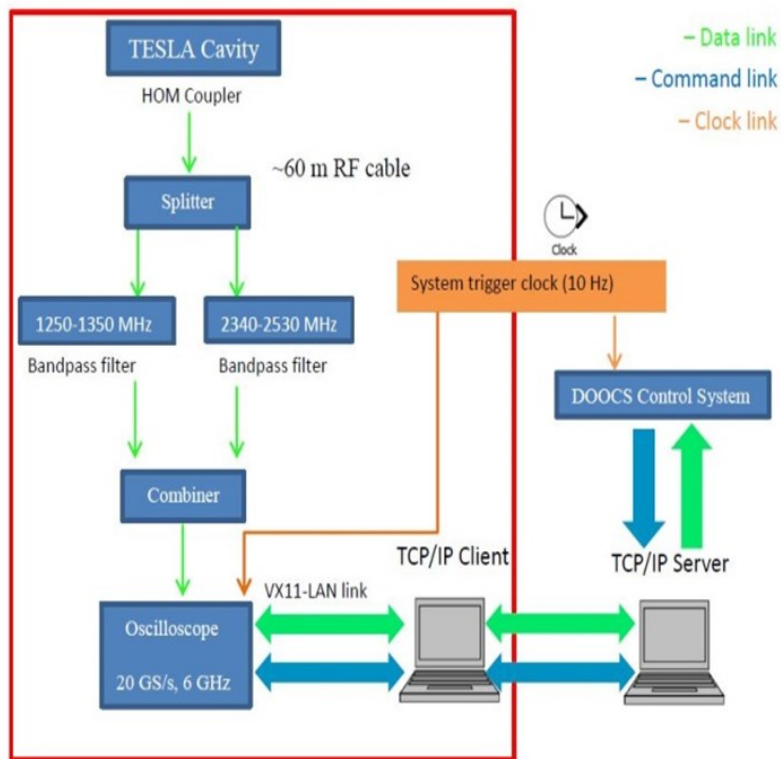

- The two HOM couplers on each cavity deliver the signal for the two channels used for beam phase measurement.
- The setup consists of two kinds of RF bandpass filters (one centered at approximately 1300 MHz with 100 MHz bandwidth and the other approximately 2435 MHz with 190 MHz bandwidth), combiner/splitter (5-2500 MHz), and a fast scope (Tektronix TDS6604B, 20 GS/s with 6 GHz bandwidth).
- One PC serves as a TCP/IP client and a second one as a server for collecting data from the control system.

Signal Processing

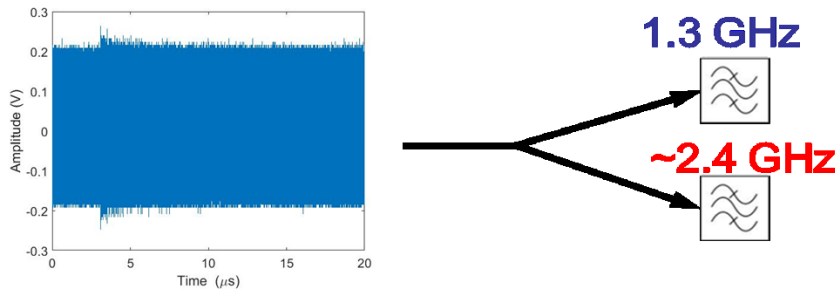
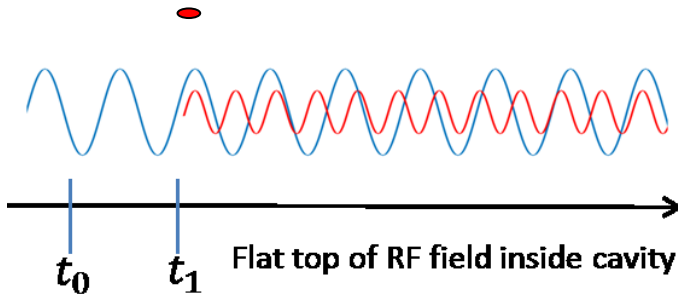

Signal waveform:

$$x(t) = a_0 + \sum_{n=1}^N (a_n \cos(\omega_n t) + b_n \sin(\omega_n t))$$

Fourier coefficients:

$$a_n = \frac{2}{T} \int_0^T x(t) \cos(\omega_n t) dt$$

$$b_n = \frac{2}{T} \int_0^T x(t) \sin(\omega_n t) dt$$

Mode amplitude and phase:

$$A_n = \sqrt{a_n^2 + b_n^2}; \varphi_n = \arctan 2(a_n, b_n)$$

Beam phase:

$$\varphi_{beam} = \varphi_0 - \omega_0 \cdot \sum_n \frac{W_n \varphi_n}{\omega_n}$$

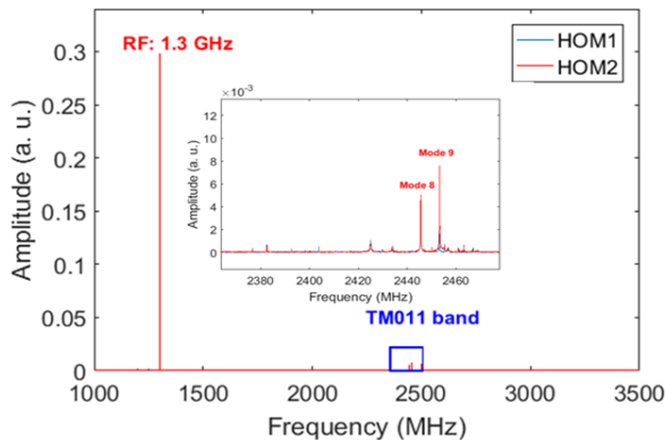

- The signal can be decomposed into a Fourier series of simple oscillating functions.
- φ_0 and ω_0 are the phase and angle frequency of the accelerating RF at 1.3 GHz, w_n is the weighting factor of mode n according to its power.

Signal Analysis

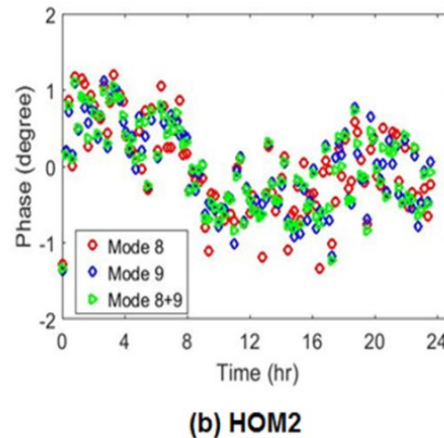
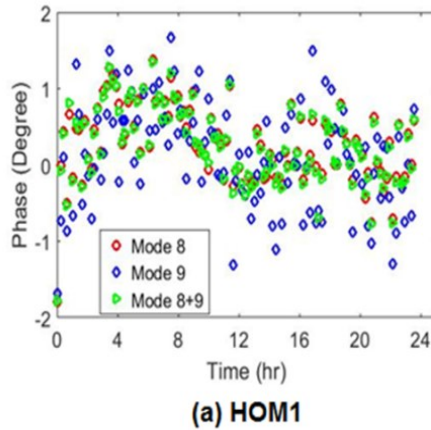

- Data was measured in one day in CAV1-ACC1. The probe phase remains basically the same.
- Beam phase measurement by using mode 8 (red), mode 9 (blue) and both modes (green) from HOM1 (a) and HOM2 (b).
- The beam phase resolution, based on the two HOM signals, is 0.30° for mode 8, 0.43° for mode 9 and 0.27° when using both.

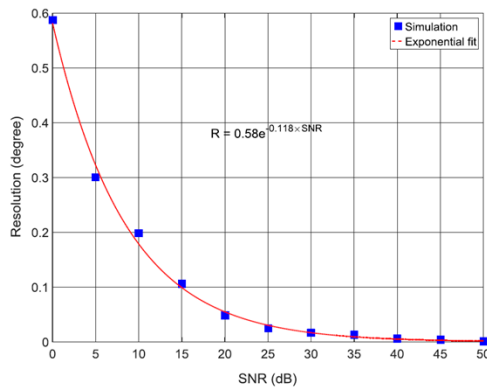

Noise

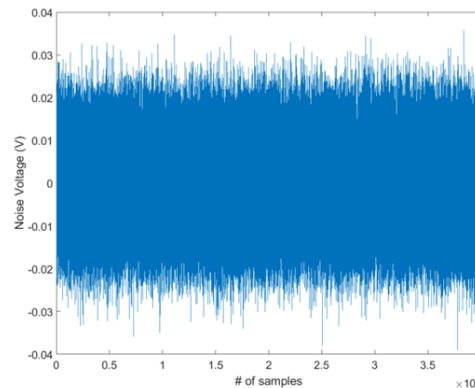

- The resolution of the HOMBPhM system is highly dependent on the noise level according to a simulation study.
- The simulation is based on a beam driven circuit model simulation.
- The noise can be estimated from the signal waveform by using SVD method (~ 10 dB).
- For 10 dB SNR, the expected resolution is 0.2°
- The measurement resolution is consistent with the simulation result.

L. Shi, **Ph. D thesis**, University of Manchester, (2017)



Long-term Beam Phase Measurement Result

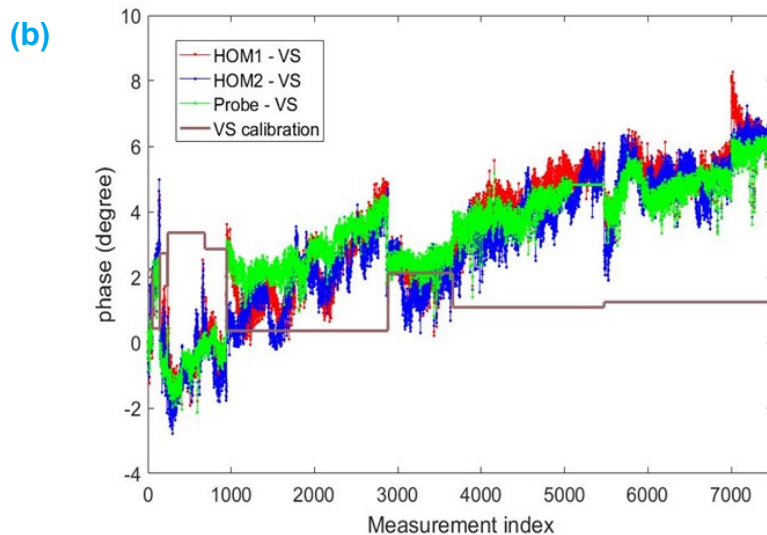
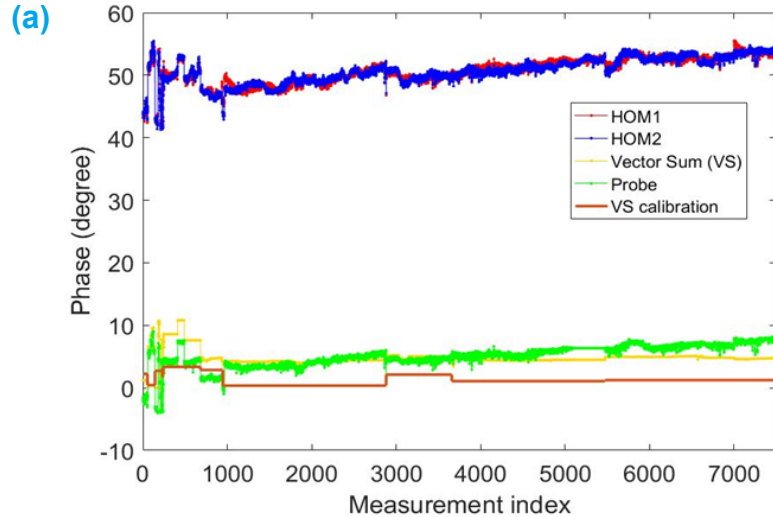

- From 1 to 21 August 2018, we measured the beam phase in cavity 1 of ACC1 at FLASH with some interruptions.
- (a) Long term phase measurement at FLASH. (b) Phase differences of the HOM phases and probe phase with respect to the VS phase.
- The HOM1 and HOM2 phases were measured in cavity 1 of ACC1 at FLASH with the HOMBPhM system. The VS phase, probe phase and VS calibration phase were recorded from the control system.
- The HOM and probe phases initially have a similar evolution as the VS phase, but they drift away over time. The HOM phase and probe phase are comparable.
- The VS calibration affects the probe phase and beam phase.
- The RMS of the phase difference between HOM1 and HOM2 is 0.41° .

J. H. Wei, *et al*, **IBIC'18**, Shanghai, China, 2018



- A brief Introduction to FLASH and Higher Order Modes
- HOM-based beam position measurement
- Long-term HOM-based beam phase measurement
- **HOM-based cavity tilt measurement**
- Summary

Dipole Mode Excitation

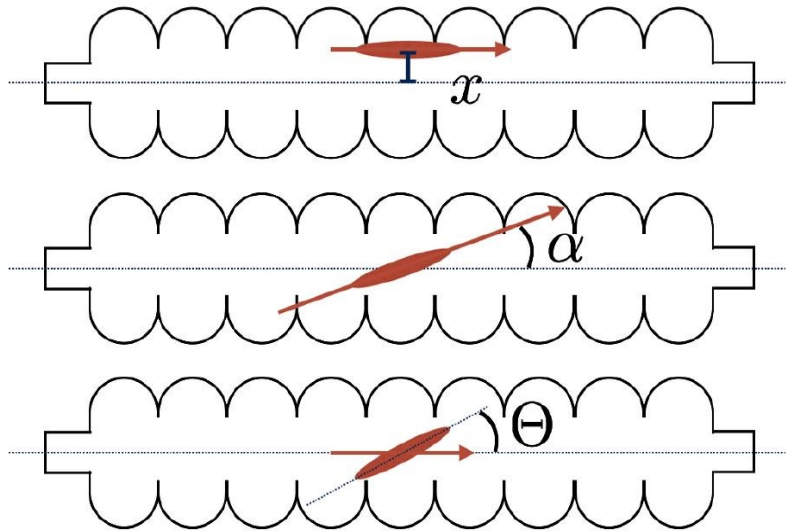

- There are three scenarios of a bunch traveling through a cavity.

(a) the bunch travels with an offset

$$V_x(t) \propto x \cdot e^{-\frac{t}{2\tau}} \sin(\omega t)$$

(b) the bunch travels with an angle with respect to cavity axis

$$V_\alpha(t) \propto \alpha \cdot e^{-\frac{t}{2\tau}} \cos(\omega t)$$

(c) the bunch is tilted

$$V_\theta(t) \approx 0 \text{ (Short bunch at FLASH)}$$

- The contribution from the beam offset and angle to the mode amplitude can be written as:

$$V_{\text{dipole}} = \sqrt{(a(x - x_0))^2 + (b(x' - x'_0))^2}$$

Measurement Setup

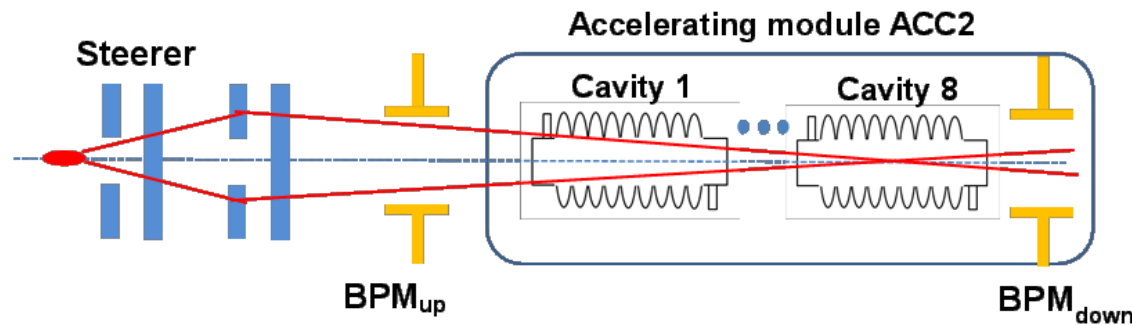

- Two pairs of steering magnets are used to move the beam in the 4D (x, x', y, y') space. The rf is switched off and the quadrupole magnets are cycled to 0. A straight beam trajectory between the two BPMs is guaranteed. The beam positions and trajectory angles are calculated from the two BPM readings.
- **Random scan method:** Make dense scans to fill the 4D (x, x', y, y') space. It takes too much time to move the beam, while most of the data does not show a clear angular dependence between dipole mode amplitude and the trajectory tilt.
- **Linear scan method:** By setting a ratio between the two steerers, we can make the beam trajectory pass through the cavity center with different angles to fill the (x, x') or (y, y') space. Due to the beam jitter and the steerer current jitter and the BPM error, it seems to be impossible to make the beam trajectory pass through exactly the cavity center.

Beam Offset Calibration

- We first calibrated the contribution of the beam offset to the dipole mode amplitude based on the signal fitting method for HOMBPM and determined the two polarization axes. The 4D space (x, x', y, y') is transformed to $(\tilde{x}, \tilde{x}', \tilde{y}, \tilde{y}')$.
- The two parameters of a and x_0 are determined.

$$V_{\text{dipole}} = \sqrt{(a(x - x_0))^2 + (b(x' - x'_0))^2}$$

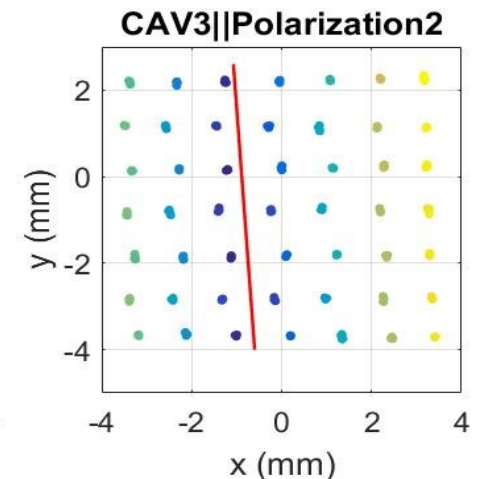
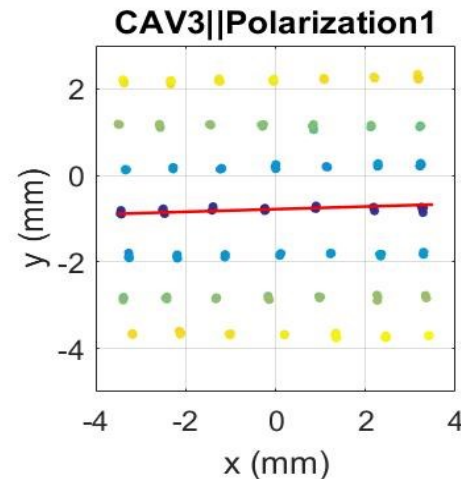
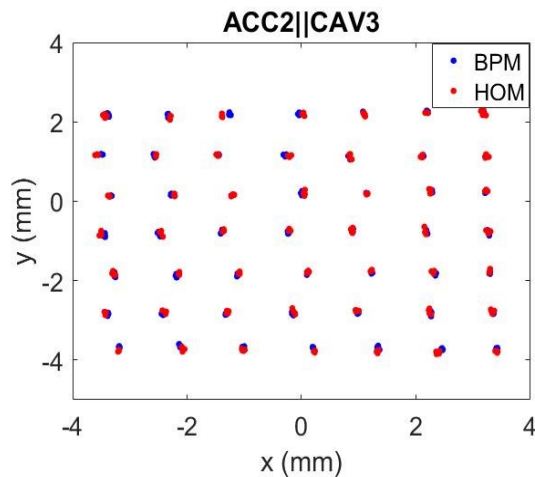

Previous Results

❖ Simulation Result

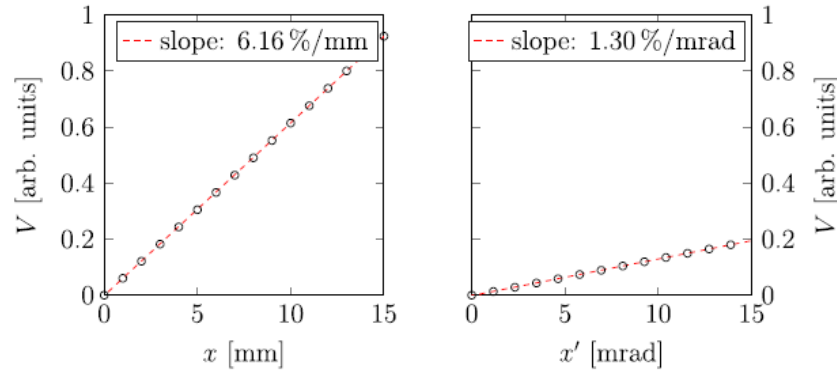

- ❑ A linear fit reveals that an amplitude excited by a tilt angle of $x'_0 = 1$ mrad corresponds to an amplitude excited by a trajectory offset of $x_0 = 0.214$ mm, which means the ratio between the offset and angle dependence of the dipole mode amplitude is 1 mrad : 0.214 mm

❖ Random Scan (ACC2-CAV2)

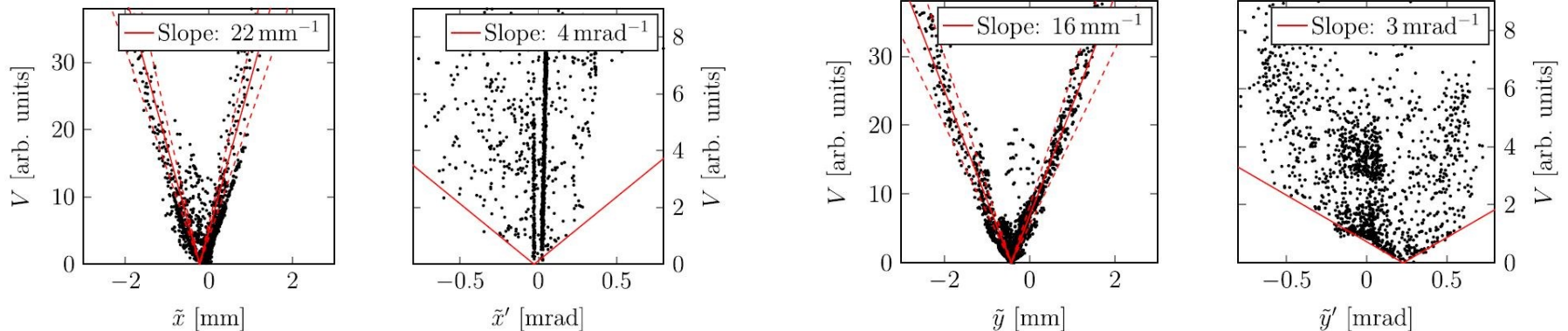

V_{mode2} in Polarization \tilde{x}

$\tilde{x}'_{\text{cav}} = -3 \mu\text{rad}$

V_{mode1} in Polarization \tilde{y}

$\tilde{y}'_{\text{cav}} = 216 \mu\text{rad}$

The ratio between the offset and angle dependence of the dipole mode amplitude is about 1 mrad : 0.2 mm.



Linear Scan Result

- Linear scan in the horizontal plane in cavity three.

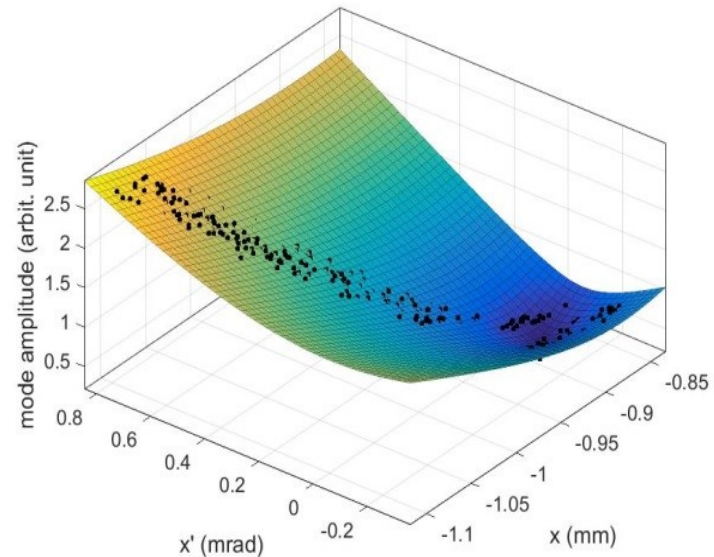
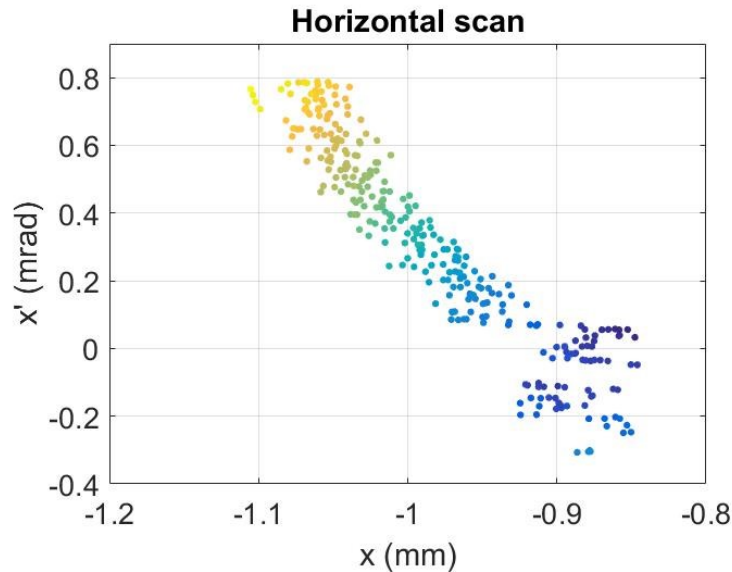

- Fitting equation: $V_{\text{dipole}} = \sqrt{(a(x - x_0))^2 + (b(x' - x'_0))^2}$
- Fitting result: $V_{\text{dipole}} = \sqrt{(6.5 \times (x + 0.88))^2 + (2.2 \times (x' + 0.056))^2}$
- The cavity tilt in x polarization is $\tilde{x}' = -0.056 \pm 0.11$ (mrad). The R-square is 0.99.
The ratio between tilt and offset dependence of the dipole mode is 1 mrad : 0.34 mm

Results in ACC2

- Ratio between tilt and offset dependence of the dipole mode.

Cavity	$\tilde{x}' : \tilde{x}$ (mrad : mm)	$\tilde{y}' : \tilde{y}$ (mrad : mm)
#1	1 : 0.24	1 : 0.26
#2	1 : 0.29	1 : 0.31
#3	1 : 0.34	1 : 0.35
#4	1 : 0.31	1 : 0.26
#6	1 : 0.31	1 : 0.28
#7	1 : 0.34	1 : 0.33
#8	1 : 0.30	1 : 0.29

- Cavity tilt in the two polarization planes.

Cavity	\tilde{x}' (mrad)	\tilde{y}' (mrad)
#1	0.31	0.213
#2	-0.06	0.131
#3	-0.056	0.190
#4	-0.253	-0.223
#6	0.082	0.654
#7	0.118	0.194
#8	0.514	0.067



- A brief Introduction to FLASH and Higher Order Modes
- HOM-based beam position measurement
- Long-term HOM-based beam phase measurement
- HOM-based cavity tilt measurement
- **Summary**

Summary

❖ HOMBPM

- The existing HOMBPM system can deliver transverse beam position information, like a cavity BPM.
- The SVD method loses its ability for predicting the beam position due to **phase drift**.
- With a new method based on signal fitting, the TESLA cavities can be **reliably** used as HOMBPMs, delivering consistent results **over several months**, with a resolution better than **10 μm** RMS.
- The dipole mode **polarization axes and center** in each cavity are also obtained.
- The signal fitting method has to be implemented into the control system.

❖ HOMBPhM

- The beam phase was measured **over a long time with respect to the RF phase**.
- The HOM phase and the probe phase have the **same trend** over a long time. Also, some **phase drifts are observed**.
- New electronics are under development by MSK for both beam phase & position measurement.

❖ Cavity Tilt Measurement

- We applied a new procedure for cavity tilt measurement (**Linear scan**).
- The **cavity tilt** has been measured in the planes of the two polarization axes for **seven cavities** in a cryomodule (**ACC2**).
- The measurements for all cavities show a consistent result that an amplitude excited by a tilt angle of **$\tilde{x}' = 1 \text{ mrad}$** corresponds to an amplitude excited by a trajectory offset of around **$\tilde{x} = 0.3 \text{ mm}$** .



Thank you for your attention !

