

DESY - Darmstadt meeting,
June 13th, 2019, Darmstadt, Germany

HOM based cavity tilt measurement in TESLA cavities at FLASH

Presenter: Junhao Wei (NSRL/USTC, DESY)

Co-authors : Nicoleta Baboi (DESY), Thorsten Hellert (LBNL)



- A brief Introduction to FLASH and Higher Order Modes
- Principle of cavity tilt measurement
- Beam offset calibration & Polarization axes
- Cavity tilt measurement results
- Summary

FLASH

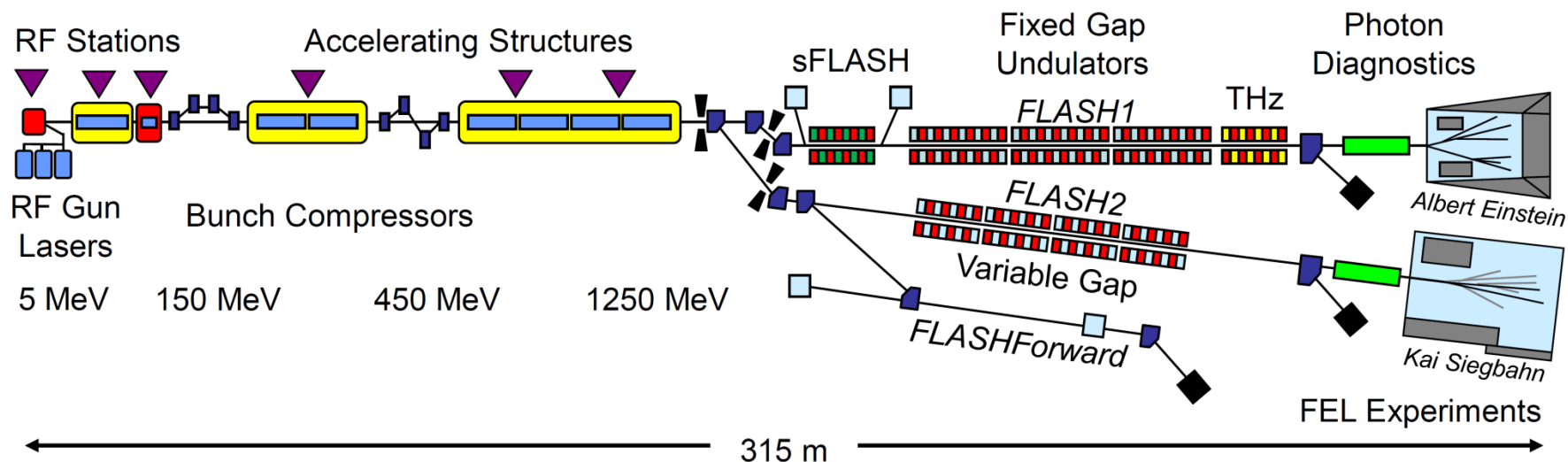

Table 1: FLASH Parameters 2016/2017

electrons :	FLASH1	FLASH2		photons :	FLASH1	FLASH2	
beam energy	350 - 1250	400 - 1250	MeV	λ (fund.)	4.2 - 51	4 - 90	nm
charge	0.1 - 1.2	0.02 - 1	nC	pulse energy (\star)	1 - 500	1 - 1000	J
emittance (\times)		1.4	μm	pulse duration (fwhm)	<30 - 200	< 10 ^(*) - 200	fs
peak current (\dagger)		0.8 - 2.5	kA	spectral width (fwhm)	0.7 - 2.0	0.5 - 2.0	%
energy spread (\circ)	0.2	0.5	MeV	peak power		1 - 5	GW
bunches / train (\ast)		1 - 500		peak brilliance		10 ²⁸ - 10 ³¹	(+)
bunch spacing		1 - 25	μs	photons /pulse		10 ¹¹ - 10 ¹⁴	
train rep. freq.		10	Hz				

(\times) : gun, $\beta\gamma\epsilon_{x,y}$, 1 nC, on-crest, 90% rms

(\dagger) : after compression (\circ) : entrance undulator

(\ast) : up to 600 (FLASH1 xor 2) possible in 2017

(\star) : average, single pulse (\ast) : estimated

(+) : photons/(s mm² mrad² 0.1%bw)



Introduction to wakefields

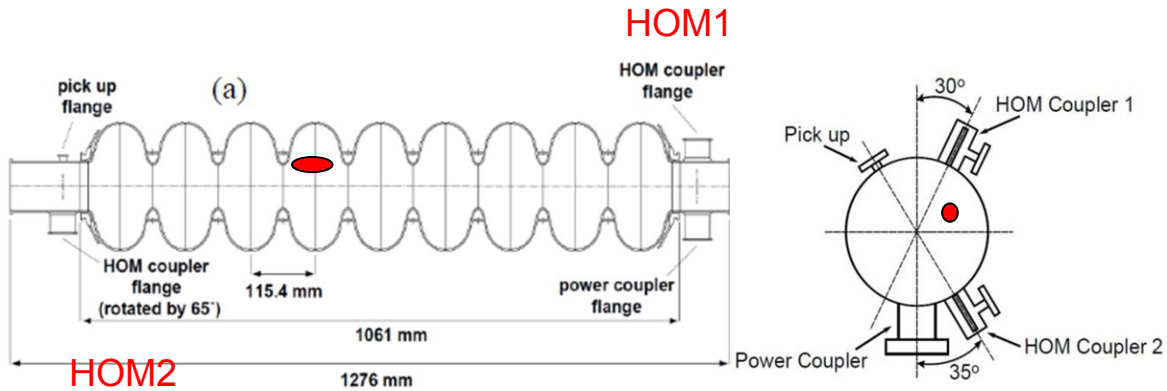

- When beam passes through a cavity, wakefields are excited. These fields are classified into monopole, dipole, quadrupole modes etc.

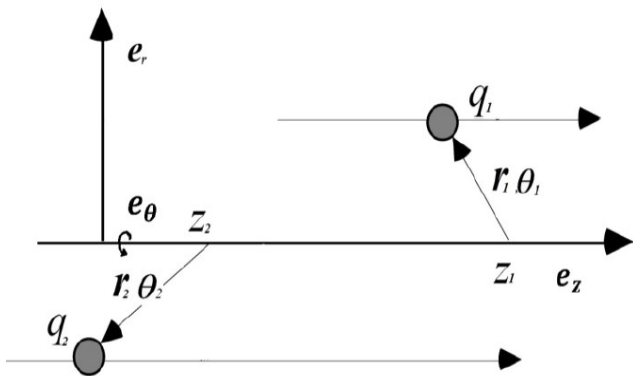

- Monopole modes dominate the longitudinal wakefield:

$$W_{\parallel} \cong - \sum_n \omega_n \left(\frac{R}{Q}\right)^n \cos\left(\frac{\omega_n s}{c}\right) H(s) \cdot e_z$$

- Dipole modes dominate the transverse wakefield:

$$W_{\perp} \cong (x e_x + y e_y) c \sum_n \left(\frac{R}{Q}\right)^n \sin\left(\frac{\omega_n s}{c}\right) H(s)$$

HOM spectrum

TESLA Cavity (1.3 GHz)

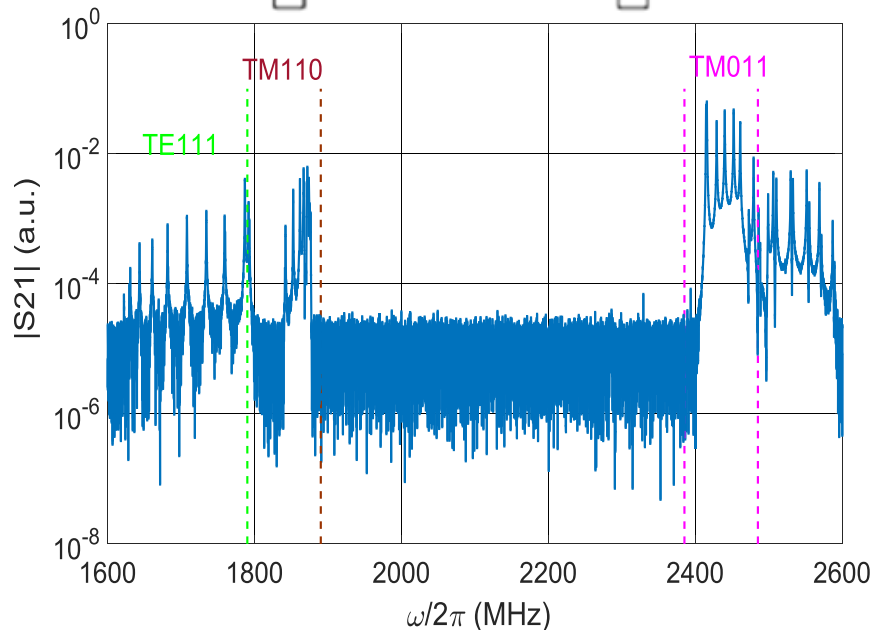
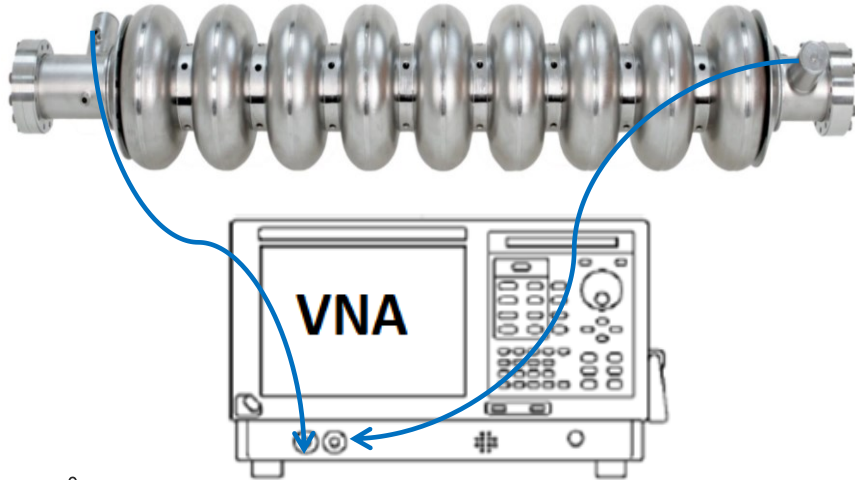

■ Monopole bands

- 2.38 to 2.45 GHz (TM011)
 - Some modes with $R/Q \sim 75$ Ohms
 - Used for phase measurements

■ Dipole Bands

- 1.63-1.8 GHz (TE111)
 - TE111-6, at 1.7GHz has strong coupling to beam
 - Used for beam position measurements
 - Two peaks indicate two polarizations in cavity
- 1.83-1.9 GHz (TE111)
 - Some modes have strong coupling to beam
 - The band is more compact

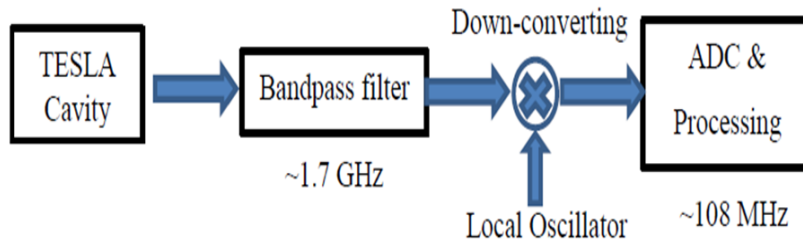

- The data acquisition system filters the HOM signal at 1.7 GHz with a 20 MHz narrow bandpass and down-mixes to 20 MHz IF (intermediate frequency), which is then sampled at about 108 MHz by the ADC.
- The two peaks in the spectrum correspond to the two polarizations of the dipole mode.

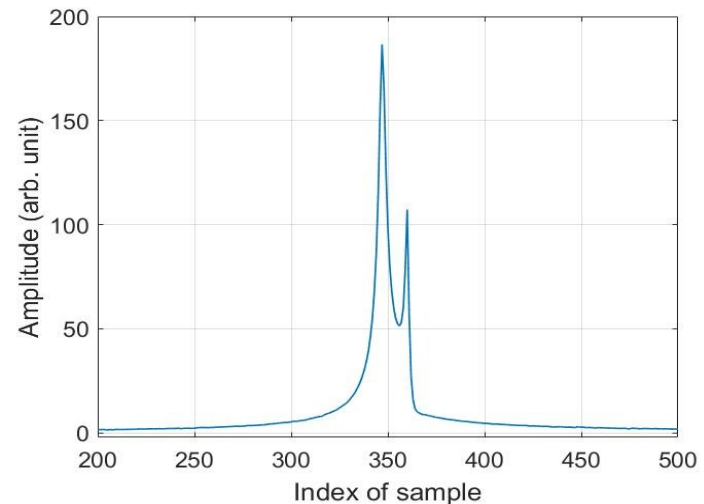
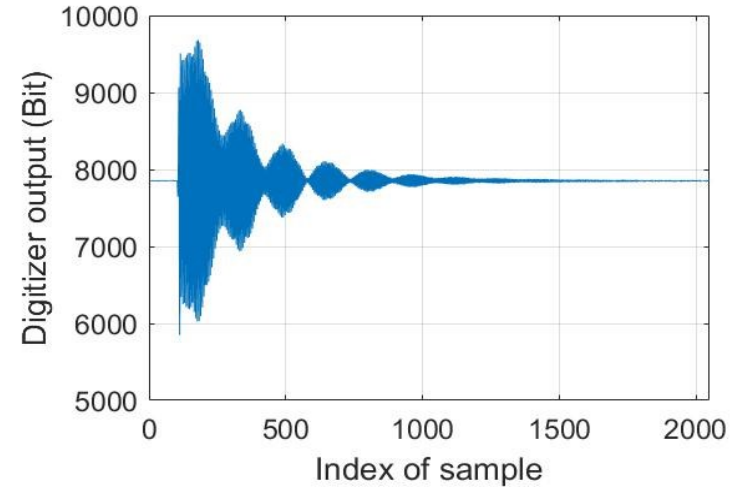

- A brief Introduction to FLASH and Higher Order Modes
- **Principle of cavity tilt measurement**
- Beam offset calibration & Polarization axes
- Cavity tilt measurement results
- Summary

Dipole mode excitation

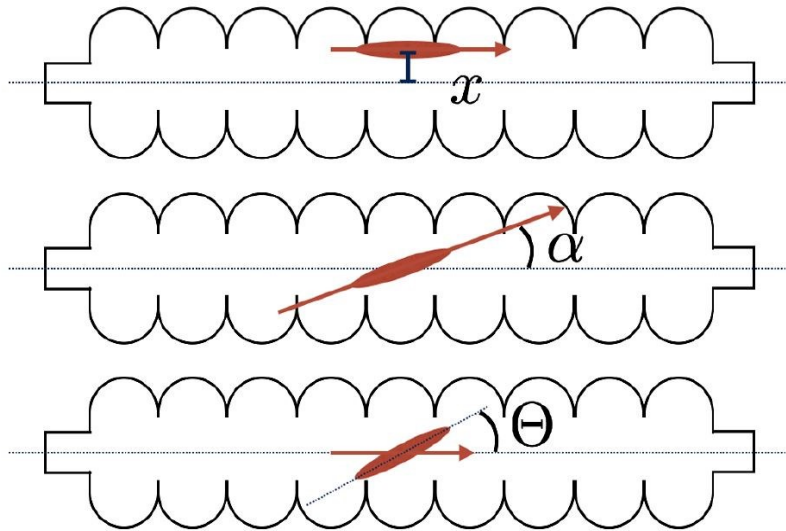

- There are three scenarios of a bunch traveling through a cavity.
 - (a) the bunch travels with an offset,
 - (b) the bunch travels with an angle with respect to cavity axis,
 - (c) the bunch is tilted.
$$V_x(t) \propto x \cdot e^{-\frac{t}{2\tau}} \sin(\omega t)$$
$$V_\alpha(t) \propto \alpha \cdot e^{-\frac{t}{2\tau}} \cos(\omega t)$$
$$V_\Theta(t) \approx 0 \quad (\text{ultra short pulse at FLASH})$$

- The contribution from the beam offset and tilt to the mode amplitude can be written as:

$$V_{\text{dipole}} = \sqrt{(a(x - x_0))^2 + (b(x' - x'_0))^2}$$

Simulation

- The electric and magnetic field in a cavity can be expanded in terms of orthogonal eigen functions $\mathbf{e}^{(m)}$ and $\mathbf{h}^{(m)}$, with the time-dependent eigenmode amplitudes $q^{(m)}$ and $p^{(m)}$ of mode m . :

$$\mathbf{E}(x, y, z, t) = \text{Re} \left\{ \sum_m q^{(m)}(t) \cdot \mathbf{e}^{(m)}(x, y, z) \right\},$$

$$\mathbf{H}(x, y, z, t) = \text{Re} \left\{ \sum_m p^{(m)}(t) \cdot \mathbf{h}^{(m)}(x, y, z) \right\}$$

- By inserting these equations into the Maxwell equations in a vacuum, the second-order differential equation for the amplitude of the electric field can be obtained as

$$\frac{d^2}{dt^2} q^{(m)}(t) + \omega_m^2 q^{(m)}(t) = -\frac{Qc}{\varepsilon_0} \frac{d}{dt} [\mathbf{e}^{(m)}(\mathbf{x}(t)) \cdot \hat{\mathbf{x}}(t)]$$

- The field distribution of TE111-6 is obtained via CST, and the problem is solved numerically:

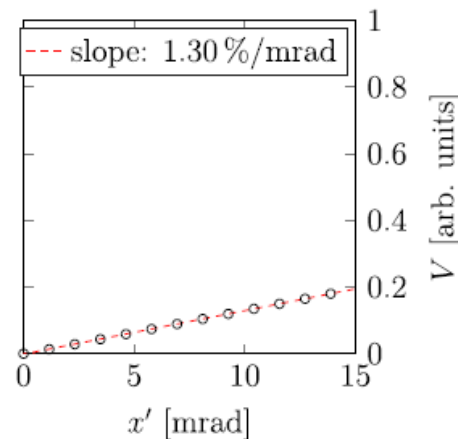
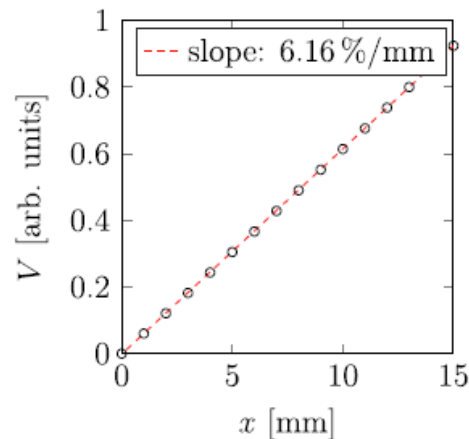

- A linear fit reveals that an amplitude excited by a tilt angle of $x'_0 = 1$ mrad corresponds to an amplitude excited by a trajectory offset of $x_0 = 214 \mu\text{m}$.



Signal fitting

- The dipole mode signal mainly consists of two polarizations corresponding to the two signal peaks in the frequency domain. Signal fitting can give the latent information, such as the phase, independent amplitude and decay constant of each polarization.

$$A = a_0 + a_1 \sin(\omega_1 t + \varphi_1) e^{-\frac{t}{\tau_1}} + a_2 \sin(\omega_2 t + \varphi_2) e^{-\frac{t}{\tau_2}}$$

- The original waveform (blue) and the fitted waveform (red) from cavity three. These two waveforms are basically coincident. The STD of the signal difference is 0.009 kBits while the coefficient of determination (r^2) is over 0.999.

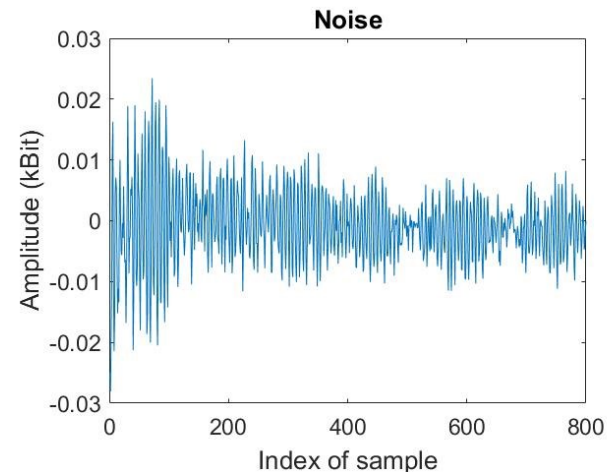
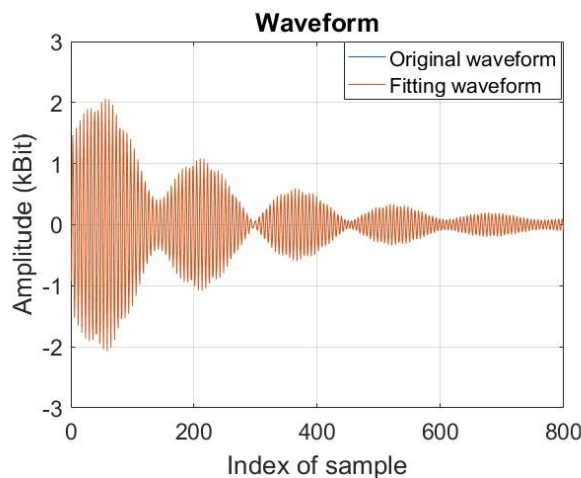

- If these two polarizations are degenerated, the signal fitting method cannot separate the amplitudes of the two polarizations.

- A brief Introduction to FLASH and Higher Order Modes
- Principle of cavity tilt measurement
- **Beam offset calibration & Polarization axes**
- Cavity tilt measurement results
- Summary

Beam offset calibration

- Two steering magnets are used to move the beam. The rf is switched off and the quadrupole magnets are cycled to 0. A straight beam trajectory between the two BPMs is guaranteed.
- The beam is steered over a range of approximately 10 mm by 10 mm in x and y in the downstream BPM. The trajectory tilt is in the range of 0.5 mrad. Compared to the beam offset, the dipole mode amplitude excited by the tilt is very small and can be ignored.

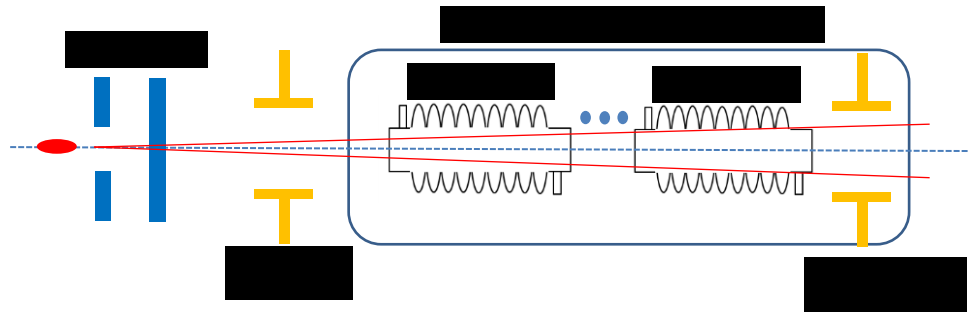

- We correlate the two polarization amplitudes to the beam positions interpolated from two BPMs by linear regression. The RMS error between the HOM calibrated and the BPM interpolated beam positions is about 0.05 mm in x and 0.06 mm in y .

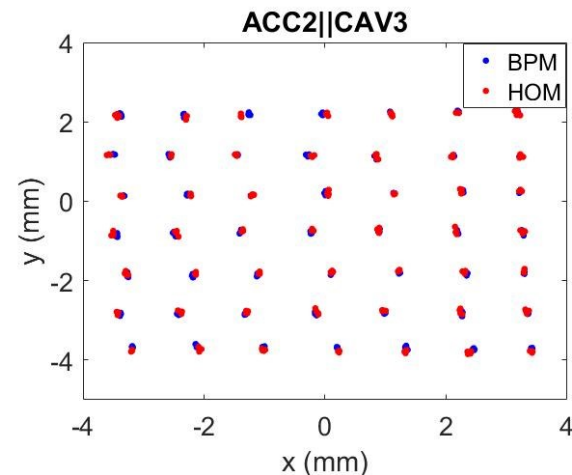

Polarization axes

- Each dipole mode exists in two polarizations. Due to field disturbances caused by structure imperfections and couplers, the geometrical axis of the cavity can deviate slightly from the electrical axis of the considered dipole mode.
- Normalized amplitude of Polarization1 (left) and Polarization2 (right) in cavity three in ACC2 as a function of beam offset x and y . The red lines indicate the fitted polarization axes for both modes. The rotation angles of the two polarization axes with respect to the horizontal plane are 1.7° and 94.1° respectively.

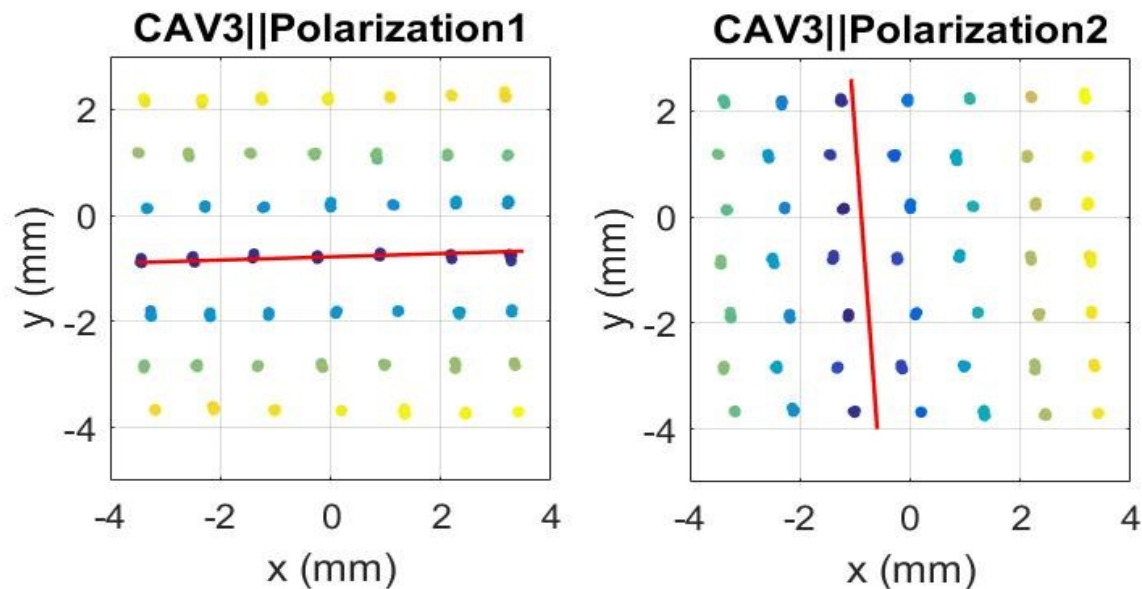

- A brief Introduction to FLASH and Higher Order Modes
- Principle of cavity tilt measurement
- Beam offset calibration & Polarization axes
- **Cavity tilt measurement results**
- Summary

Measurement setup

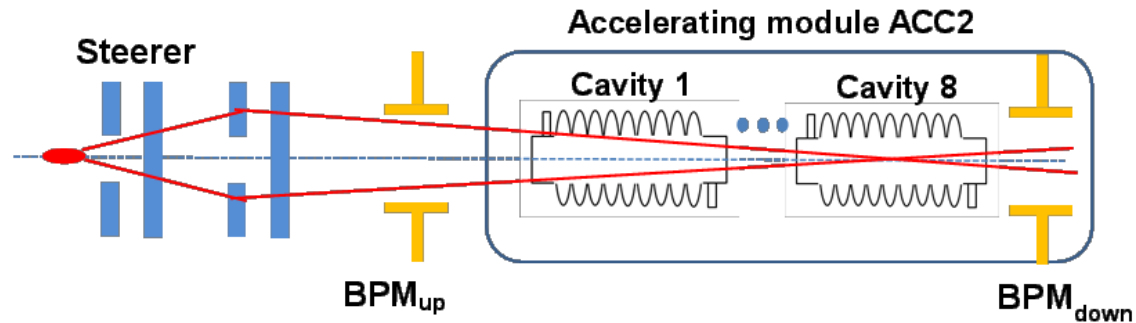

- Two pairs of steering magnets are used to move the beam in 4D (x, x', y, y') space. The rf is switched off and the quadrupole magnets are cycled to 0. A straight beam trajectory between the two BPMs is guaranteed. The beam positions and trajectory angles are calculated from the two BPM readings.
- **Random scan:** Make dense scans to fill the 4D (x, x', y, y') space. It takes too much time to move the beam, while most of the data does not show a clear angular dependence between dipole mode amplitude and the trajectory tilt.
- **Linear scan:** By setting a ratio between the two steers, we can make the beam trajectory pass through the cavity center with different angles to fill the (x, x') or (y, y') space. Due to the beam jitter and the steerer current jitter, it seems to be impossible to make the beam trajectory pass through exactly the cavity center.

Random scan result

- Random Scan in cavity two

Thorsten Hellert, *et al*, *Phys.Rev.Accel.Beams* 20 (2017), 123501.

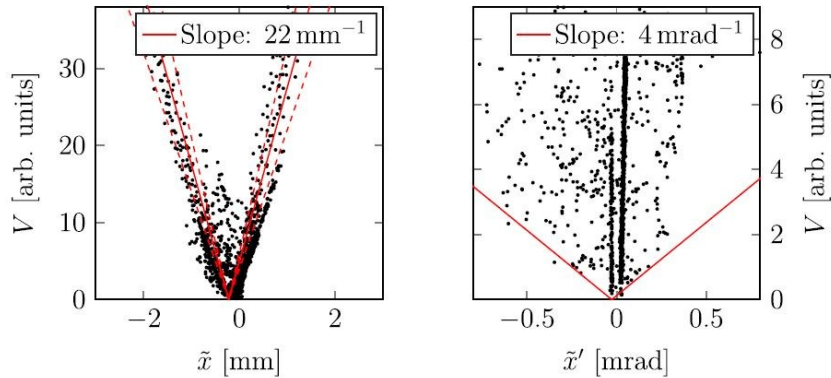

Polarization2 in \tilde{x} $\tilde{x}'_{cav} = -3 \mu\text{rad}$

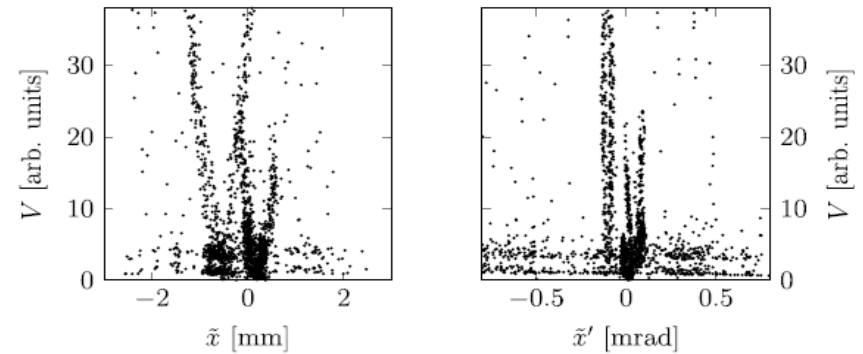

Polarization1 in Polarization \tilde{x}

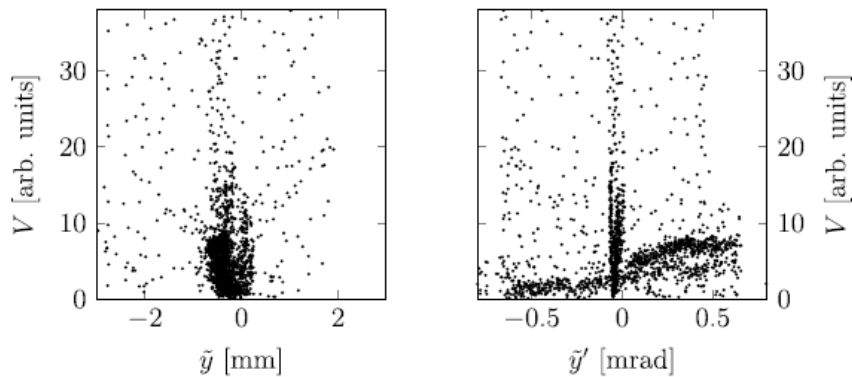

Polarization2 in \tilde{y}

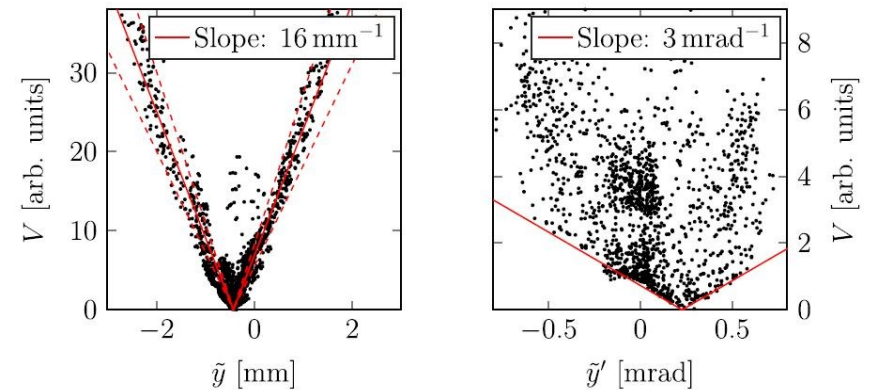

Polarization1 in \tilde{y} $\tilde{y}'_{cav} = 216 \mu\text{rad}$

Linear scan result (1)

- Linear scan in the horizontal plane in cavity three.

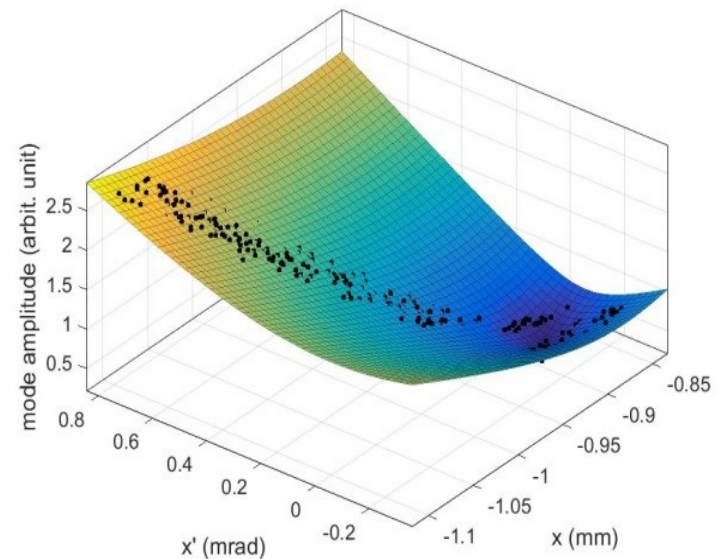
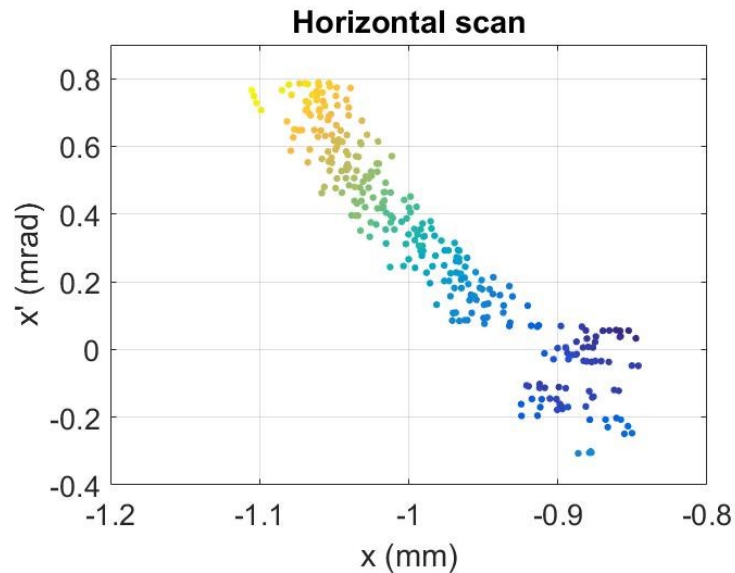

- Fitting equation: $f(x,y) = \sqrt{((6.5*(x+0.88))^2 + ((2.2*(y+0.056))^2)}$
- The cavity tilt in x polarization is $\tilde{x}' = -0.056 \pm 0.11$ (mrad). The R-square is 0.99. The ratio between tilt and offset dependence of the dipole mode is 1 mrad : 0.34 mm

Linear scan result (2)

- Linear scan in the vertical plane in cavity three.

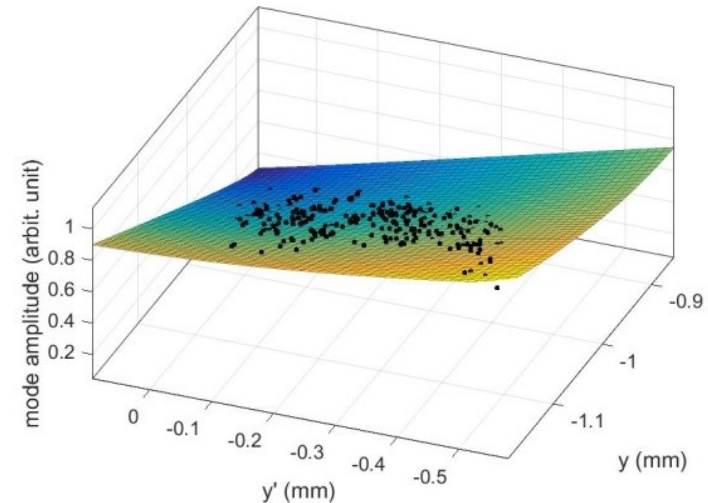
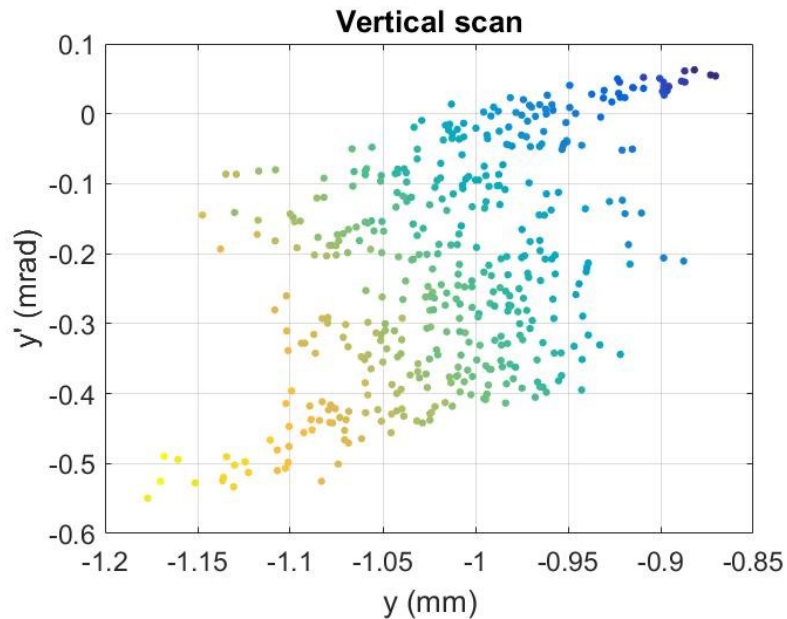

- Fitting equation: $f(x,y) = \sqrt{(2.72*(x+0.84))^2 + ((0.97*(y-0.19))^2)}$
- The cavity tilt in y polarization is $\tilde{y}' = 0.190 \pm 0.06$ (mrad). The R-square is 0.97. The ratio between tilt and offset dependence of the dipole mode is 1 mrad : 0.35 mm.

Results in ACC2

- Cavity tilt in two polarization planes.

Cavity	\tilde{x}' (mrad)	\tilde{y}' (mrad)
#1	-	0.213
#2	-	0.131
#3	-0.056	0.190
#4	-0.253	-0.223
#6	0.082	0.654
#7	0.118	0.194
#8	0.514	0.067

- Ratio between tilt and offset dependence of the dipole mode.

Cavity	$\tilde{x}' : \tilde{x}$ (mrad : mm)	$\tilde{y}' : \tilde{y}$ (mrad : mm)
#1	-	1 : 0.26
#2	-	1 : 0.31
#3	1 : 0.34	1 : 0.35
#4	1 : 0.31	1 : 0.26
#6	1 : 0.31	1 : 0.28
#7	1 : 0.34	1 : 0.33
#8	1 : 0.30	1 : 0.29

- A brief Introduction to FLASH and Higher Order Modes
- Principle of cavity tilt measurement
- Beam offset calibration & Polarization axes
- Cavity tilt measurement results
- **Summary**

Summary

- ❑ In addition to the beam offset, a tilt of beam trajectory can also excite dipole modes.
- ❑ Base on the signal fitting method, the amplitude of the dipole mode can be obtained.
- ❑ By making a grid scan, we calibrate the correlation between the beam offset and the dipole mode amplitude, and determine the polarization axes.
- ❑ The beam trajectory is moved by two steerers in the horizontal or vertical plane to make it pass through the cavity center with different tilt.
- ❑ The cavity tilt measurement has been made in a whole module (ACC2) at FLASH. The cavity tilt in two polarization axes has been measured in several cavities.
- ❑ An amplitude excited by a tilt angle of $\tilde{x}' = 1$ mrad corresponds to an amplitude excited by a trajectory offset of about $\tilde{x} = 0.3$ mm.



Thank you for your attention!

