

HOM Based Beam Diagnostics in TESLA Superconducting Cavities at FLASH

Presenter: **Junhao, Wei** (NSRL/USTC, DESY)
Co-authors : Nicoleta Baboi (DESY), Liangliang Shi (PSI)

Outline

- A brief Introduction to FLASH and Higher Order Modes
- HOM based beam position measurement
- HOM based long-term beam phase measurement
- HOM based cavity tilt measurement
- Summary



➤ **A brief Introduction to FLASH and Higher Order Modes**

➤ HOM based beam position measurement

➤ HOM based long-term beam phase measurement

➤ HOM based cavity tilt measurement

➤ Summary



FLASH

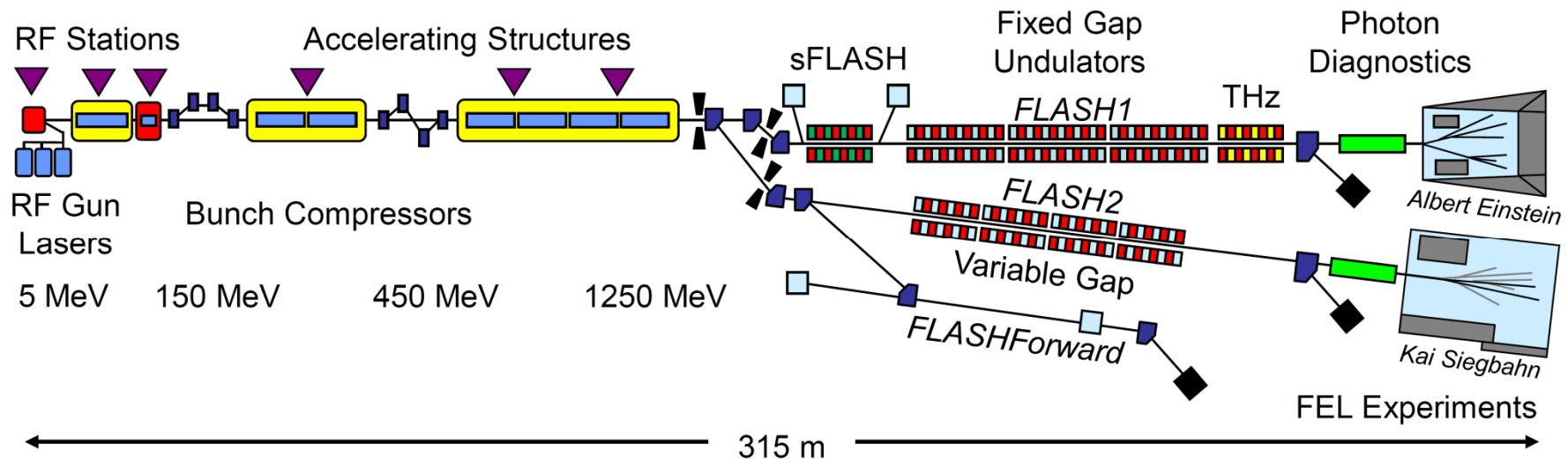

Table 1: FLASH Parameters 2016/2017

electrons :	FLASH1	FLASH2		photons :	FLASH1	FLASH2	
beam energy	350 - 1250	400 - 1250	MeV	λ (fund.)	4.2 - 51	4 - 90	nm
charge	0.1 - 1.2	0.02 - 1	nC	pulse energy (★)	1 - 500	1 - 1000	J
emittance (×)		1.4	μm	pulse duration (fwhm)	<30 - 200	< 10 ^(*) - 200	fs
peak current (†)		0.8 - 2.5	kA	spectral width (fwhm)	0.7 - 2.0	0.5 - 2.0	%
energy spread (○)	0.2	0.5	MeV	peak power		1 - 5	GW
bunches / train (*)		1 - 500		peak brilliance		10 ²⁸ - 10 ³¹	(+)
bunch spacing		1 - 25	μs	photons /pulse		10 ¹¹ - 10 ¹⁴	
train rep. freq.		10	Hz				

(×) : gun, $\beta\gamma\epsilon_{x,y}$, 1 nC, on-crest, 90% rms

(†) : after compression (○) : entrance undulator

(*) : up to 600 (FLASH1 xor 2) possible in 2017



Introduction to Wakefields and HOM

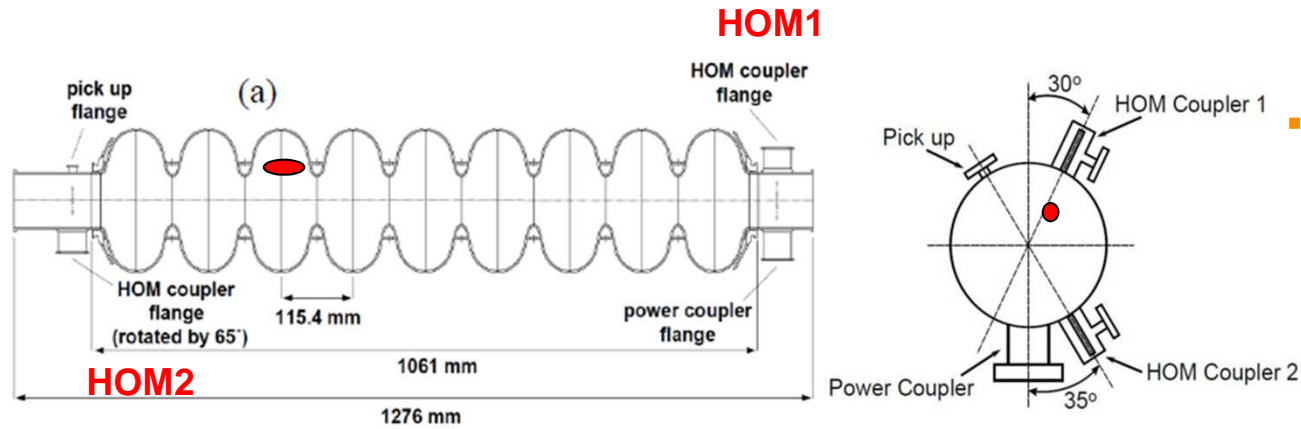

When beam passes through a cavity, wakefields are excited. These fields are classified into monopole, dipole, quadrupole modes etc.

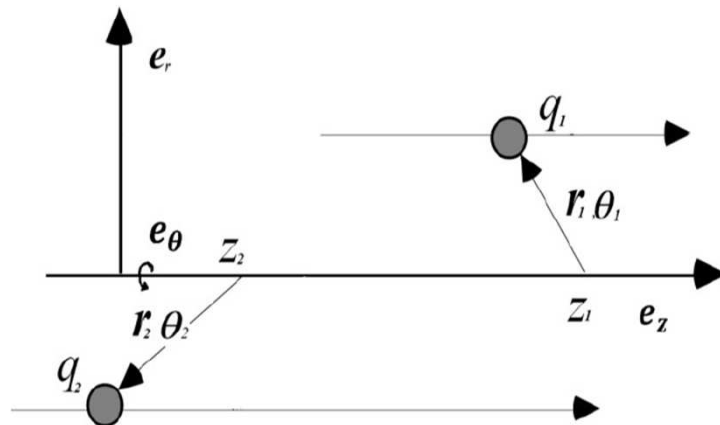

Longitudinal wake potential from monopole modes:

$$W_{\parallel} \cong - \sum_n \omega_{0n} \left(\frac{R}{Q}\right)^{(0n)} \cos\left(\frac{\omega_{0n}S}{c}\right) H(s) \mathbf{e}_z,$$

Transverse wake potential from dipole modes

$$W_{\perp} \cong r_1 c \sum_n \left(\frac{R}{Q}\right)^{(1n)} \sin\left(\frac{\omega_{1n}S}{c}\right) H(s) [\cos(\theta_1 - \theta_2) \mathbf{e}_r + \sin(\theta_1 - \theta_2) \mathbf{e}_{\theta}].$$

Mode Characteristics

❖ Modes in TESLA cavity

■ Monopole bands

- 1.28 -1.3 GHz
 - Includes accelerating mode at 1.3GHz (R/Q =511 Ohms)
 - Low R/Q for other modes
- 2.38 -2.45 GHz
 - Some modes with R/Q ~75 Ohms
 - Used for phase measurements

■ Dipole Bands

- 1.63-1.8 GHz
 - TE111-6, at 1.7GHz has strong coupling to beam (R/Q =4.11 Ohms)
 - Used for beam position measurements
 - Two peaks indicate two polarizations in each cavity

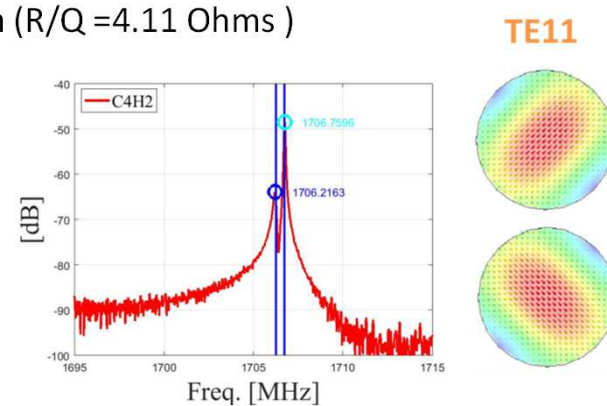
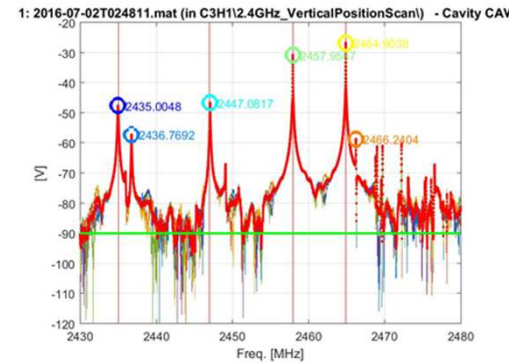
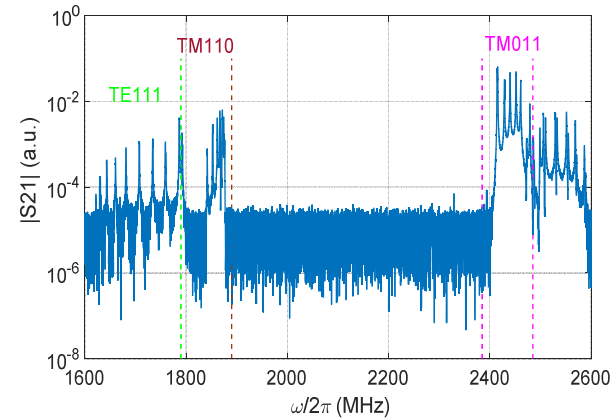

Motivations

❖ HOM carries information about the beam properties to measure the beam

- Monopole HOM mode phase determined by beam arrival time (beam phase).
- The strength of the excited dipole modes depends linearly on the beam charge and transverse position: $q \cdot r \cdot (R/Q)$.

❖ Cavity structure diagnostics

- HOM modes measure interior of structure.
- Beam measurement also relative to the cavity structure.
- Measure the cavity tilt and offset.

❖ Some benefits

- Additional beam diagnostics without additional vacuum component, therefore relatively cheap.
- Monitor the transverse beam position in cavities.
- On-line measurement of beam phase wrt RF phase.
- Cavity alignment.



- A brief Introduction to HOM based beam diagnostics
- **HOM based beam position measurement**
- HOM based long-term beam phase measurement
- HOM based cavity tilt measurement
- Summary

Measurement Setup

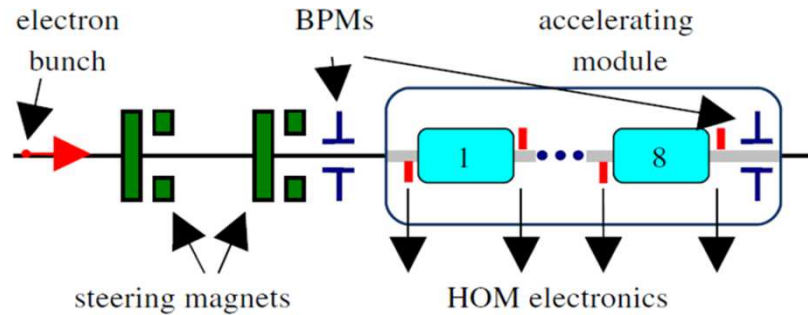

- Two pairs of steering magnets are used to move the beam. RF is switched off, the quadrupole magnets are cycled to 0. A straight beam trajectory between the two BPMs is guaranteed.
- The beam is steered over a range of approximately 10 mm x 10 mm in X and Y in module ACC5.
- Two BPMs located upstream and downstream of the module give the interpolated beam positions in the cavities.

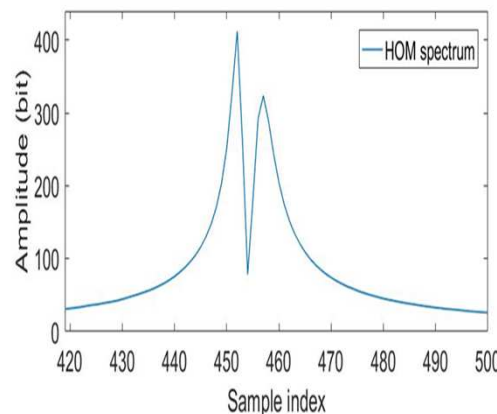
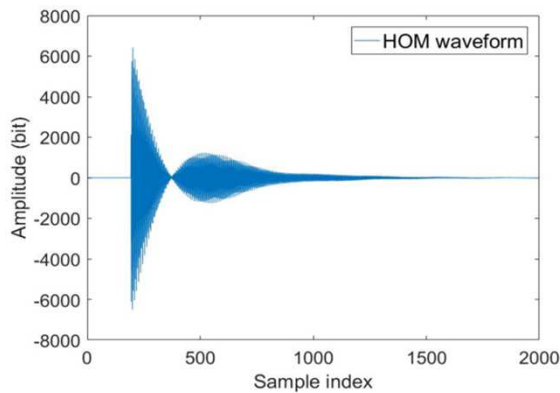
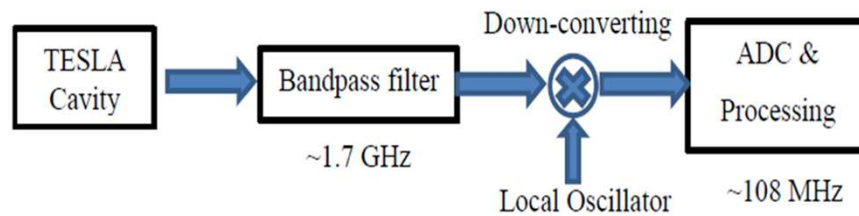

- The data acquisition system filters the HOM signal at 1.7 GHz with a 20 MHz narrow bandpass and down-mixes to 20 MHz IF (intermediate frequency), which is then sampled at about 108 MHz by the ADC.

PLS and SVD Method

- In order to extract the beam position information concealed in the dipole modes signals, we construct the measurement signals in matrix form.
- PLS (Partial Least Square) and SVD (Singular Value Decomposition) are useful methods to solve the linear regression model. They can find the latent components in the HOM data that have high correlation with the beam position to reduce the noise and matrix dimension.

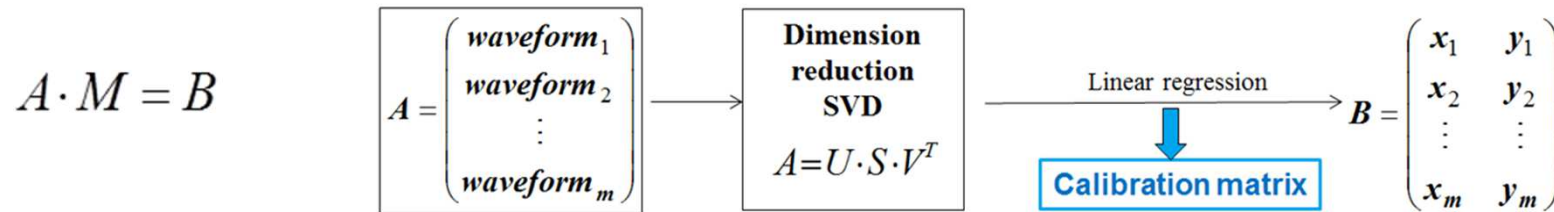

- SVD method can estimate the signal noise by using the first 5 modes to reconstruct HOM signals (noise std value: 24.3 bits).

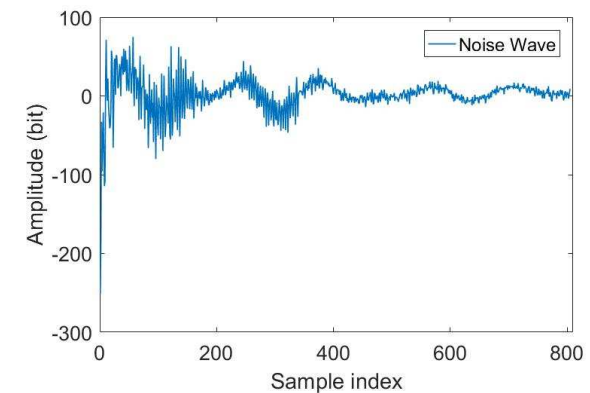
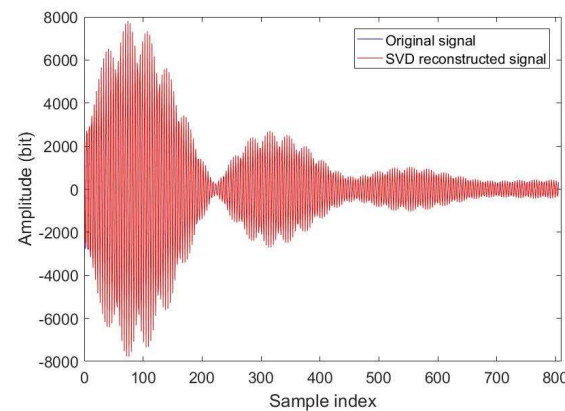
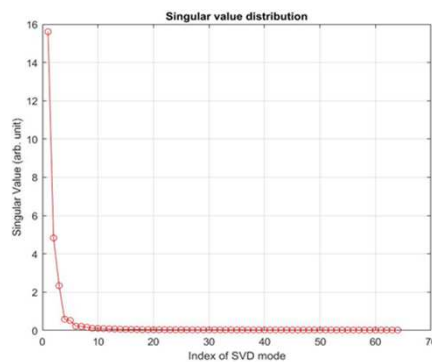

HOMBPM Calibration and Prediction using Waveform

❖ HOMBPM Calibration

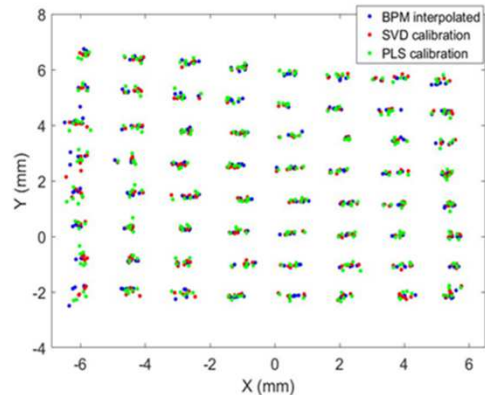

Calibrated beam positions in ACC5-CAV4

- Calibration data was measured on April 4th in module ACC5.
- Calibration samples of PLS and SVD are compared with interpolated beam positions by using the waveforms.
- The RMS errors of PLS and SVD of calibration positions from coupler 1 in cavity 4 are:

RMS	X (mm)	Y (mm)
PLS	0.116	0.127
SVD	0.118	0.132

❖ Beam Position Prediction in a short time

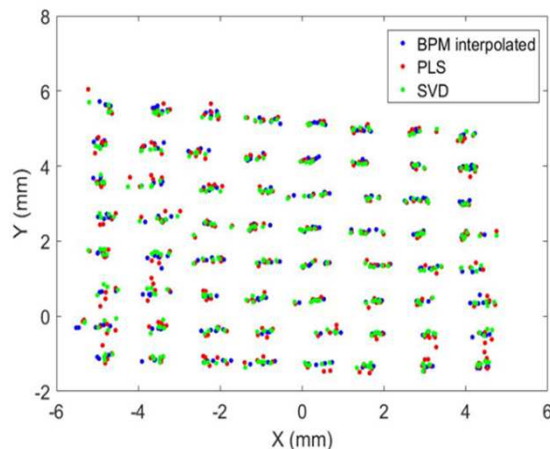

Predicted beam positions in ACC5-CAV4

- The prediction data was also measured on April 4th in module ACC5.
- The PLS and SVD method was used to calculate the calibration matrix and predict beam positions in all cavities.
- A resolution around $10 \mu\text{m}$ has been achieved in module 5.

Signal Fitting

- The HOMBPM waveform calibration loses its reliability over a long time because of phase drifts. It is difficult to reliably calculate and correct the phase drift from the waveform directly. Therefore we want to estimate the phase drifts by fitting the dipole mode signal.
- The dipole mode signal mainly consists of two components corresponding to the two signal peaks in the frequency domain. Signal fitting can give the latent information, such as the phase, independent amplitude and decay constant of each peak.

$$A = a_0 + a_1 \sin(\omega_1 t + \varphi_1) e^{-\frac{t}{\tau_1}} + a_2 \sin(\omega_2 t + \varphi_2) e^{-\frac{t}{\tau_2}}$$

- A method based on genetic algorithm (GA) is used to fit the signal waveforms.
- The original signal waveform (blue) and the fitted signal curve (red). The red curve and the original signal are basically coincident. The STD of the signal difference is 25.2 bits ($\sim 1\%$ error) while the coefficient of determination (r^2) is over 0.990.

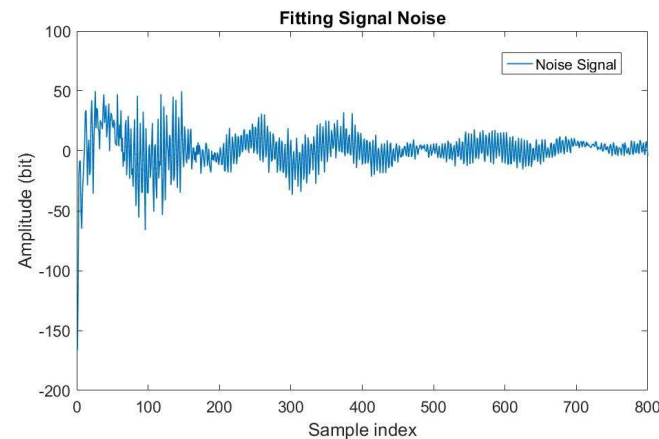
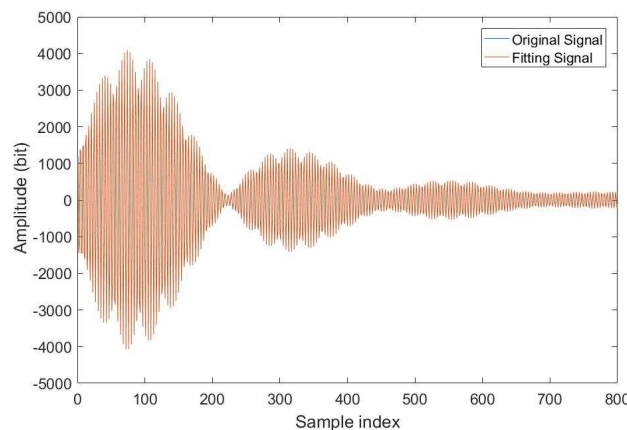

Beam Position Prediction Over Long Time

Predicted beam positions on May. 25th in ACC5-CAV3 with fitting method.

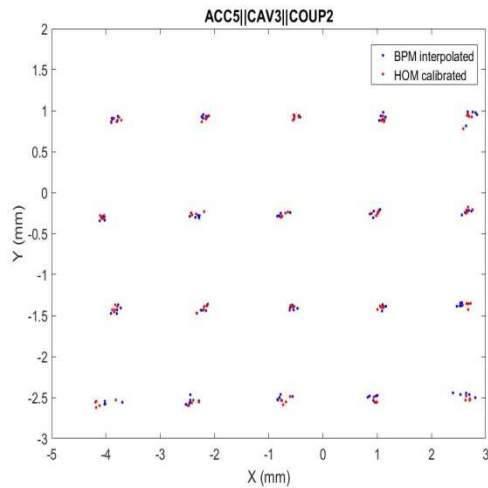

RMS	X (mm)	Y (mm)
Calibration	0.102	0.058
Prediction	0.110	0.064

Predicted beam positions on Feb. 5th in ACC5-CAV4 with fitting method.

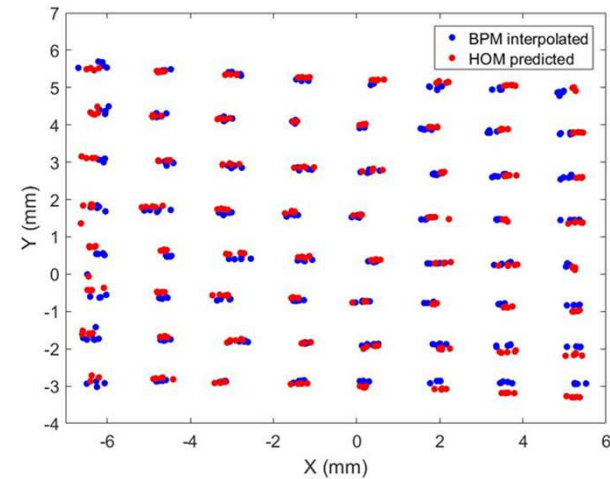

RMS	X (mm)	Y (mm)
Calibration	0.108	0.067
Prediction	0.153	0.137

- There is a phase drift in the HOM waveforms over a long time. Therefore the calibration matrix based on waveforms does not work. A new method based on signal fitting is implemented. The fitted mode amplitudes are used to build the signal matrix. This new method gives better result.

HOMBPM RMS

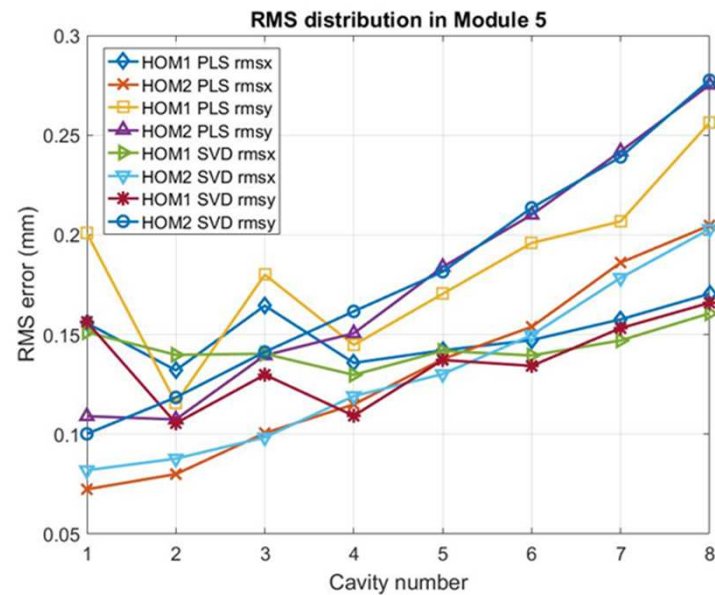

RMS error of HOM beam predicted positions (in a short time) in each cavity in ACC5 with SVD and PLS methods.

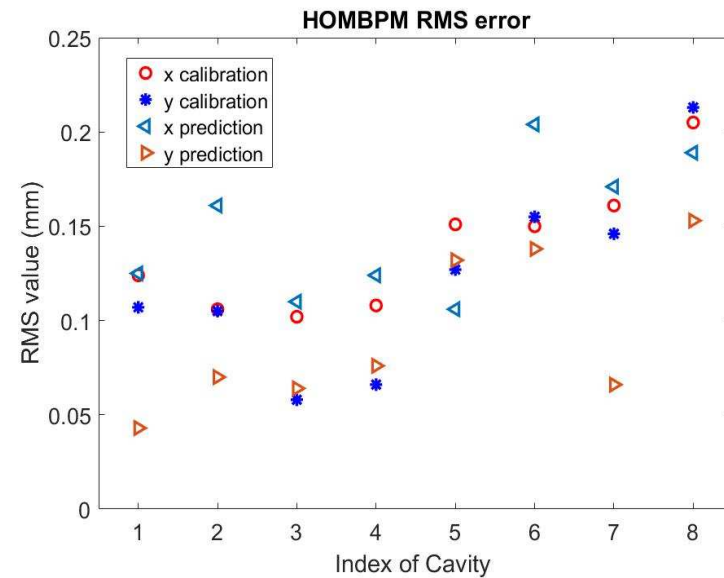

RMS error of HOM beam calibrated and predicted positions (over a long time) in each cavity in ACC5 with signal fitting methods.



- A brief Introduction to HOM based beam diagnostics
- HOM based beam position measurement
- **HOM based long-term beam phase measurement**
- HOM based cavity tilt measurement
- Summary



Beam Phase Concept

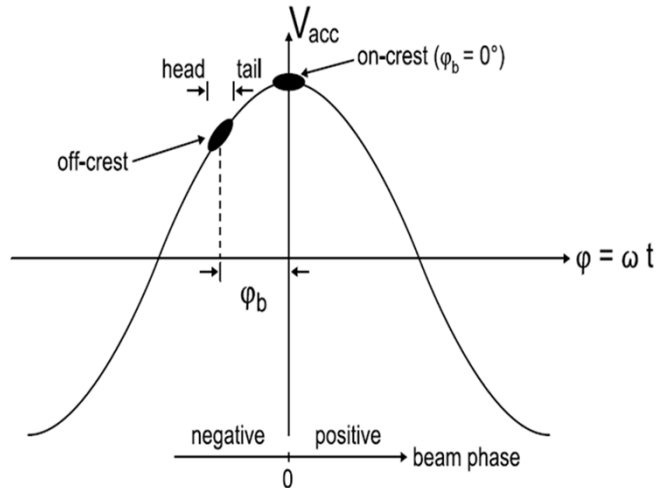

- We define the beam phase according to the time difference between these two instants: when the beam passes the cavity and when the accelerating gradient in the cavity is maximum.
- If the RF field reach its maximum when the beam passes through the cavity, the beam has max energy gain.
- Beam phase 0 is defined as on-crest.

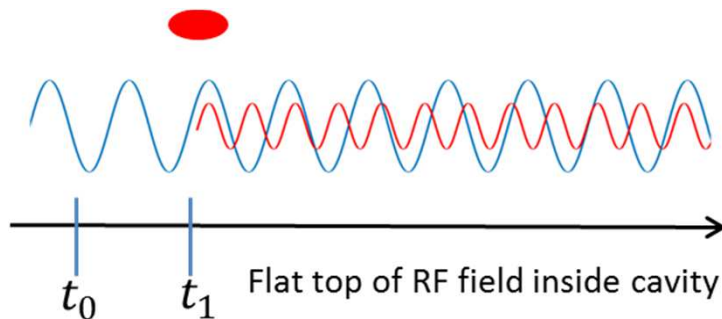

RF_{t_0} : 1.3 GHz signal

V_b : ~2.4 GHz beam induced signal

$$RF_{t_1} = RF_{t_0} + V_b$$

Vector-Sum Control

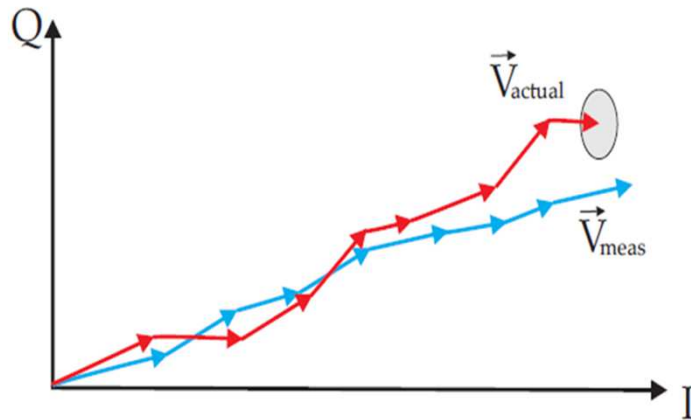
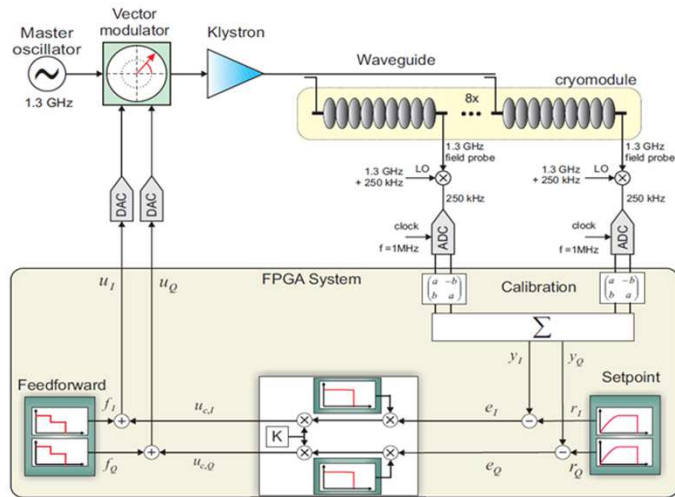

- The Low Level Radio Frequency (LLRF) system is responsible for regulation of the accelerating field in the cavities used for a particle accelerator. This includes the generation of control signals, timing and synchronization, signal acquisition and digital signal processing.
- The LLRF system requires a stability of the RF amplitude and phase to be below 0.01% and 0.01° RMS at FLASH and the European XFEL.
- The accelerating voltage vector of the whole ACC-module is obtained by measuring the field vector of each single cavity by probe and calculating the field vector-sum of all cavities in one or more modules.
- The vector-sum system needs fewer klystrons, and therefore can reduce the cost.
- The disadvantage of the vector-sum is that the single cavities are not individually controlled. The actual situation in each cavity is underdetermined.

Measurement Setup

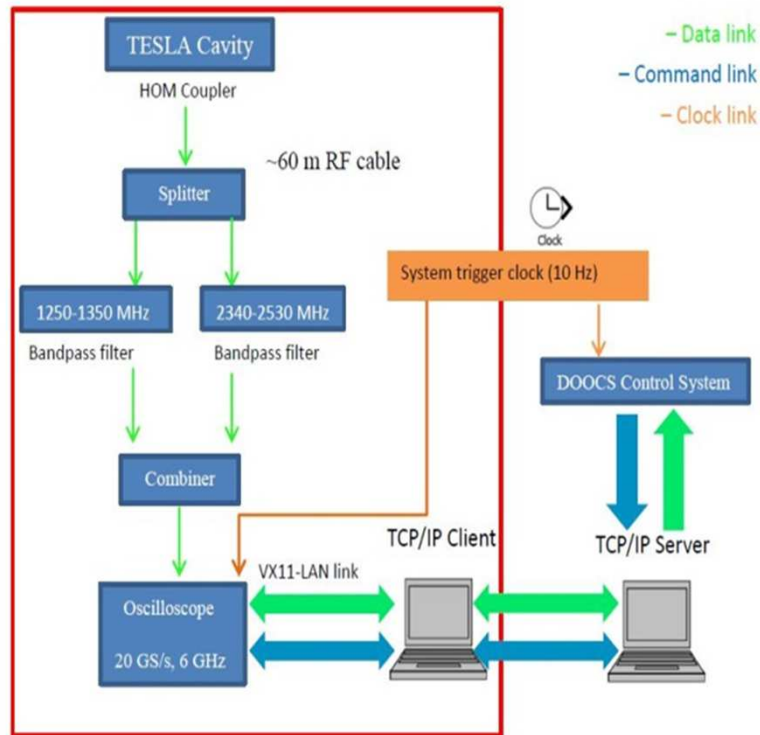

- The two HOM couplers on each cavity deliver the signal for the two channels used for beam phase measurement.
- The setup consists of two kinds of RF bandpass filters (one centered at approximately 1300 MHz with 100 MHz bandwidth and the other approximately 2435 MHz with 190 MHz bandwidth), combiner/splitter (5-2500 MHz), and a fast scope (Tektronix TDS6604B, 20 GS/s with 6 GHz bandwidth).
- One PC serves as a TCP/IP client and a second one as a server for collecting data from the control system.

Signal Processing

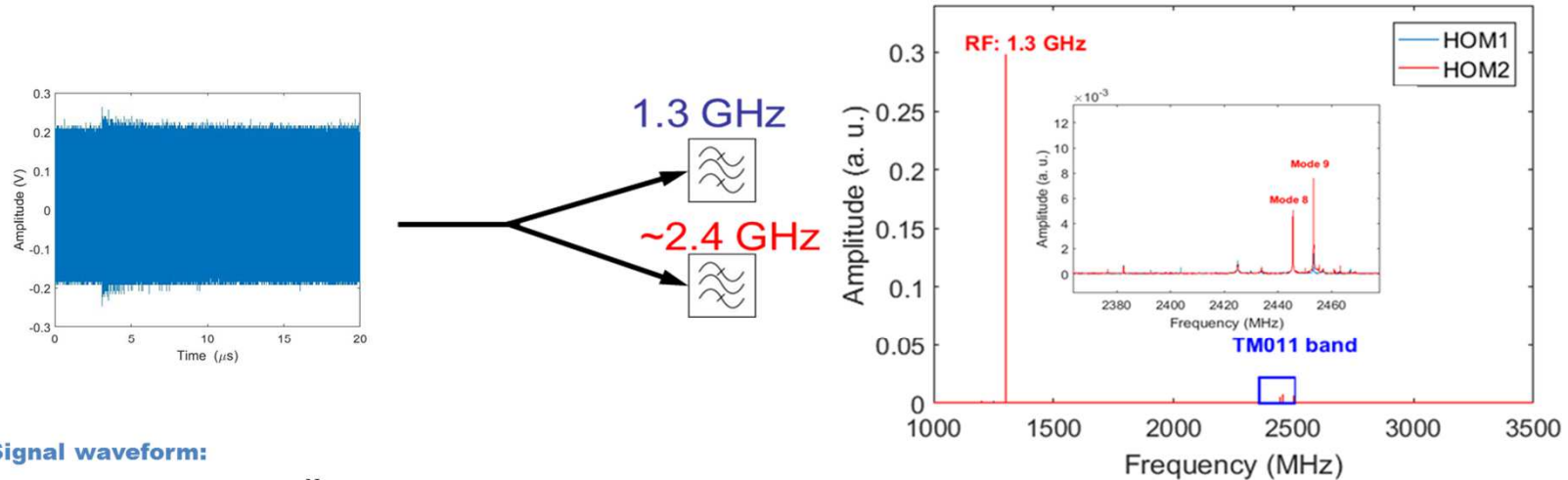

Signal waveform:

$$x(t) = a_0 + \sum_{n=1}^N (a_n \cos(\omega_n t) + b_n \sin(\omega_n t))$$

Fourier coefficients:

$$a_n = \frac{2}{T} \int_0^T x(t) \cos(\omega_n t) dt$$

$$b_n = \frac{2}{T} \int_0^T x(t) \sin(\omega_n t) dt$$

Mode amplitude and phase:

$$A_n = \sqrt{a_n^2 + b_n^2}; \varphi_n = \arctan 2(a_n, b_n)$$

Beam phase:

$$\varphi_{beam} = \varphi_0 - \omega_0 \cdot \sum_n \frac{w_n \varphi_n}{\omega_n}$$

- The signal contains the RF leakage, the beam excited mode at 1.3 GHz and the beam excited TM011 mode.
- Mode 8 and mode 9 in TM011 band are excited strongly due to high R/Q (75 Ohms).
- The signal can be decomposed into a Fourier series of simple oscillating functions.
- φ_0 and ω_0 are the phase and angle frequency of the accelerating RF at 1.3 GHz, w_n is the weight factor of mode n according to its power.

Signal Analysis

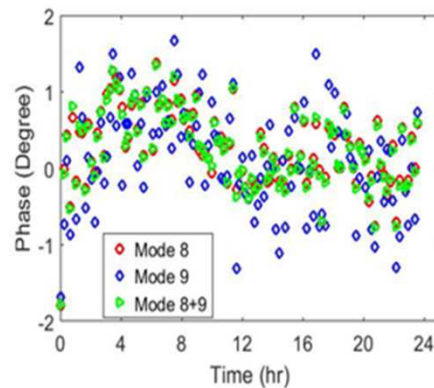

(a) HOM1

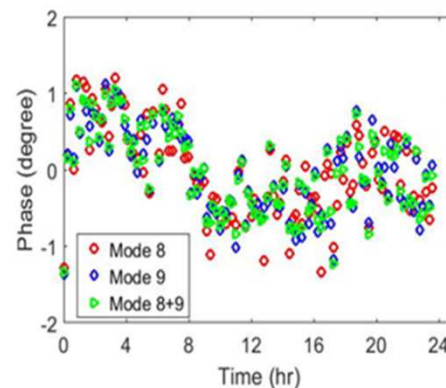

(b) HOM2

- Data was measured in one day. The probe phase remains basically the same.
- Beam phase measurement by using mode 8 (red), mode 9 (blue) and both modes (green) from HOM1 (a) and HOM2 (b).
- The beam phase resolution, based on the two HOMs signals, is 0.30° for mode 8, 0.43° for mode 9 and 0.27° when using both.

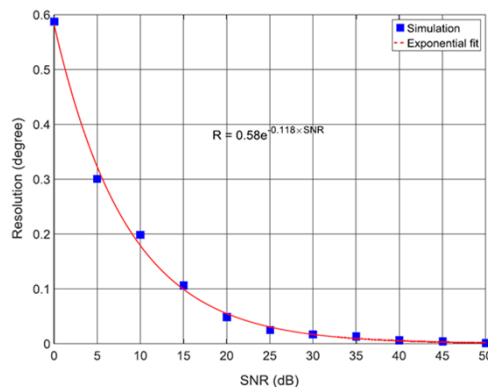

*Reference: L. Shi, Ph. D thesis, 2017

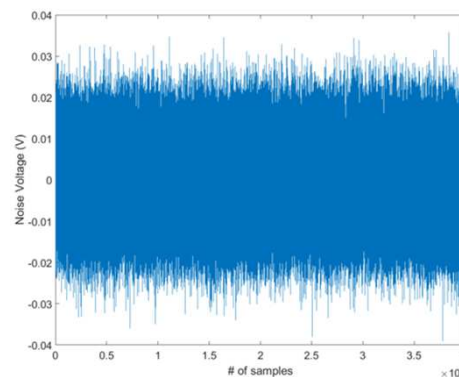

Noise

- The resolution of the HOM-BPhM system is highly dependent on the noise level according to a simulation study*.
- The simulation is based on a beam driven circuit model simulation.
- The noise can be estimated from the signal waveform by using SVD method (~ 10 dB).
- For 10 dB SNR, the expected resolution is 0.2°
- The measurement resolution is consistent with the simulation result.



Long-term Beam Phase Measurement result

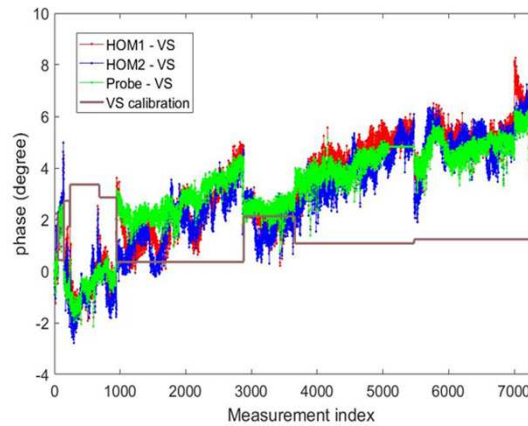
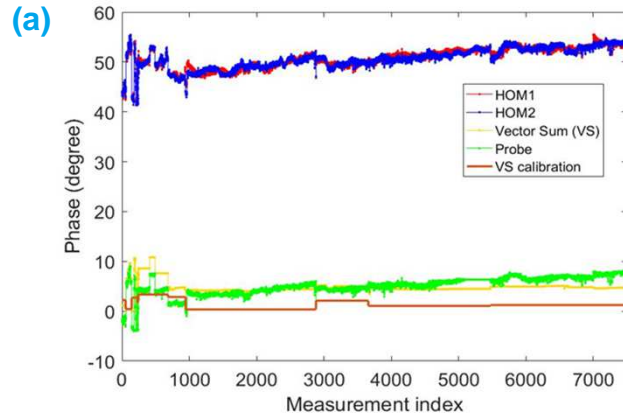

- From August 1st to 21st, the beam phase was measured in cavity 1 of ACC1 at FLASH. The RMS of the phase difference between HOM1 and HOM2 is 0.41° .

(b)

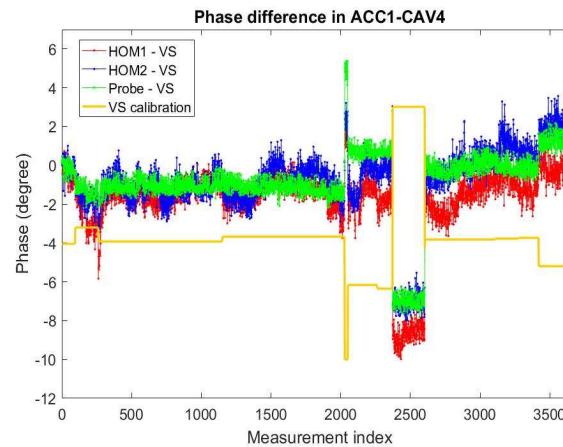
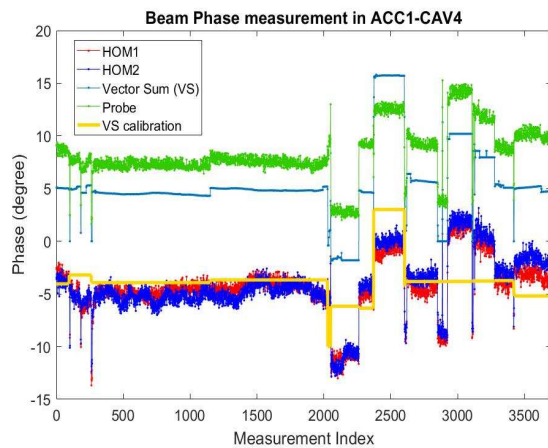

- From Sept. 24th to Nov. 13th, the beam phase was measured in cavity 4 of ACC1 at FLASH. The RMS of the phase difference between HOM1 and HOM2 is 0.62° .

- A brief Introduction to HOM based beam diagnostics
- HOM based beam position measurement
- HOM based long-term beam phase measurement
- **HOM based cavity tilt measurement**
- Summary



Experiment Setup

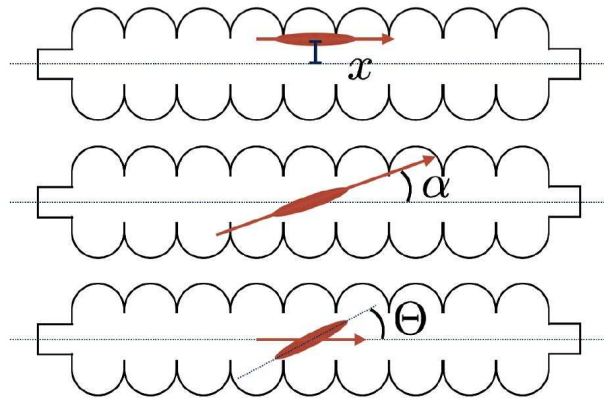

- There are three scenarios of a bunch traveling through a cavity.

(a) the bunch travels with an offset,

(b) the bunch travels with an angle with respect to cavity axis,

(c) the bunch is tilted.

$$V_x(t) \propto x \cdot e^{-\frac{t}{2\tau}} \sin(\omega t)$$

$$V_\alpha(t) \propto \alpha \cdot e^{-\frac{t}{2\tau}} \cos(\omega t)$$

$$V_\Theta(t) \approx 0 \quad (\text{ultra short pulse})$$

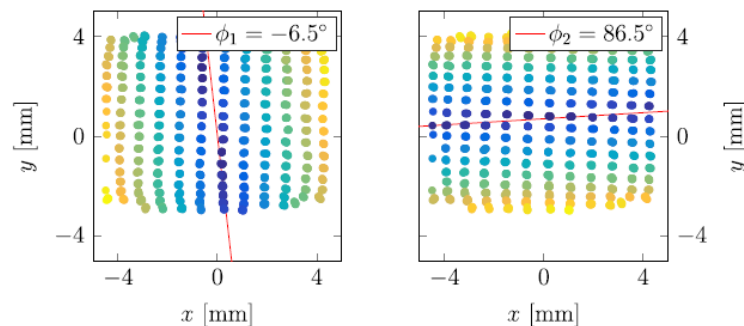
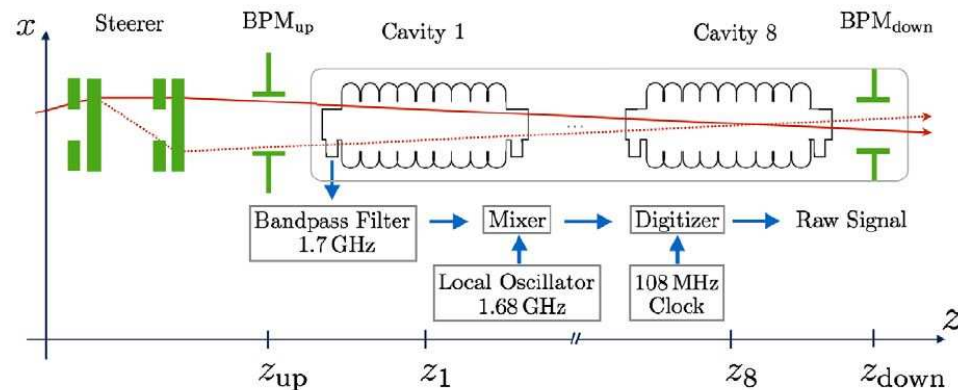

- The RF is switched off and quadrupoles are cycled to zero, assuring a drift space between the two BPMs.
- Two pairs of steerers are used to move the beam in 4D dimensions.
- Ideally, we want to make the beam always pass through the center of one cavity. But it is too difficult. Otherwise, we make dense scans trying to fill the 4D (x, x', y, y') space.
- Transverse polarization axes in cavity need to be determined..

Previous Results

❖ Random Scan (ACC2-CAV2)

Thorsten Hellert, *et al*, *Phys.Rev.Accel.Beams* **20** (2017), 123501.

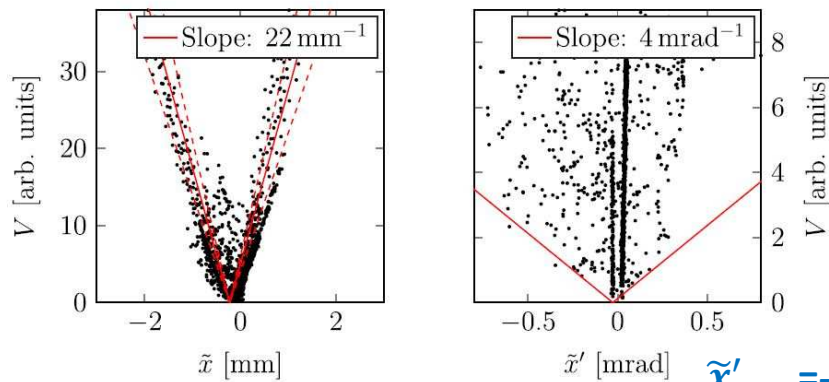

V_{mode2} in Polarization \tilde{x}

$\tilde{x}'_{cav} = -3 \mu\text{rad}$

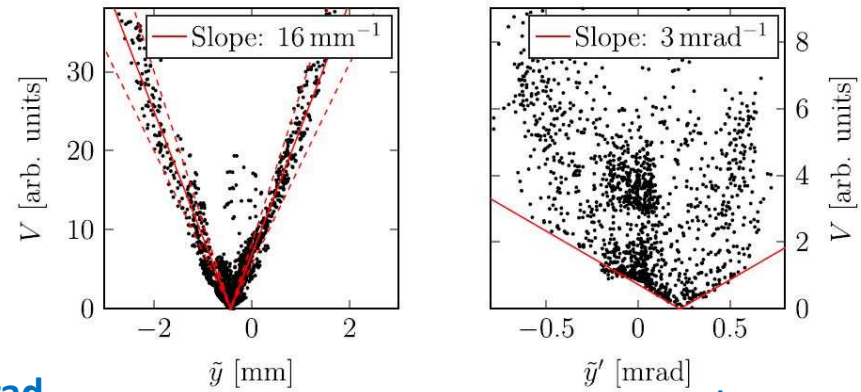

V_{mode1} in Polarization \tilde{y}

$\tilde{y}'_{cav} = 216 \mu\text{rad}$

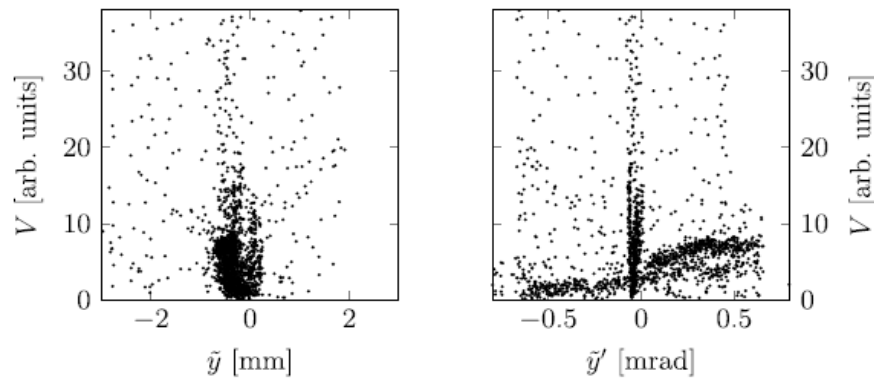

V_{mode2} in Polarization \tilde{y}

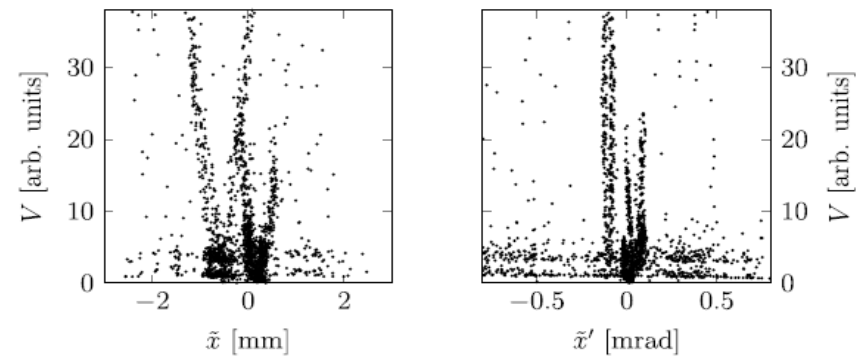

V_{mode1} in Polarization \tilde{x}

The ratio between the offset and angle dependence of the dipole mode amplitude is about 1 mm : 5 mrad.



- A brief Introduction to HOM based beam diagnostics
- HOM based beam position measurement
- HOM based long-term beam phase measurement
- HOM based cavity tilt measurement
- **Summary**



Summary

❖ HOM-BPM

- The existing HOM-BPM system can deliver transverse beam position information, like a cavity BPM.
- Waveform can only be used when there is no phase difference between calibration data and prediction data.
- With a newly developed method based on signal fitting we obtained a lower RMS error of around 0.15 mm over months in all cavities in module ACC5.

❖ HOM-BPhM

- The HOM-BPhM system gives good result for long term beam phase measurements. The noise level limits its performance.
- The HOM phase and the probe phase have the same trend over a long time. Also, some phase drifts are observed.
- An electronics based on direct sampling, now under development, is expected to improve the resolution.

❖ Cavity Tilt Measurement

- In ACC2-CAV2, the correlation between cavity tilt angle and dipole modes amplitude was observed.
- More measurements are required to obtain result in more cavities.

Thank you for your attention!

