

Analysis of combined Silicon-TPOL calorimeter data

From η - γ transformation towards an average energy response function

Blanka Sobloher
POL2000 meeting, 26th March 2008

- Archaeology: Inspecting the geometry of the two calorimeters
- Developing η - γ transformation: “3rd component“
- The case of converted and nonconverted photons
- Energy response: structural and calibrational effects
- Towards extrapolation: Energy loss at backplane
- Outlook and resumé

Archaeology - TPOL calorimeters: "Spare"

- After HERA shutdown: "Spare" calorimeter taken out of the tunnel

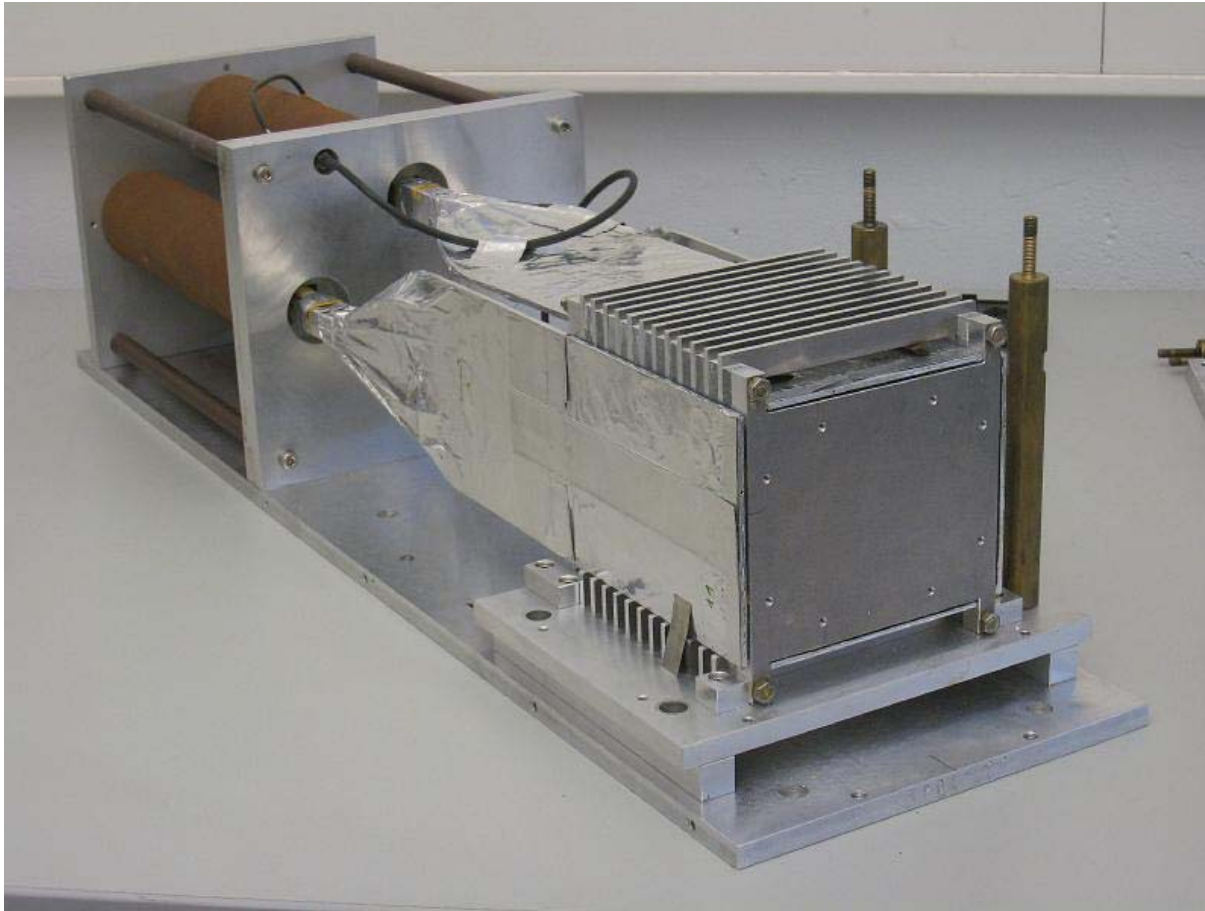

More fotos at <http://www.desy.de/~sobloher>

Archaeology - TPOL calorimeters: "Spare"

- After HERA shutdown: "Spare" calorimeter taken out of the tunnel



More fotos at <http://www.desy.de/~sobloher>

Archaeology - TPOL calorimeters: "Spare"

- After HERA shutdown: "Spare" calorimeter taken out of the tunnel

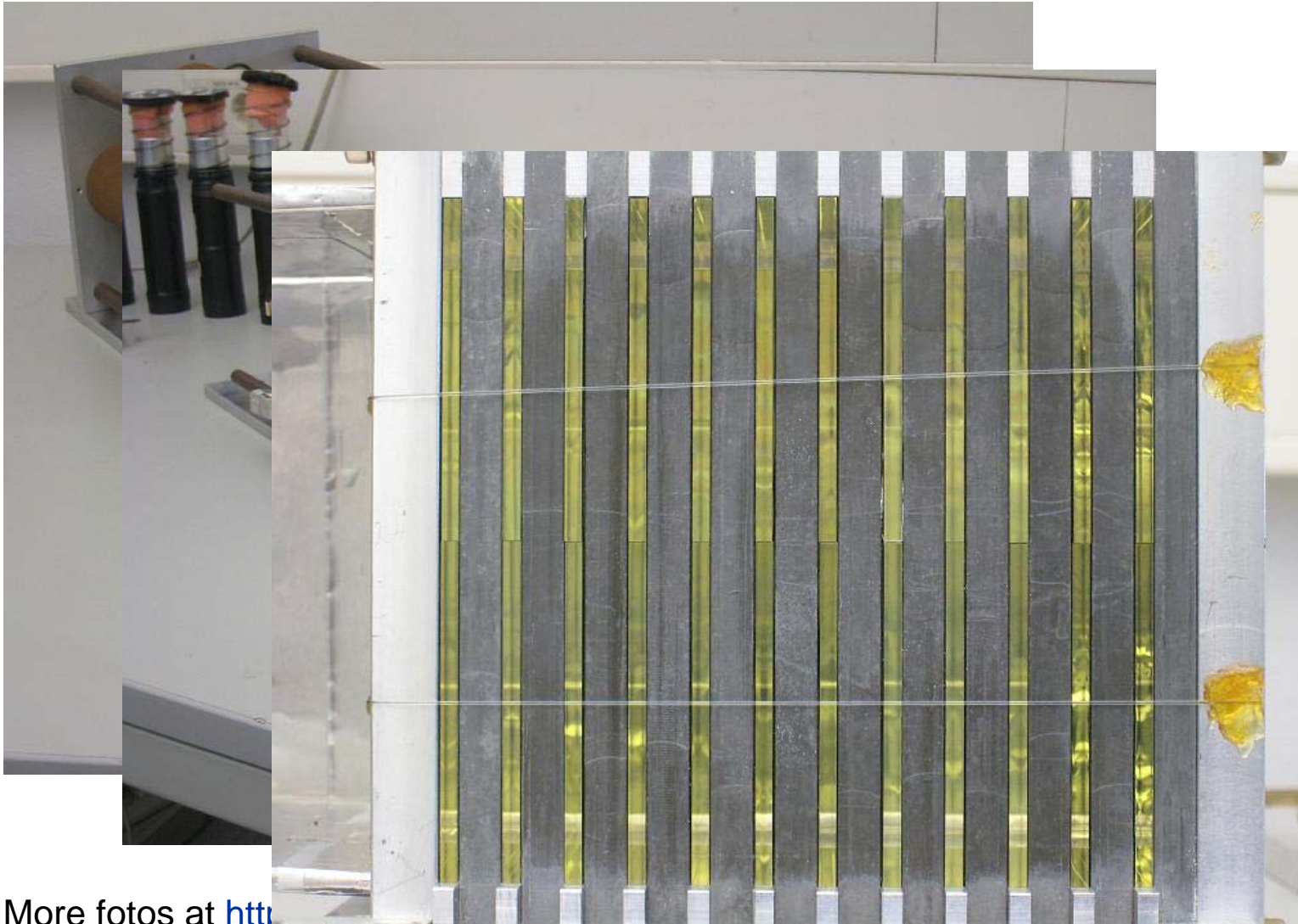

More fotos at <http://www.hera-hamburg.de>

Archaeology - TPOL calorimeters: "Spare"

- After HERA shutdown: "Spare" calorimeter taken out of the tunnel

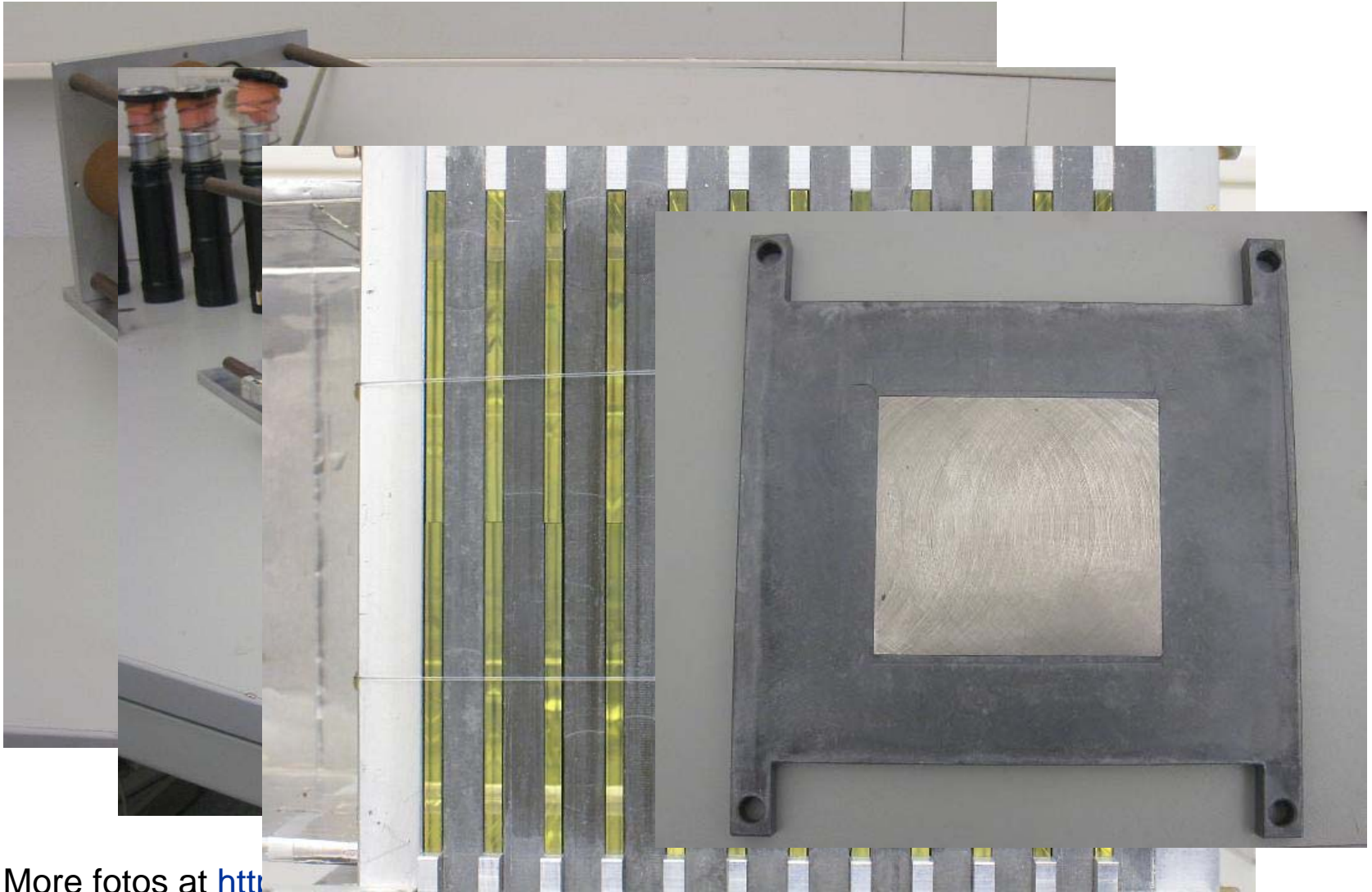

More fotos at <http://www.hera-freilichtmuseum.de>

Archaeology - TPOL calorimeters: “Spare“ and “Old“

- After HERA shutdown: “Old“ calorimeter case opened for comparison

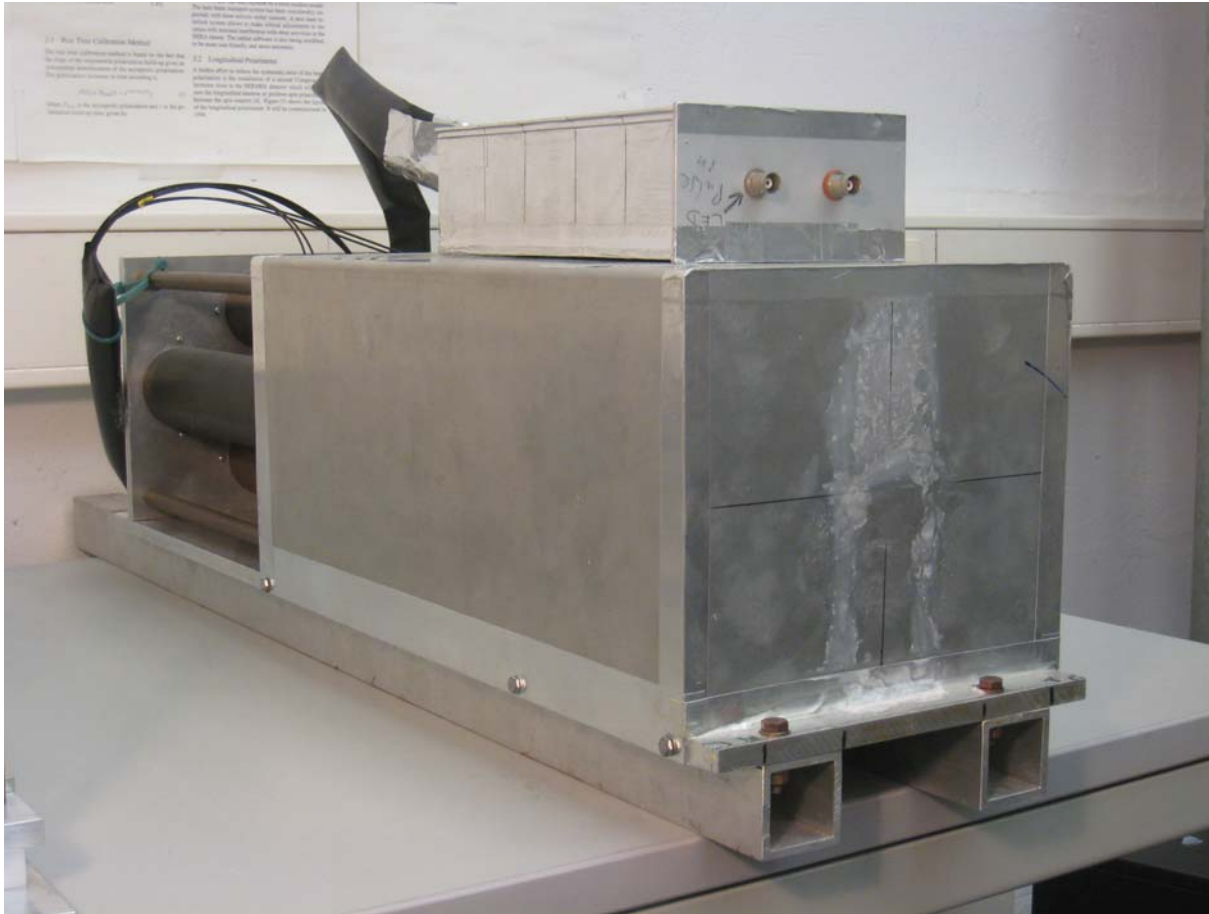

More fotos at <http://www.desy.de/~sobloher>

Archaeology - TPOL calorimeters: “Spare“ and “Old“

- After HERA shutdown: “Old“ calorimeter case opened for comparison

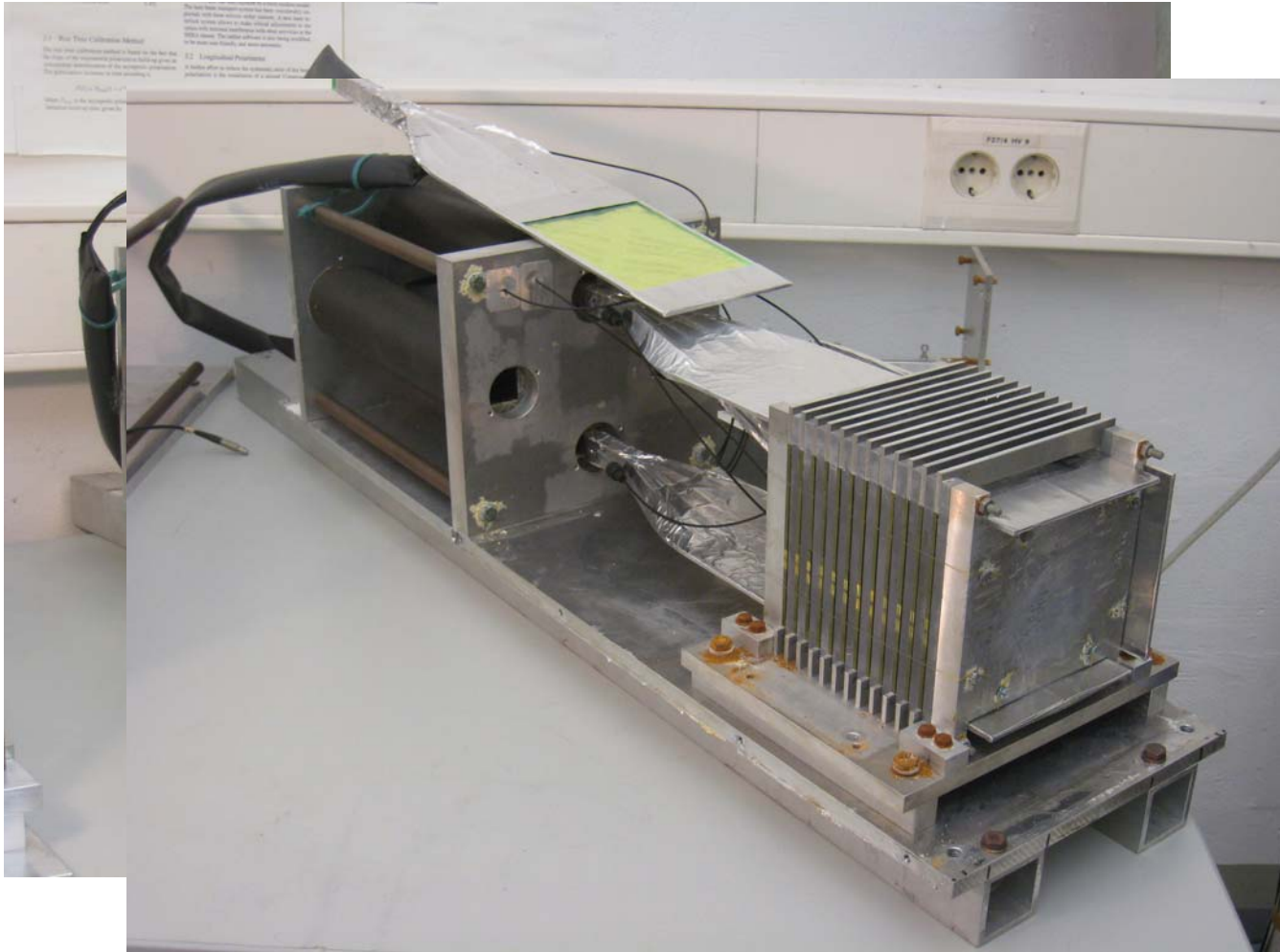

More fotos at <http://www.desy.de/~sobloher>

Archaeology - TPOL calorimeters: “Spare“ and “Old“

- After HERA shutdown: “Old“ calorimeter case opened for comparison

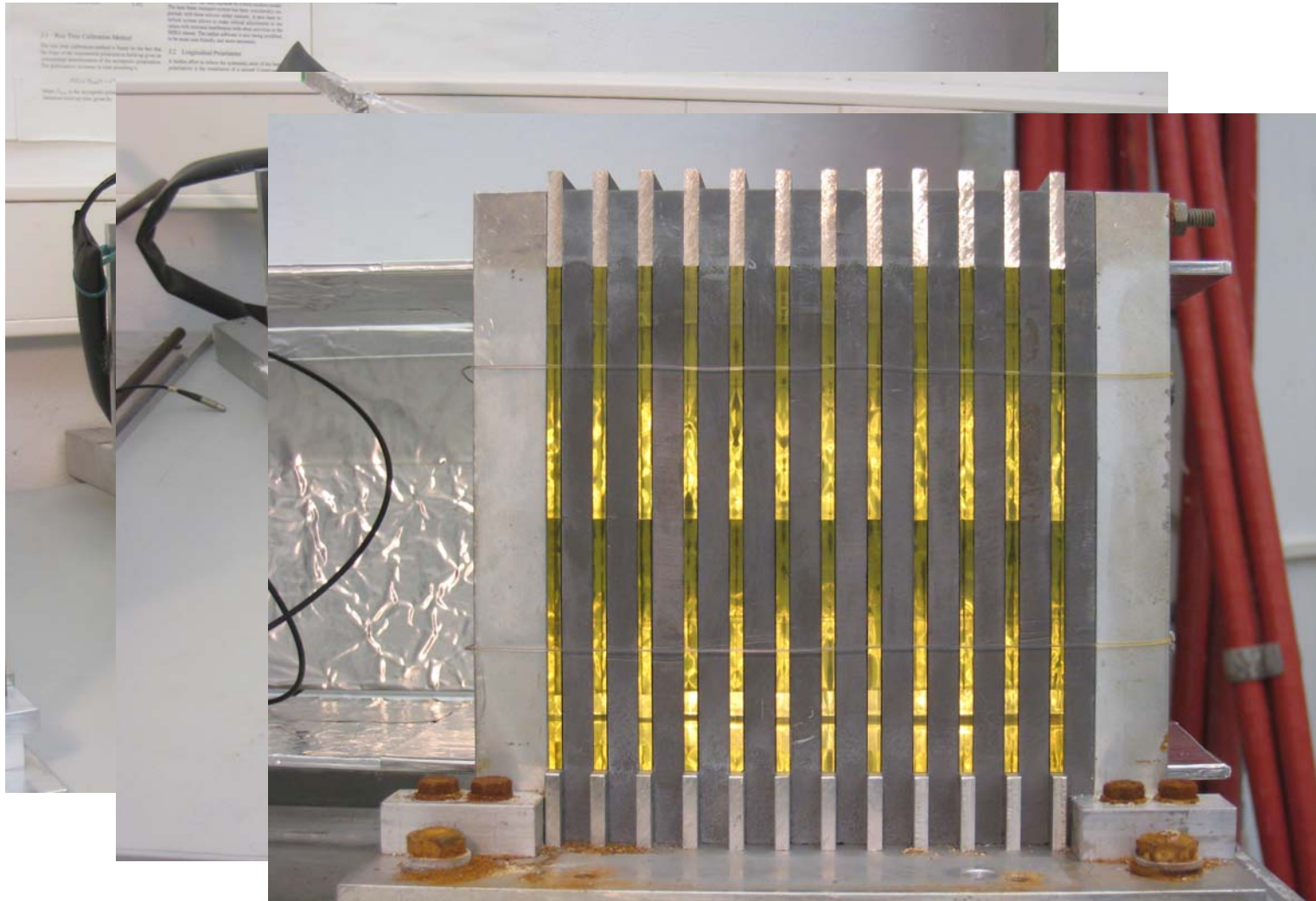

More fotos at <http://www.desy.de/~sobloher>

Archaeology - TPOL calorimeters: “Spare“ and “Old“

- After HERA shutdown: “Old“ calorimeter case opened for comparison

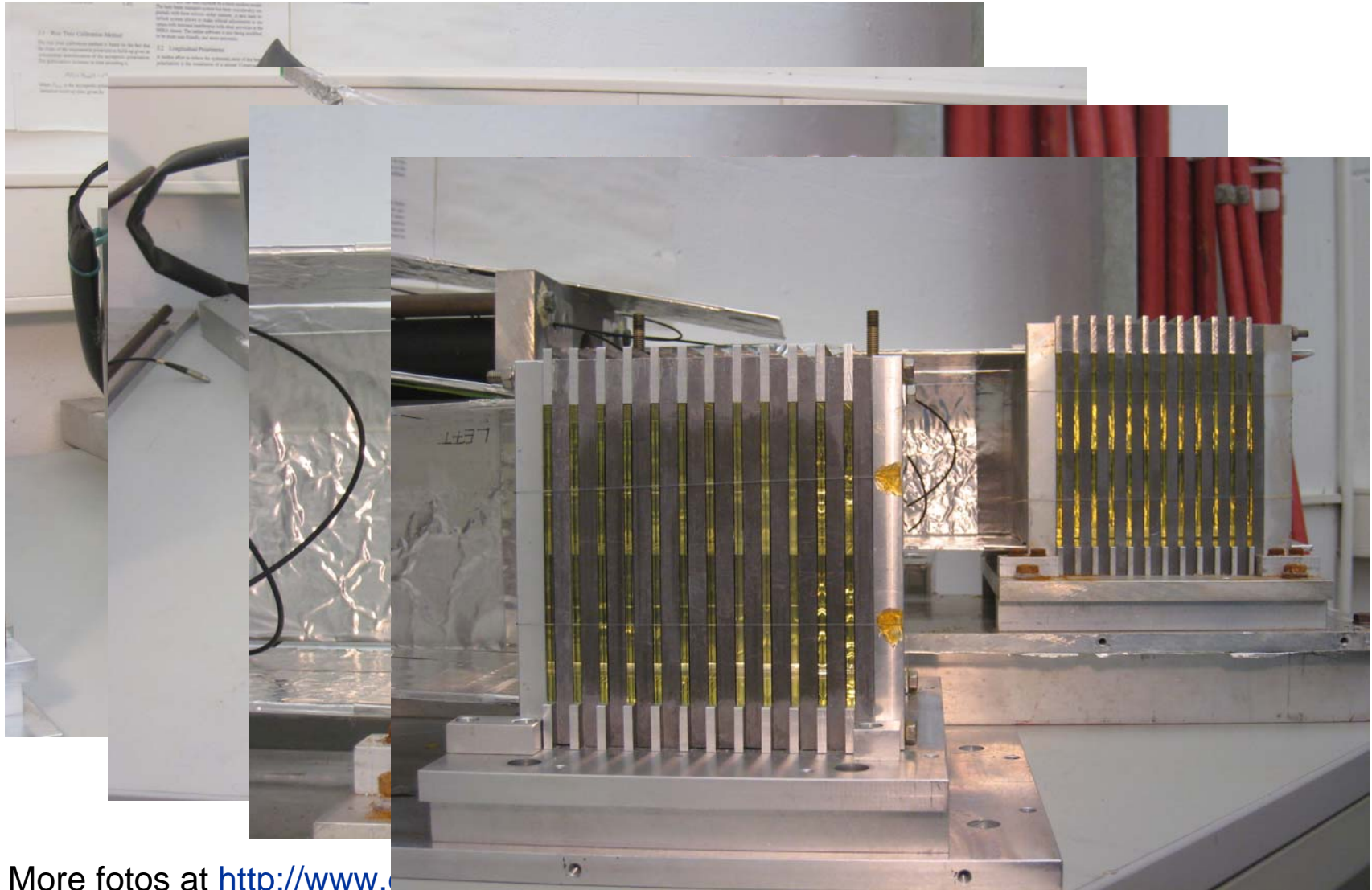

More fotos at <http://www.>

Introduction - Analysing Power and the η - y Transformation

- TPOL is not measuring the vertical coordinate y , but the vertical energy asymmetry η :

$$\eta := \frac{E_u - E_d}{E_u + E_d}$$

- Online measurement by “shift of means” in η

$$\Rightarrow AP(\eta)$$

- Need precise knowledge of the η - y transformation to determine
 - a) Analysing power
 - b) Shape of systematic effects

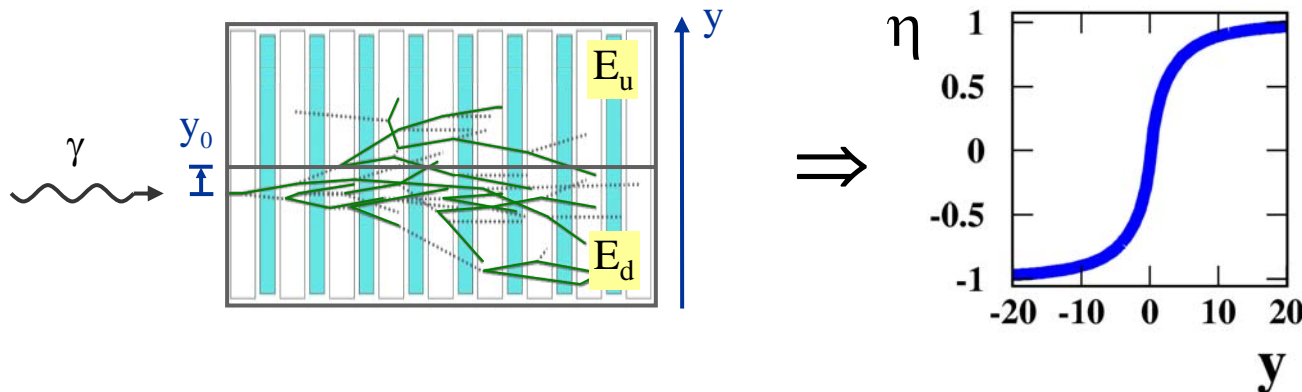
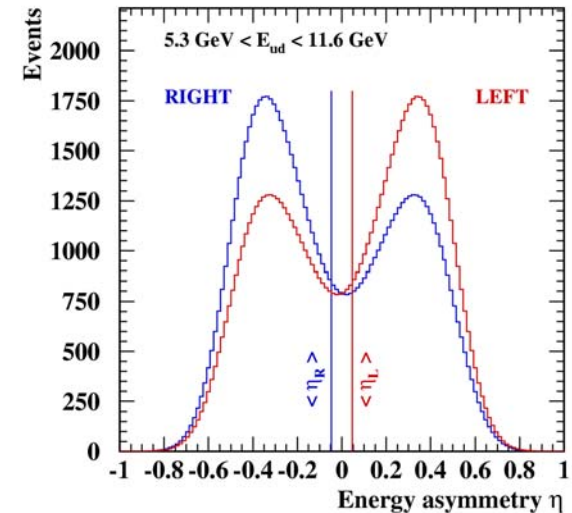

Retrospection - Modelling η - y

- Modelling one em shower by assuming a radial exponential energy distribution
- Proper integration over x and y for η - y leads to an integrated Bessel-Function
- Expect two component shower: core and halo of different shower lengths

$$\frac{dE}{dr} \propto E_0 \cdot e^{-r/\lambda}$$

$$\mathcal{K}_0(y_0) := \frac{2}{\pi} \int_0^{y_0} K_0(t) dt$$

- That's what the literature states for one em **single-particle shower**, e.g.
 - **R. Wigmans**, *Calorimetry*, Oxford Science Publications
 - **G. Bathow**, Nucl. Phys. **B20**(1970) 592;
 - **G. A. Akopdjanov**, Nucl. Instr. Meth. **140**(1977) 441

$$\eta(y_0) = \frac{E_u(y_0) - E_d(y_0)}{E_u(y_0) + E_d(y_0)} = \text{sign}(y_0) \left[c \cdot \mathcal{K}_0\left(\frac{|y_0|}{\lambda_1}\right) + (1-c) \cdot \mathcal{K}_0\left(\frac{|y_0|}{\lambda_1 + \lambda_2}\right) \right]$$

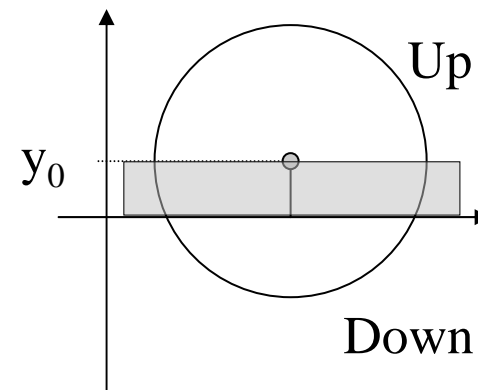
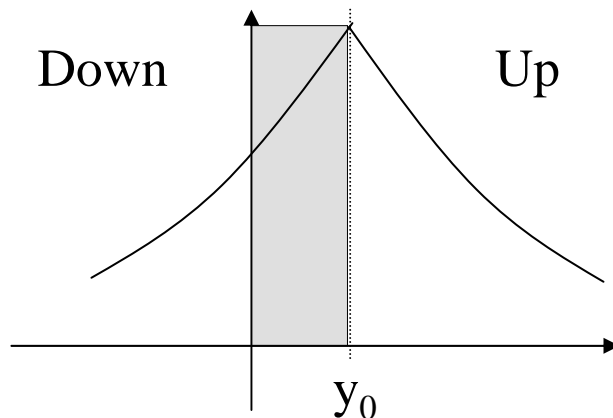
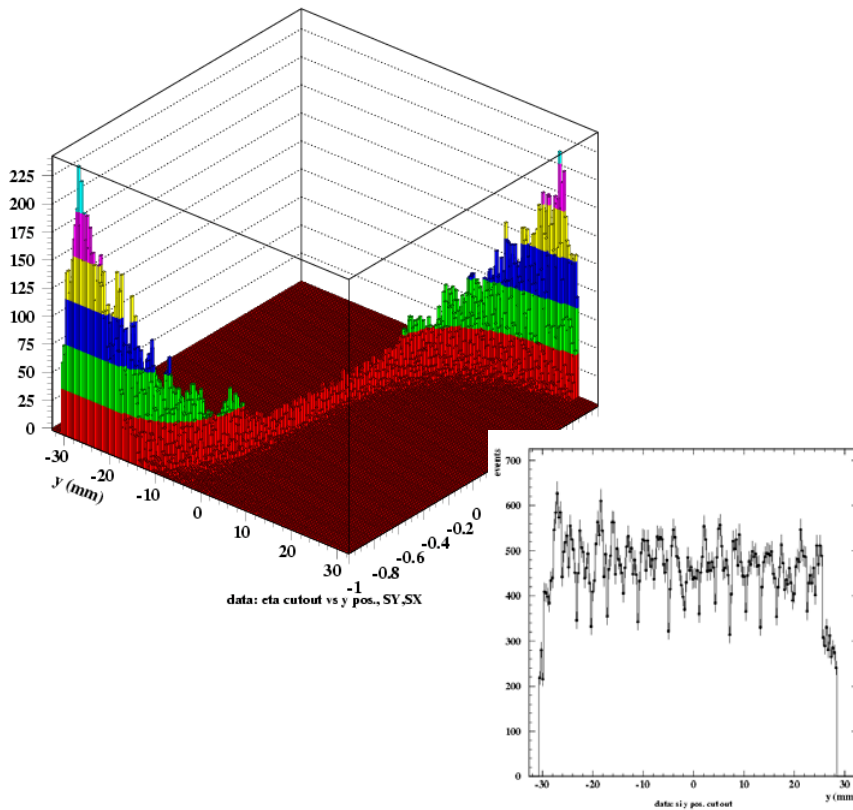

Table scan data - "Old" and "New"

- Data taken in August 2005

- 19 runs à 100k events
- $y \in [-30\text{mm}; 30\text{mm}]$
- fixed step size of 3mm
- limited statistics around $\eta=0$



- Data taken on 30th June 2007

- 70 runs à 100k events
- $y \in [-25\text{mm}; 25\text{mm}]$
- step size adapted to give flat 2D-profile

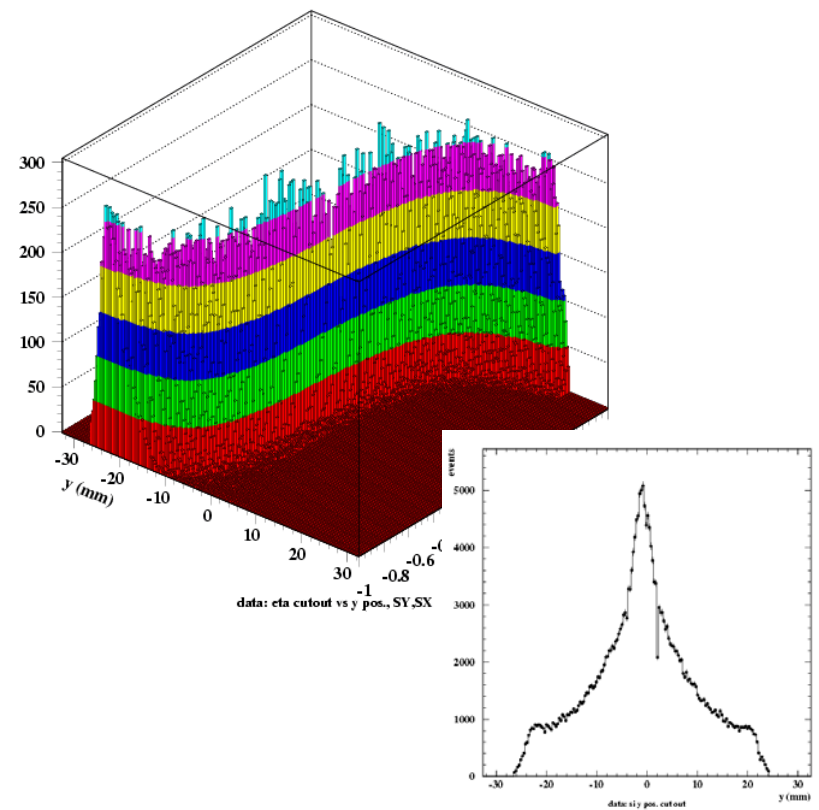

Residua of the fits - A close look

- Residua with respect to the fit to “Old” data
- Each fit has his own offsets y_0 and η_0
 - Have to be nulled to compare data and fit results
- Comparison reveals some common systematic effect !

Data and fit results without y_0 and η_0

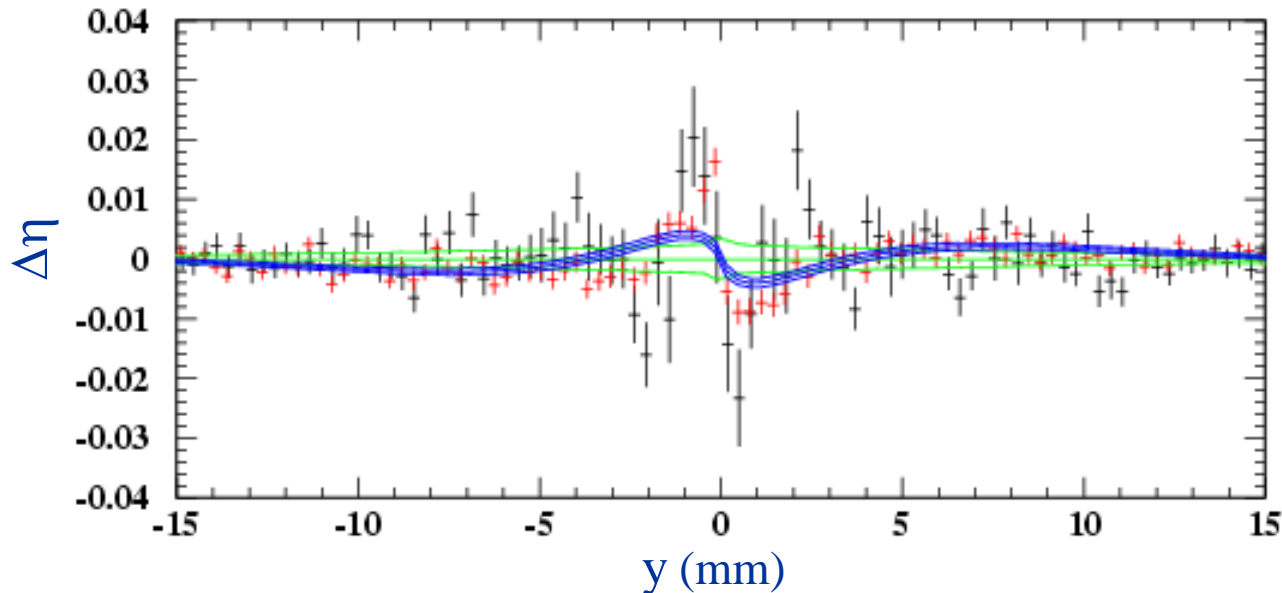

- “Old” data
- Fit to “Old” data
- “New” data
- Fit to “New” data

Going beyond - Developing the modelling of η -y

- For two components the analytical formulation results in

$$\eta(y_0) = \frac{E_u(y_0) - E_d(y_0)}{E_u(y_0) + E_d(y_0)} = \text{sign}(y_0) \left[c \cdot \mathcal{K}_0\left(\frac{|y_0|}{\lambda_1}\right) + (1-c) \cdot \mathcal{K}_0\left(\frac{|y_0|}{\lambda_1 + \lambda_2}\right) \right]$$

- *But the same literature (simulations as well as profile measurements) show also something else above this*

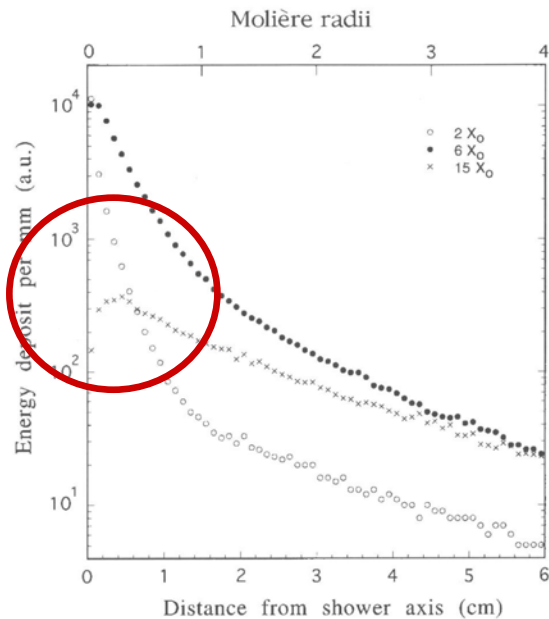

* R. Wigmans, Calorimetry

FIG. 2.13. The radial distributions of the energy deposited by 10 GeV electron showers in copper, at various depths. Results of EGS4 calculations.

- The long length component shows a depletion for very short distances
 - Which are the most interesting for us
 - Interpret this as an additional component: a “3rd component”

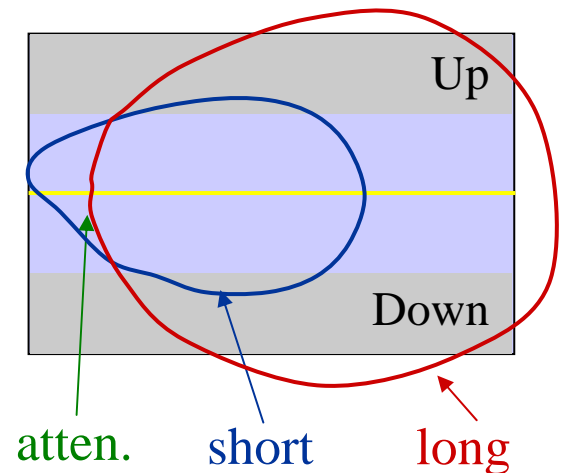

Two distinct event classes - Converted and nonconverted photons

- Preradiator of $1X_0$ of lead causes 54% of the Compton photons to convert
 - Charged particles measurable by silicon planes
 - η - y measured with combined silicon and calorimeter representative for some special converted photons
- Is there a difference between converted and nonconverted photons?
 - Any difference should have a direct influence on the way we model our data
 - This would include estimations of an Analyzing Power using some η - y

➤ Need of extrapolation of a 'silicon η - y ' to a 'polarimeter η - y '

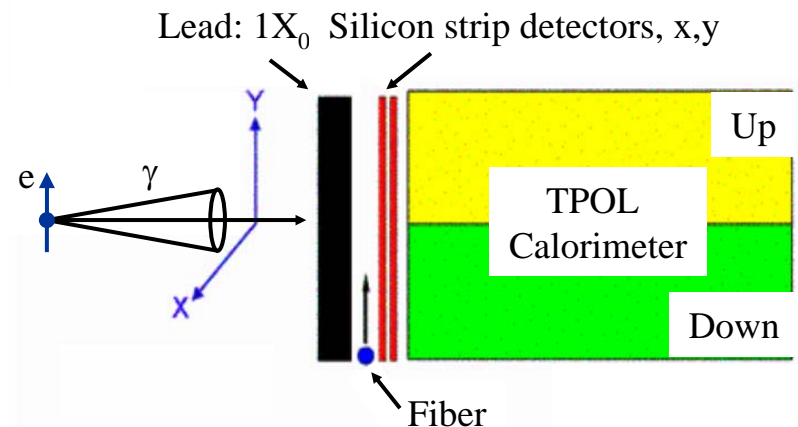
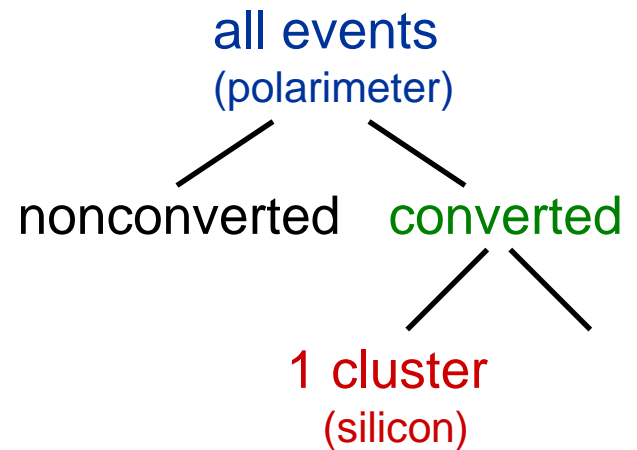

“3rd component” - Key point for multi-particle issues

- Upon conversion photon energy is spread on multiple particles with a fraction of the total energy
 - This particle distribution has a finite width!
- Aluminum front plate in front of the calorimeter enhances spread by 20%

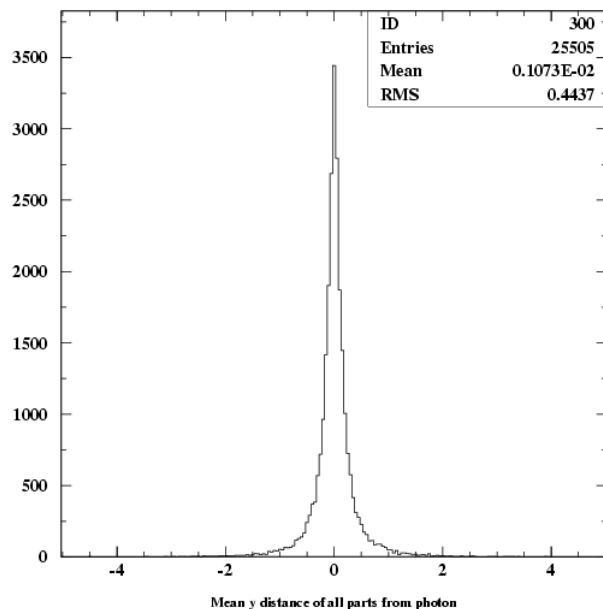
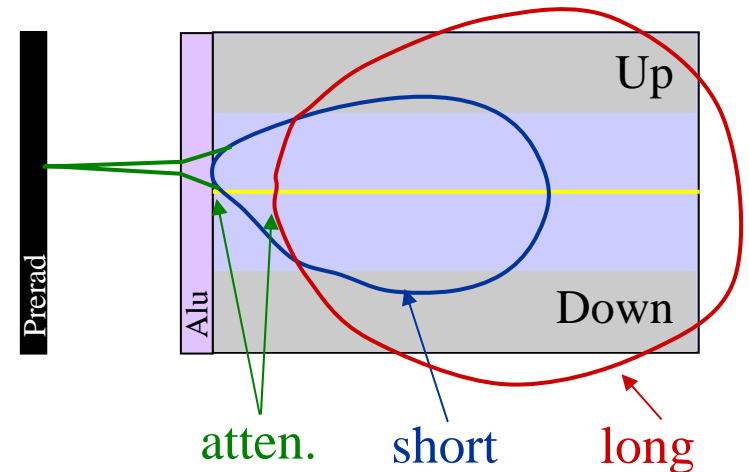

- Multi-particle distributions integrate into the single-particle shower energies E_{up} and E_{down} modelled up to now.
 - Contribution to the “3rd component”
 - Equivalent to a transition of a single-particle shower description to a multi-particle shower description
 - Expect differences for this contribution for converted and nonconverted photons

Ways beyond η - γ - Compton edges in a table scan

- Choosing different cuts
 - No clusters: enrich nonconverted photons
 - Many clusters: enrich converted photons
 - No cuts at all: full mixture of converted and nonconverted photons

➤ Compton edges are moving!

- Fit of Compton edge

- Convoluted Compton spectrum with resolution (only statistical term)

$$\frac{\sigma}{E} = \frac{a}{\sqrt{E}}$$

➤ Resolution also changes

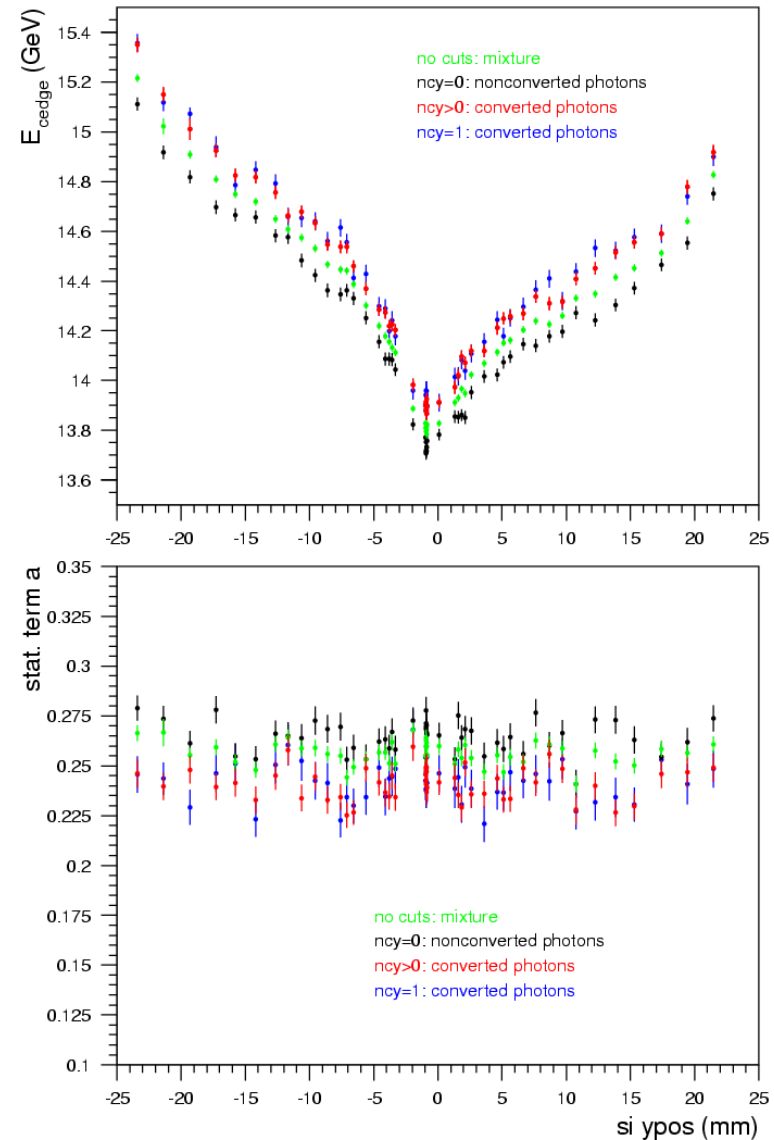

Ways beyond η - γ - Is it an artefact of the edge fit?

- Are the moving edges an artefact of the edge fit?
 - Compare silicon data with enriched converted and nonconverted photons
 - Not an artefact!
 - The edges are really moving!

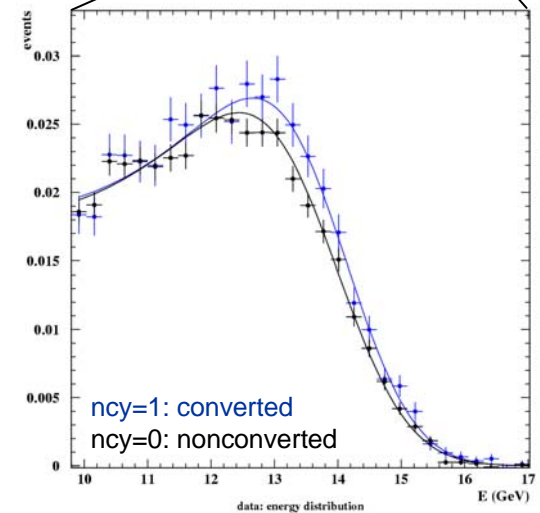
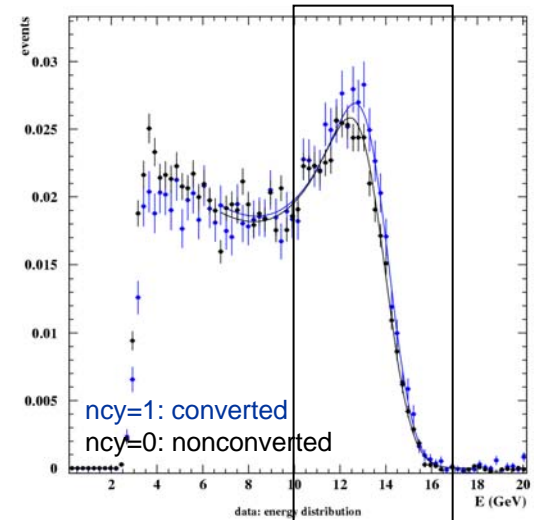

Ways beyond η - γ - Compton edges in a table scan

- Comparing fits of Compton edges
 - No cuts on silicon data
 - Polarimeter data taken at the same time
- Compton edges in the polarimeter data
 - Applied the same conversion factor for ADC channels \rightarrow GeV as in Silicon data
 - Global scale difference of 1% observable
 - Might be due to different signal handling
- Compton edges in the polarimeter data show the same structure as seen with the combined silicon-calorimeter data!
- Energy resolutions in the fit are equivalent!

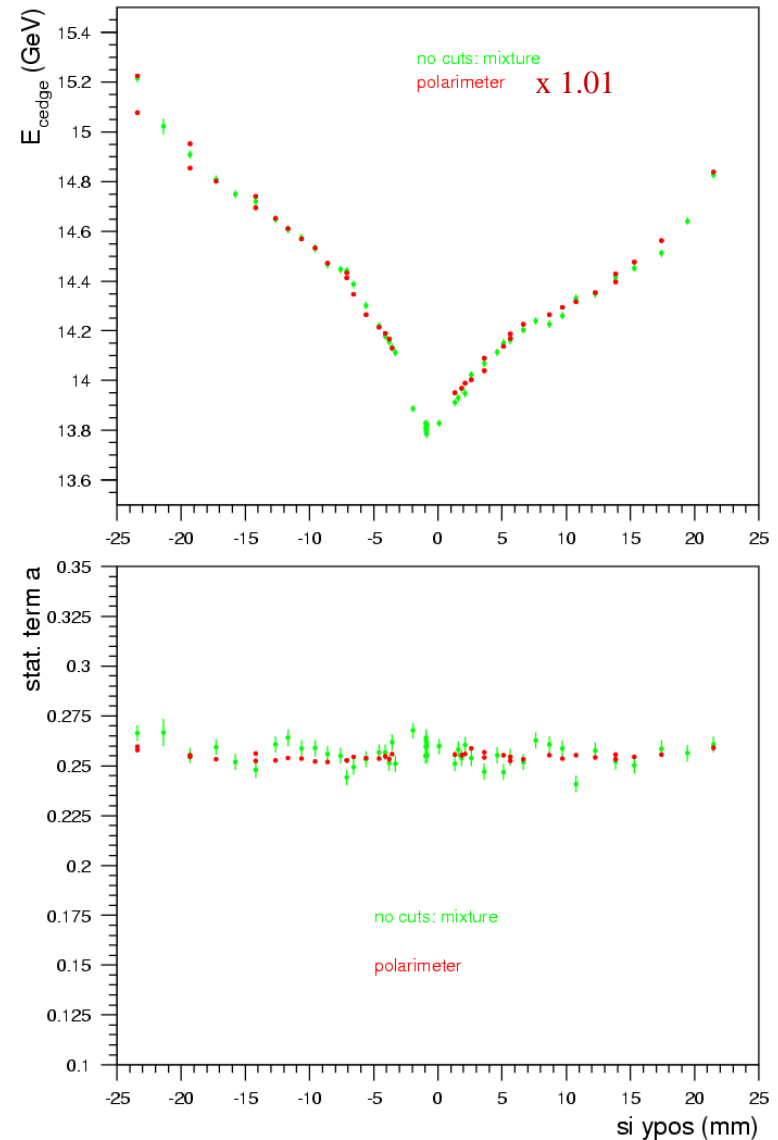

Modelling effects - “Hardware” and calibration

- Funny shape of energy response:

Structural effects of the calorimeter: “hardware”

- Gap between scintillator plates:
 - Energy loss (fraction f)
- Light attenuation in scintillator plates on the way to wavelength shifters
 - Linear model as introduced by Robert:

$$A(y) = a \pm b \cdot y/y_{\max}$$

- Lead frames around tungsten absorber
 - Sampling fraction and Molière Radius
- End of calorimeter structure (absorber and scintillators)
 - Lateral energy loss
- Gain difference
 - Certain small miscalibration

$$G = g \cdot \left(1 \pm \frac{\delta g}{g}\right)$$

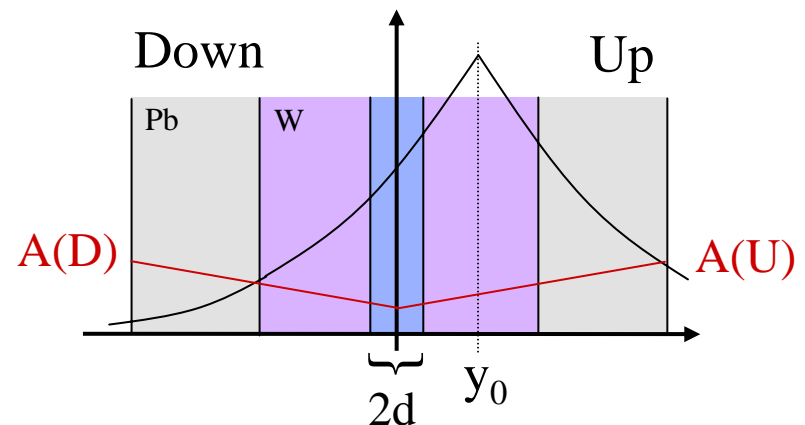
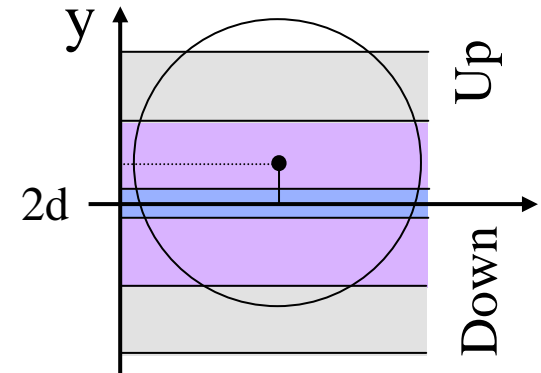

Modelling effects - Quantifying “hardware” and calibration

- All effects induce some changes to η - y and/or energy reconstruction
 - η - y : compare effects with respect to a simple 2-component Ansatz
- Adding induced effects:
 - 3rd shower component
 - Gap with 100% energy loss
 - Linear attenuation
 - Photomultiplier gain difference
 - Lead frames
 - End of scintillators
 - Offset of tungsten absorber
- Note: Energy reconstruction already integrated with gaussian (for later comparison with data)

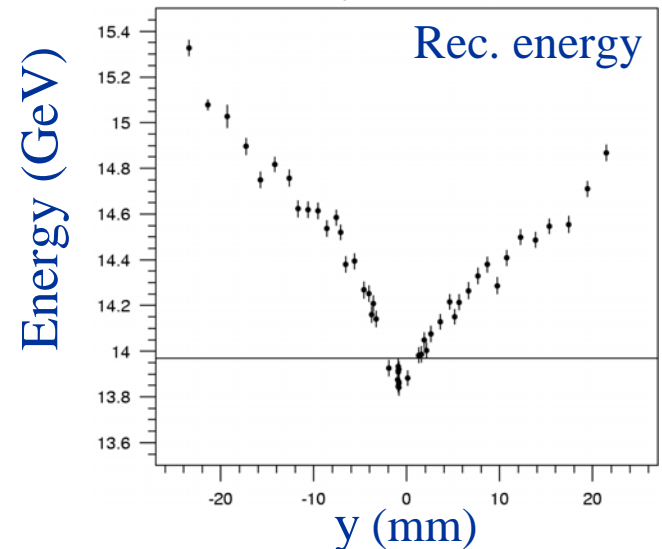
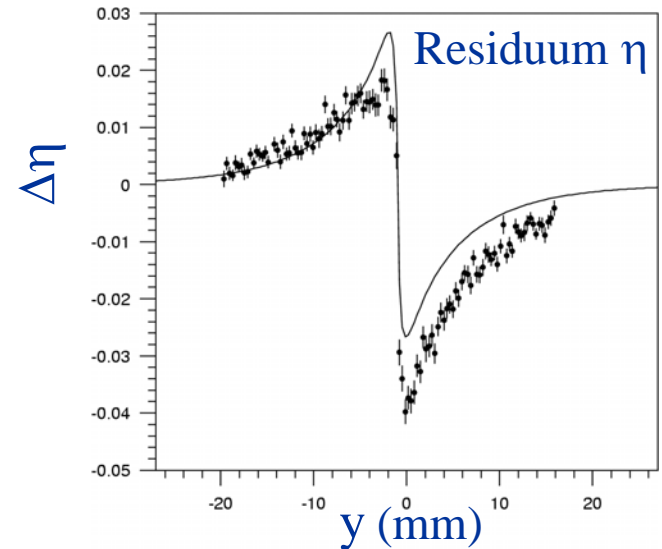

Modelling effects - Quantifying “hardware” and calibration

- All effects induce some changes to η - y and/or energy reconstruction
 - η - y : compare effects with respect to a simple 2-component Ansatz
- Adding induced effects:
 - 3rd shower component
 - Gap with 100% energy loss
 - Linear attenuation
 - Photomultiplier gain difference
 - Lead frames
 - End of scintillators
 - Offset of tungsten absorber
- Note: Energy reconstruction already integrated with gaussian (for later comparison with data)

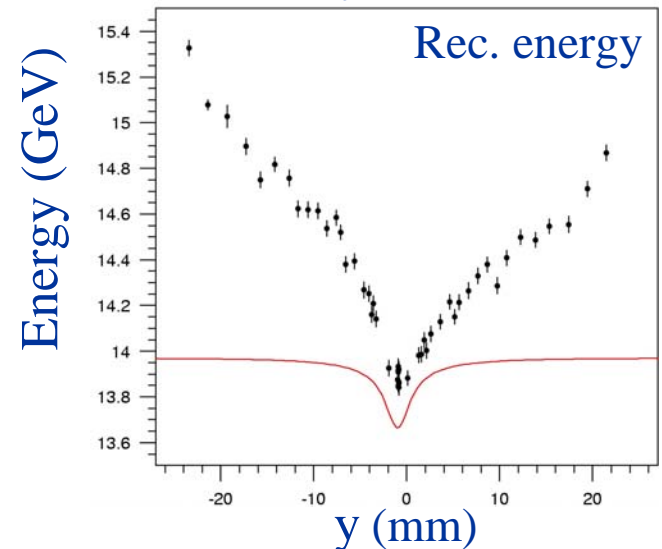
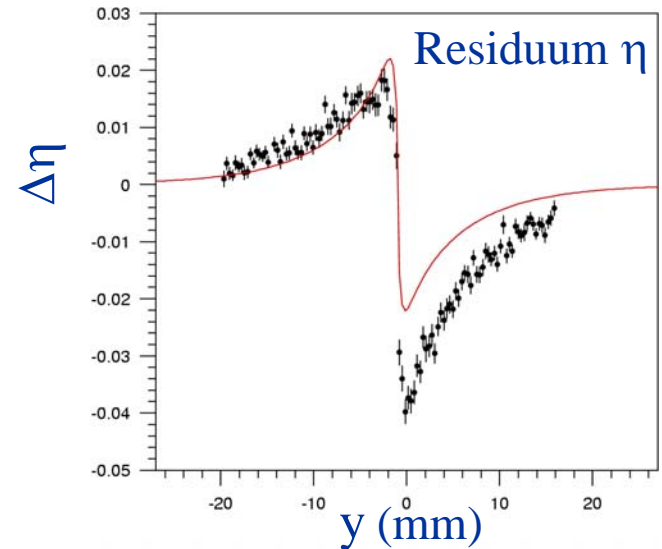

Modelling effects - Quantifying “hardware” and calibration

- All effects induce some changes to η - y and/or energy reconstruction
 - η - y : compare effects with respect to a simple 2-component Ansatz
- Adding induced effects:
 - 3rd shower component
 - Gap with 100% energy loss
 - Linear attenuation
 - Photomultiplier gain difference
 - Lead frames
 - End of scintillators
 - Offset of tungsten absorber
- Note: Energy reconstruction already integrated with gaussian (for later comparison with data)

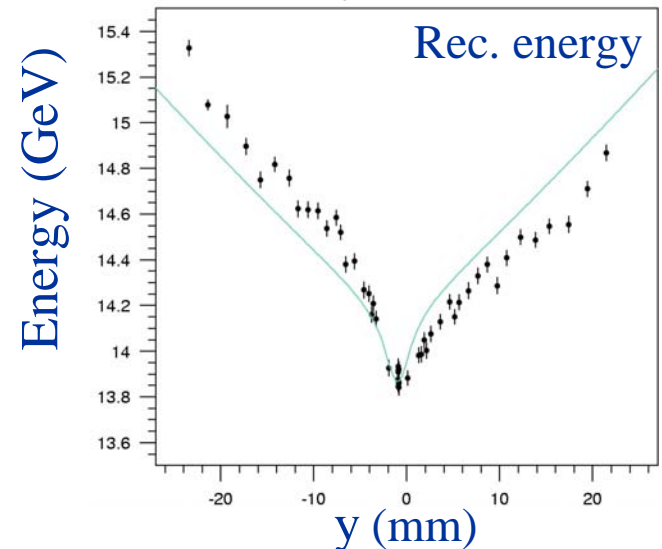
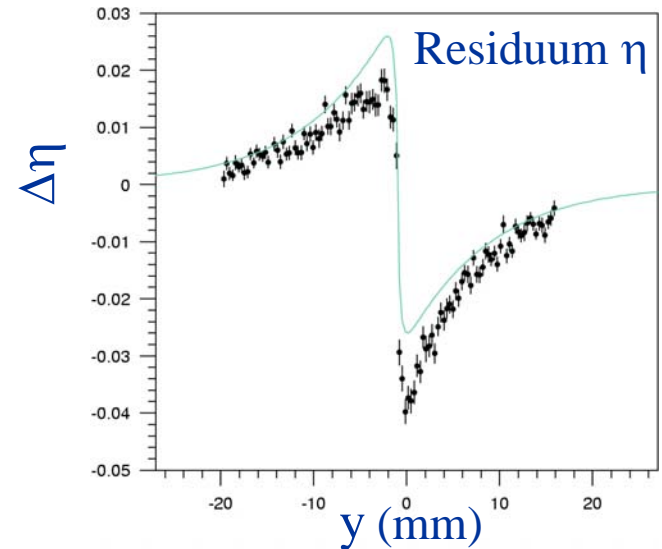

Modelling effects - Quantifying “hardware” and calibration

- All effects induce some changes to η - y and/or energy reconstruction
 - η - y : compare effects with respect to a simple 2-component Ansatz
- Adding induced effects:
 - 3rd shower component
 - Gap with 100% energy loss
 - Linear attenuation
 - Photomultiplier gain difference
 - Lead frames
 - End of scintillators
 - Offset of tungsten absorber
- Note: Energy reconstruction already integrated with gaussian (for later comparison with data)

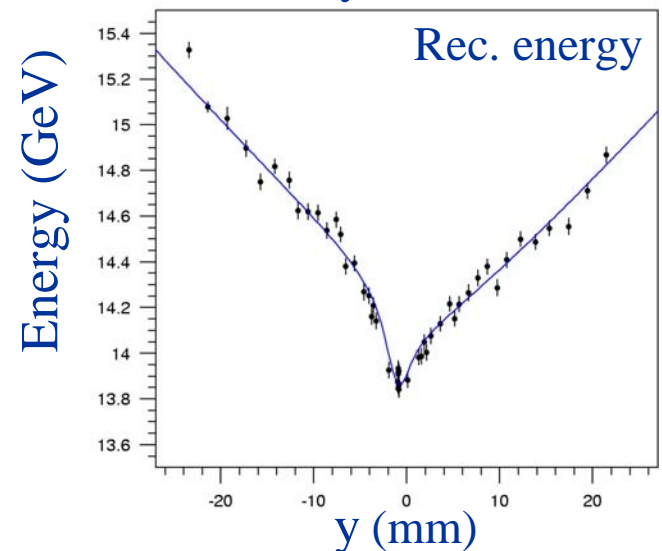
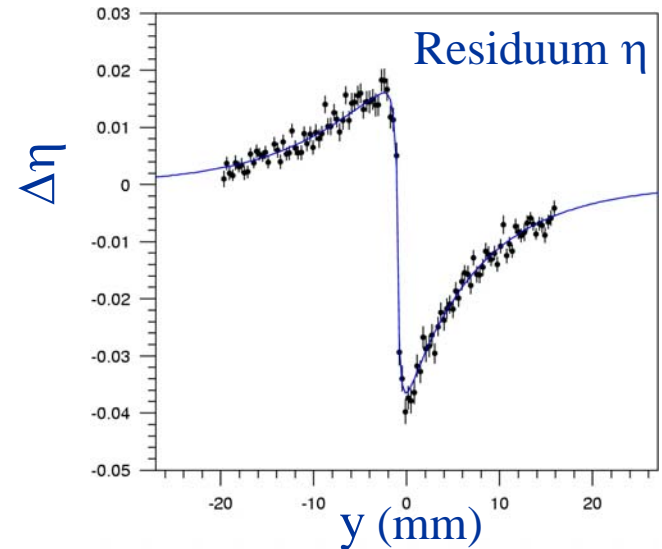

Modelling effects - Quantifying “hardware” and calibration

- All effects induce some changes to η - y and/or energy reconstruction
 - η - y : compare effects with respect to a simple 2-component Ansatz
- Adding induced effects:
 - 3rd shower component
 - Gap with 100% energy loss
 - Linear attenuation
 - Photomultiplier gain difference
 - Lead frames
 - End of scintillators
 - Offset of tungsten absorber
- Note: Energy reconstruction already integrated with gaussian (for later comparison with data)

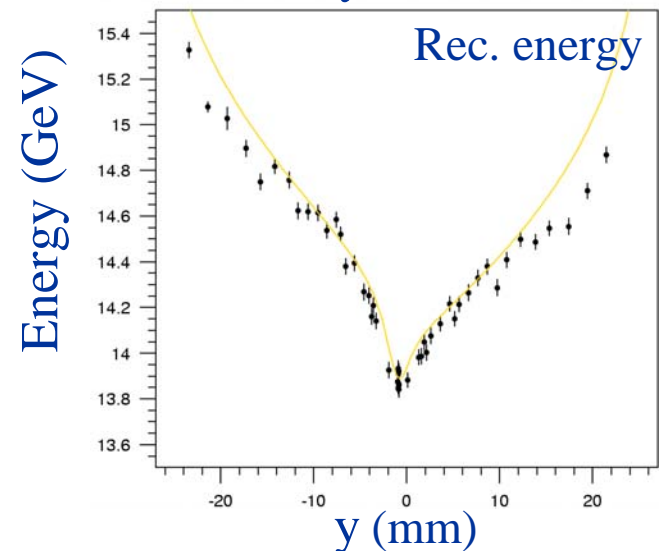
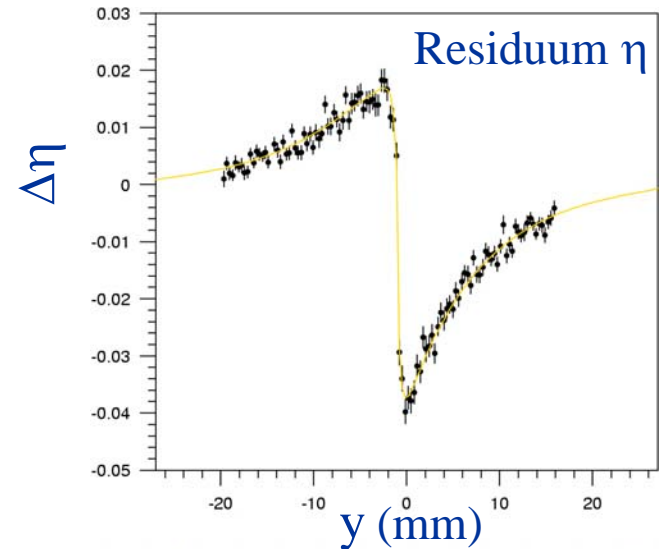

Modelling effects - Quantifying “hardware” and calibration

- All effects induce some changes to η - y and/or energy reconstruction
 - η - y : compare effects with respect to a simple 2-component Ansatz
- Adding induced effects:
 - 3rd shower component
 - Gap with 100% energy loss
 - Linear attenuation
 - Photomultiplier gain difference
 - Lead frames
 - End of scintillators
 - Offset of tungsten absorber
- Note: Energy reconstruction already integrated with gaussian (for later comparison with data)

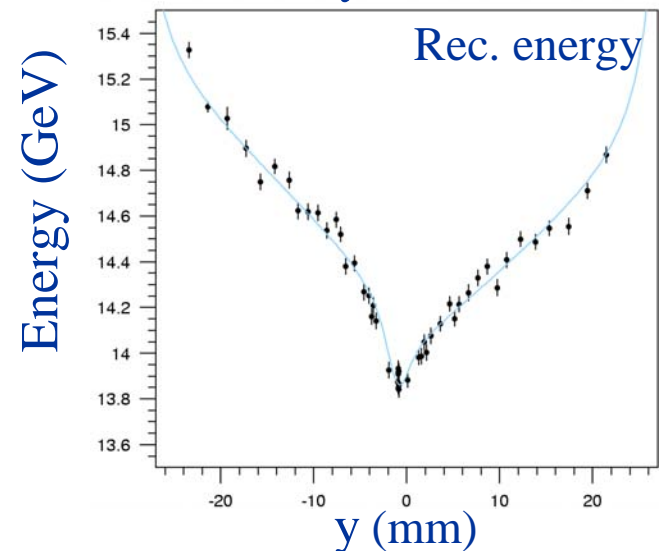
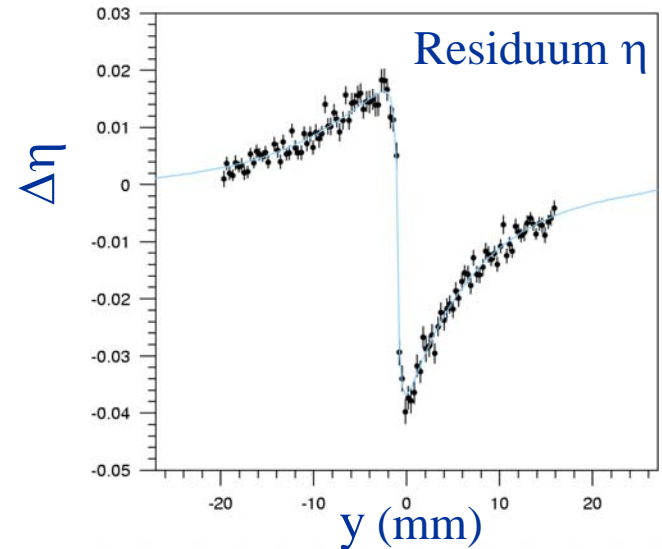

Modelling effects - Quantifying “hardware” and calibration

- All effects induce some changes to η - y and/or energy reconstruction
 - η - y : compare effects with respect to a simple 2-component Ansatz
- Adding induced effects:
 - 3rd shower component
 - Gap with 100% energy loss
 - Linear attenuation
 - Photomultiplier gain difference
 - Lead frames
 - End of scintillators
 - Offset of tungsten absorber
- Note: Energy reconstruction already integrated with gaussian (for later comparison with data)

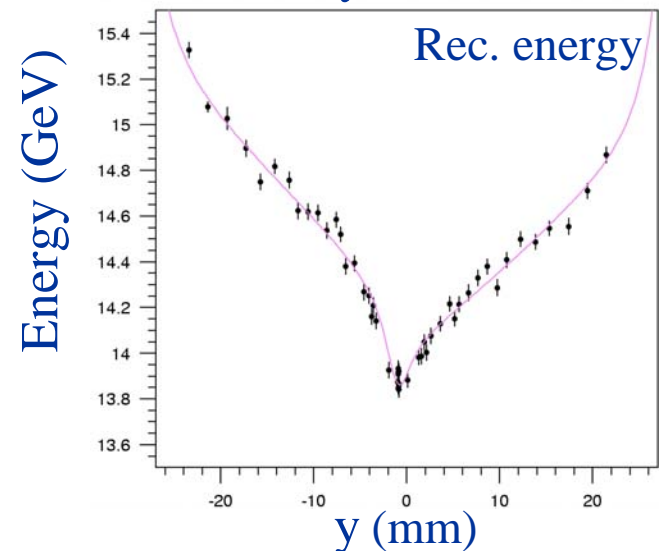
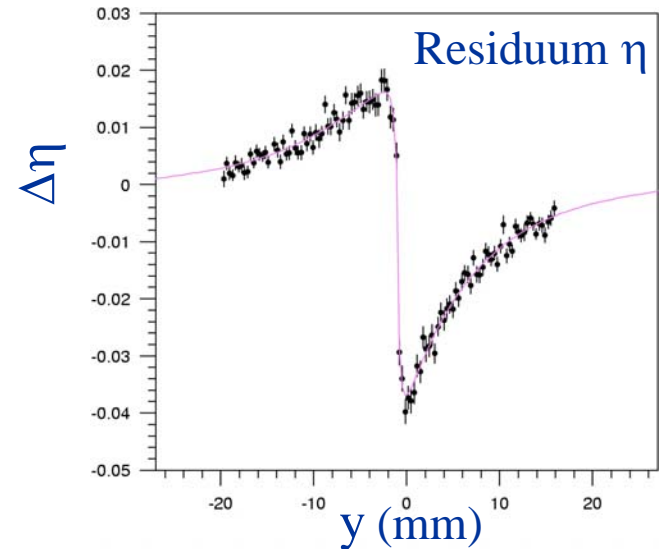

Back to the moving edges - What could induce such a difference?

- Preradiator represents dead material in front of the calorimeter
 - Upon conversion some energy is lost in the preradiator
 - Converted photons have - on average - less energy than nonconverted photons
 - Fluctuations of the energy loss contribute to the energy resolution
 - Converted photons have a worse energy resolution
- Obviously not the case here...
- Energy leaking from the calorimeter
 - ❖ The TPOL calorimeter has finite lateral sizes and is only around $20X_0$ deep
 - Lateral sizes of showers of converted and nonconverted photons are identical
 - Photon showers start - on average - $9/7 X_0$ deeper inside the calorimeter than those of charged particles
 - Photon showers are less contained
 - Longitudinal leakage larger for photons than for converted photons and its fluctuation contributes to the energy resolution
- Looks better in both aspects...

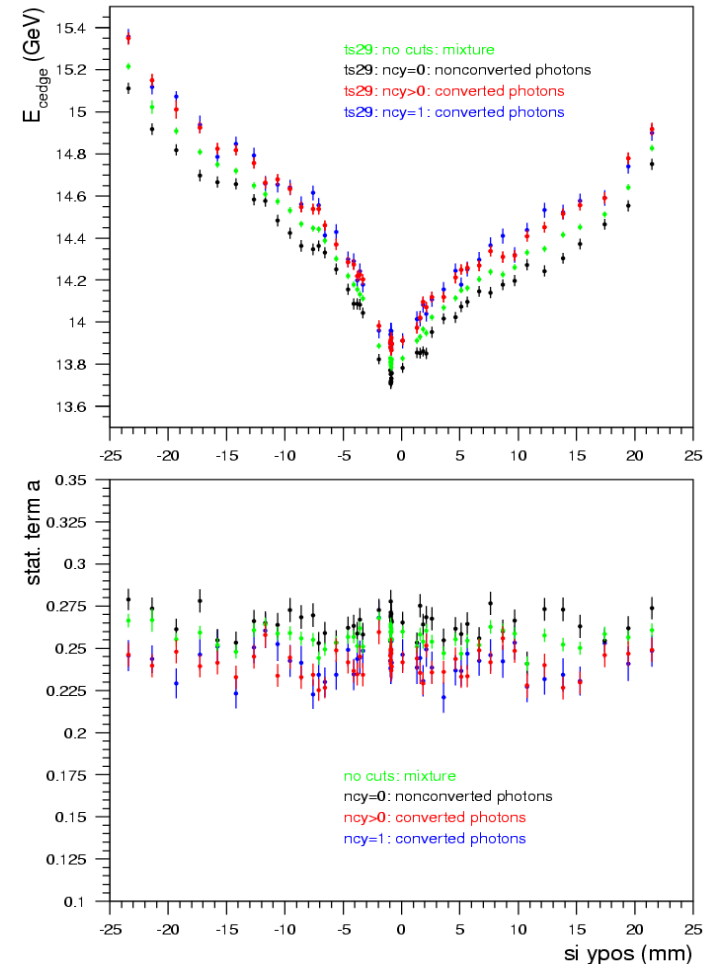

Energy leakage - Illustration with Geant MC

- Energy leaking from the calorimeter
 - Examples of showers in the Geant MC:

Converted photon (9GeV)

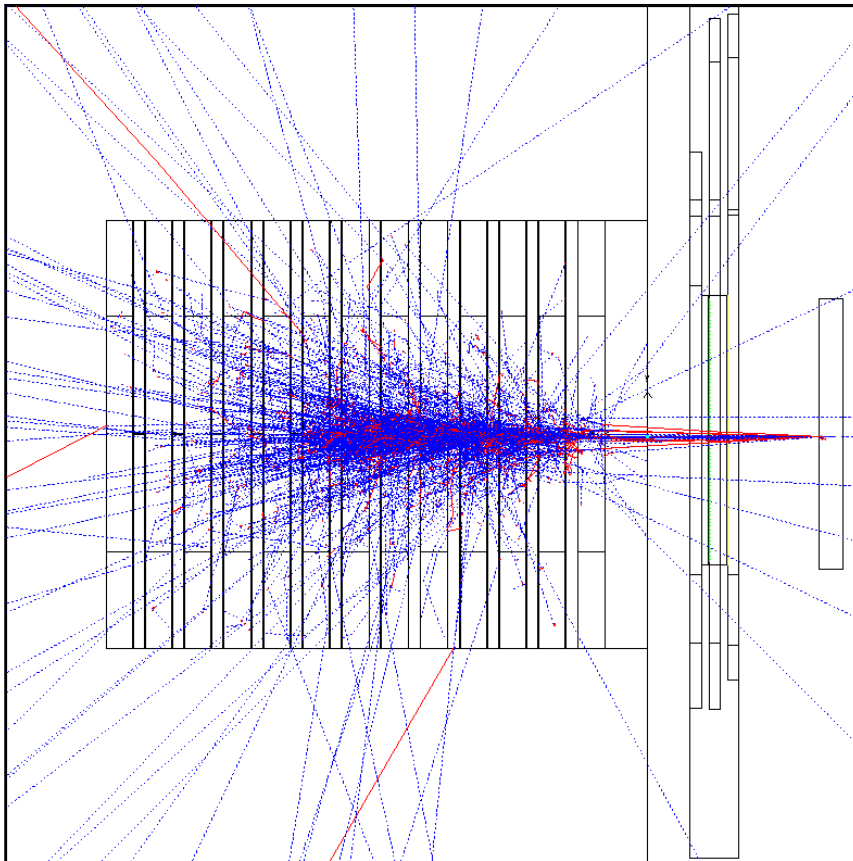

Nonconverted photon (10GeV)

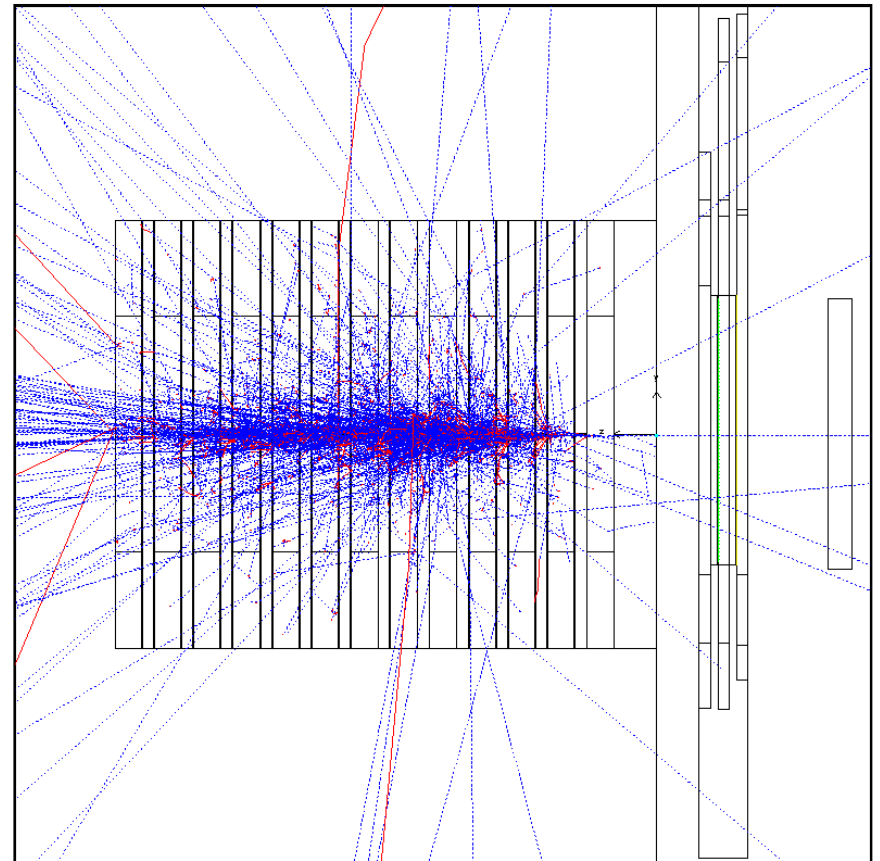

by R. Ciesielski

Energy leakage - In the GEANT Monte Carlo

- Fractional mean energy leaking from the calorimeter
 - Shows $\sim \log(E)$ behaviour, as expected
 - Leveling off at low energies: possibly lateral leakage
 - Nonconverted photons lose more than converted ones!
- Fractional width of energy leaking from the calorimeter
 - Fluctuations are highly non-gaussian
 - Show also $\sim \log(E)$ behaviour
 - Nonconverted photons fluctuate more than converted ones!
 - Contribution to the energy resolution, presumably via a constant term

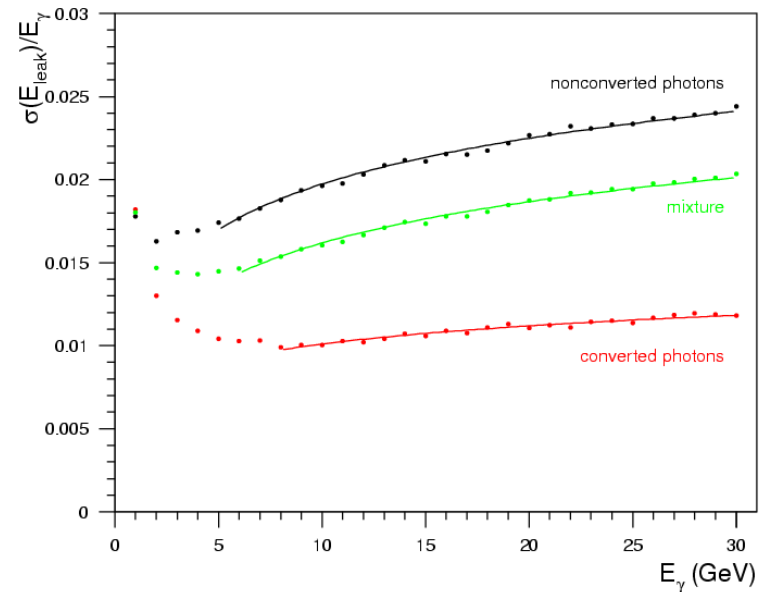
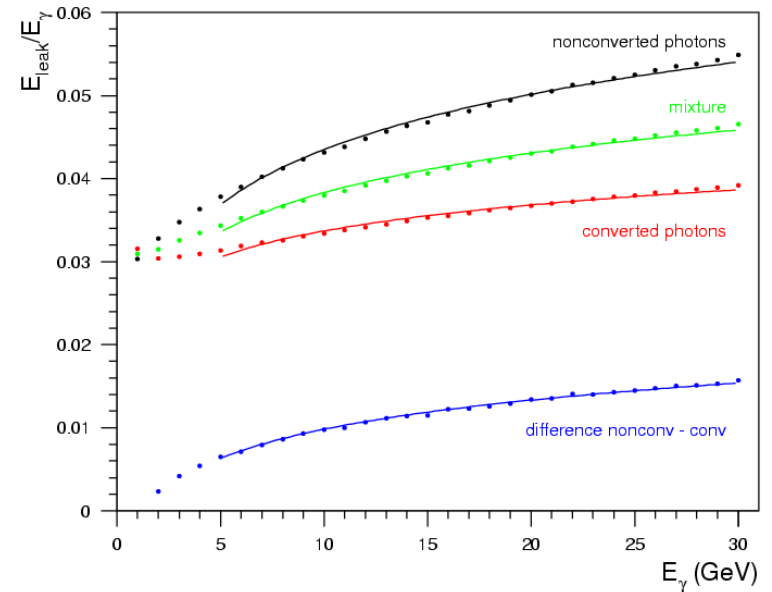

Energy leakage - Can it account for the observed differences?

- Compare silicon data samples with enriched converted and nonconverted photons
- Ratio shows a constant behaviour
 - Overall energy response as function of y same for all types of events
- Measure relative difference
 - Enriched photon sample: Require no clusters at all in x- or y-plane
 - Complete mixture with given conversion fraction of 54%
 - Impurities by converted photons leaving no cluster and efficiency for uncorrelated hits > 0
 - Very low-energetic overlaid Bremsstrahlungs photons can be enriched: they convert with a lower fraction
 - Measured difference can be displayed as a function of one absolute value

➤ Size of difference is very well in agreement with the expectations from the GEANT MC!

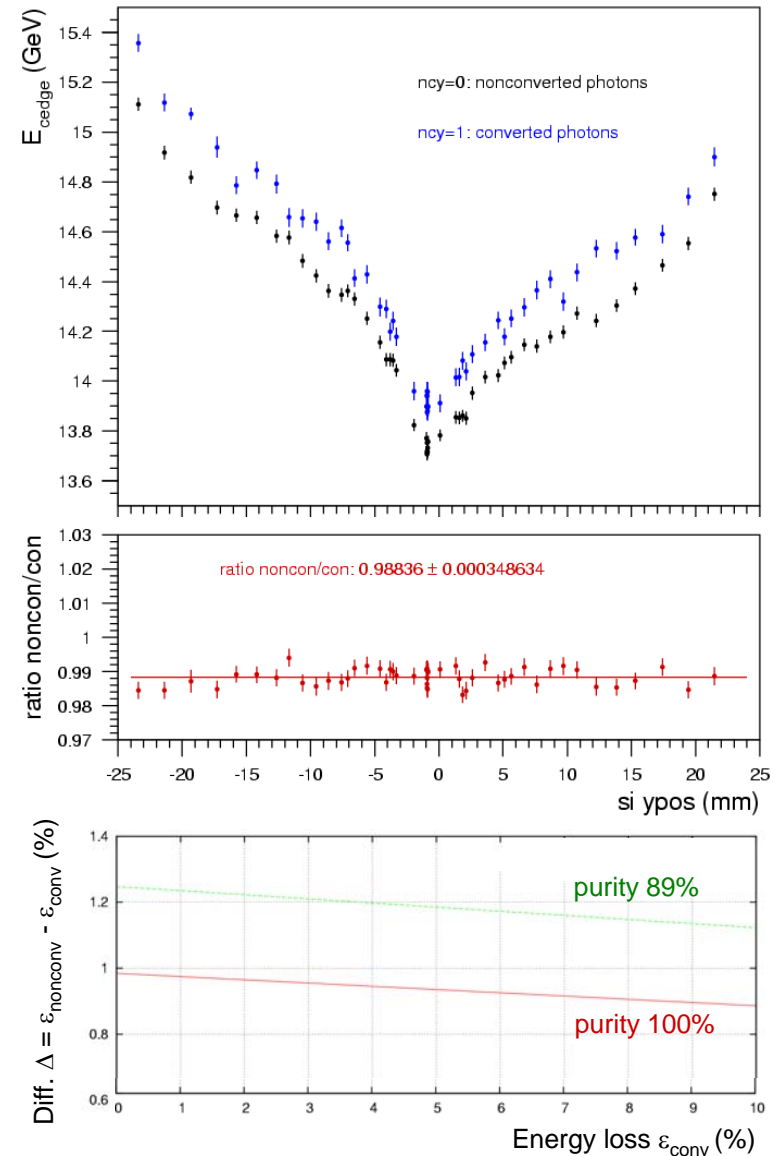

Resolution - In the GEANT Monte Carlo

- Different energy loss still visible after signal processing
 - Not the absolute height, but the differences are interesting: same as observed from leakages
- Resolution differs, photons have a worse resolution than converted ones
- Multiplication by \sqrt{E} reveals there is more than just the statistical term!

- Fitting with a constant term gave best results

$$\left(\frac{\sigma}{E}\right)^2 = \left(\frac{a}{\sqrt{E}}\right)^2 + b^2$$

- Same statistical term: well within 1σ
- Constant terms differ, here:
 - Nonconverted photons 3.14%, converted photons 2.11%
 - Both together 2.70%, higher than expected from pure mixture (2.58%) → it's not only mixing two spectra with different resolutions but also different absolute scales!

➤ Size of the constant terms are equivalent to the observed differences in resolutions of the edge fits!

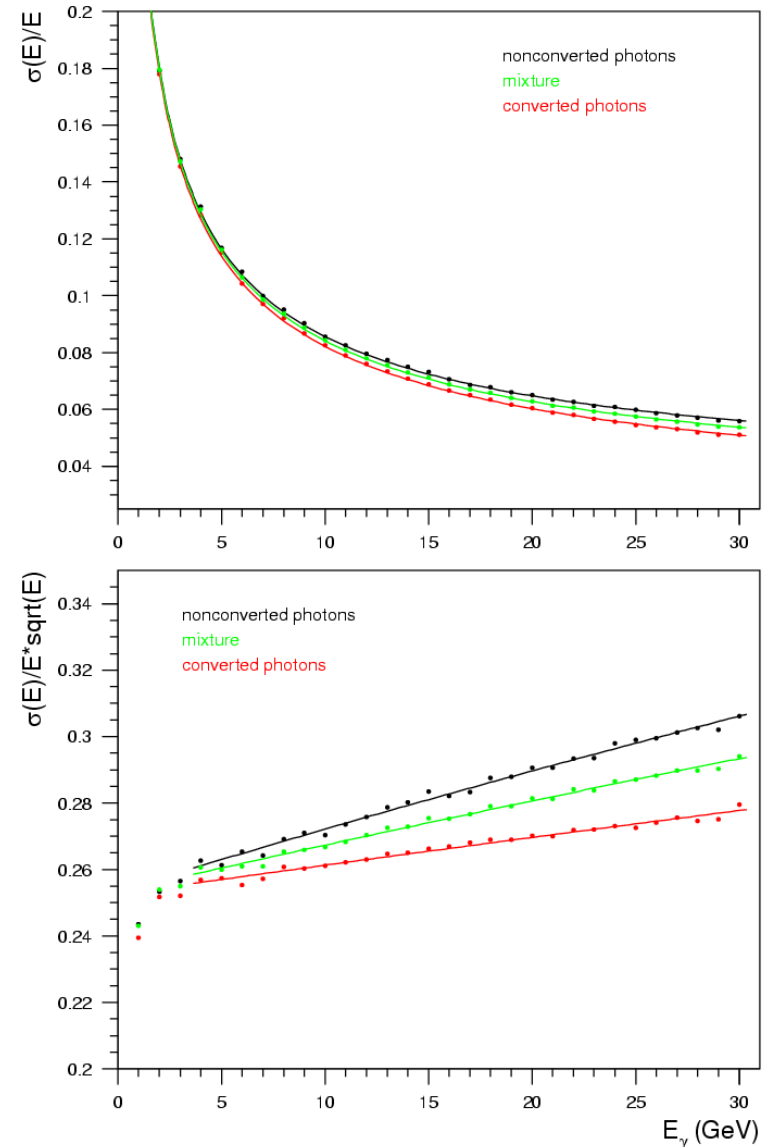

Leakage effects on η - y - given a specific shower modelling

- Two main shower components also related to the longitudinal (as well as lateral) shower development
 - “Short” component is “early”
 - “Long” component is “late”
- Only the “long” component will leak from the calorimeter
 - Changes the fraction of the energy shared between the components
 - η - y : Induced difference is negligible! Also for an Online-Analyzing Power!
 - Expect more differences from a varying “3rd component” → still need extrapolation of “silicon η - y ” to “polarimeter η - y ”
- Impact on attempts modelling the complete spectrum possibly not negligible...

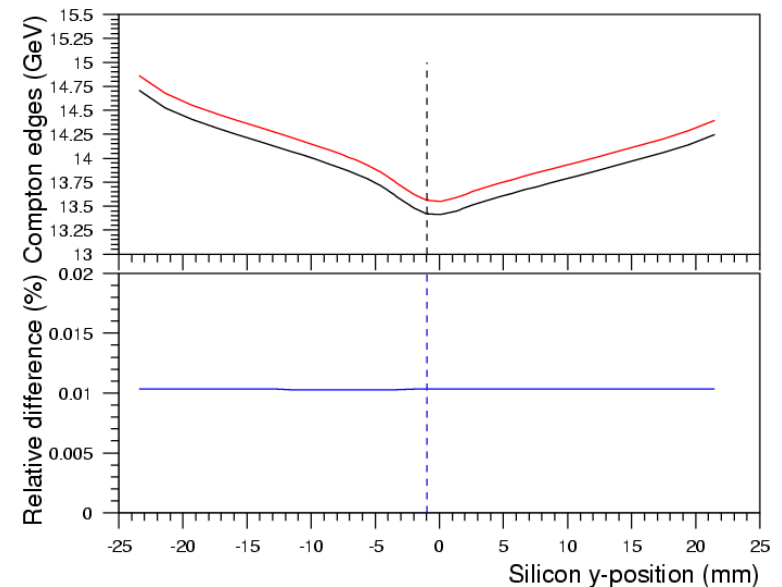
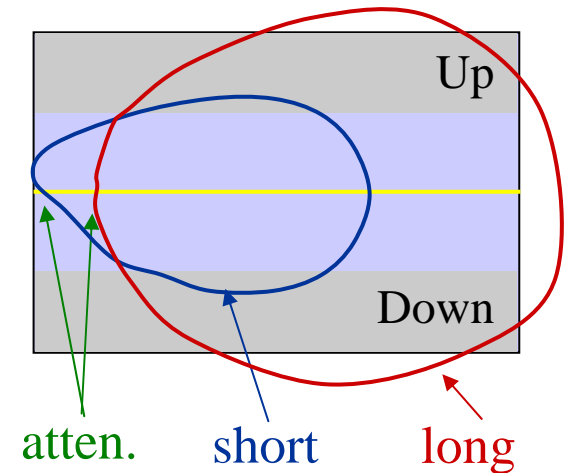

Leakage effects on η - y - given a specific shower modelling

- Two main shower components also related to the longitudinal (as well as lateral) shower development
 - “Short” component is “early”
 - “Long” component is “late”
- Only the “long” component will leak from the calorimeter
 - Changes the fraction of the energy shared between the components
 - η - y : Induced difference is negligible! Also for an Online-Analyzing Power!
 - Expect more differences from a varying “3rd component” → still need extrapolation of “silicon η - y ” to “polarimeter η - y ”
- Impact on attempts modelling the complete spectrum possibly not negligible...

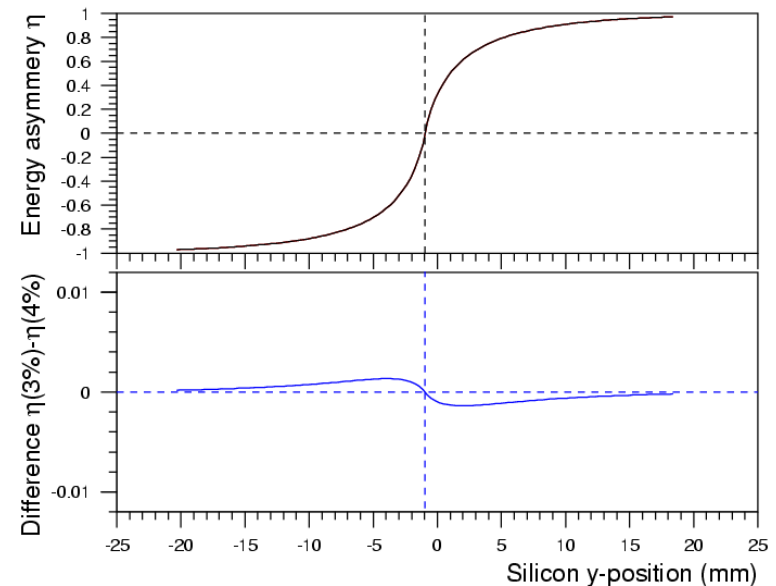
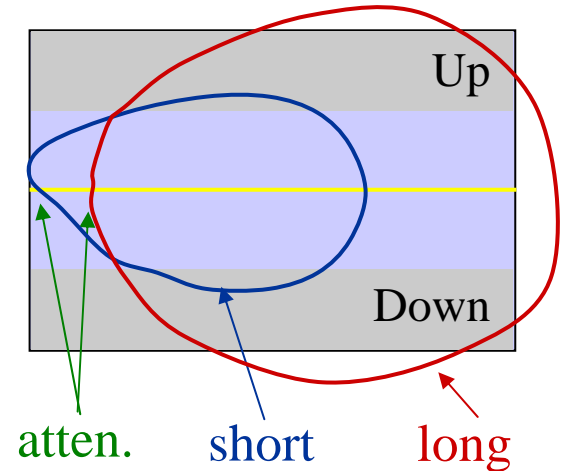

Outlook - Simultaneous fit?

- A simultaneous fit of η -y and energy reconstruction
 - Using all the described effects
 - Residua of η -points to fitted curve improve largely
 - $\chi^2/\text{ndf} \approx 1.2$
 - Within a 95% confidence limit
 - No further systematic deviations can be seen!
- But: Fit has problems with numerical inaccuracies (ends with Minuit status 2) and for all 15 parameters is very slow... Have to look more into this to get it running and check fit evolution...

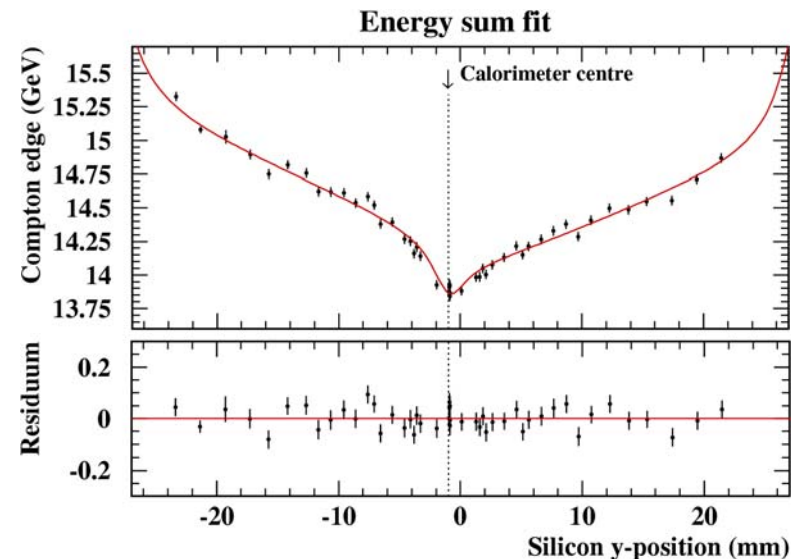
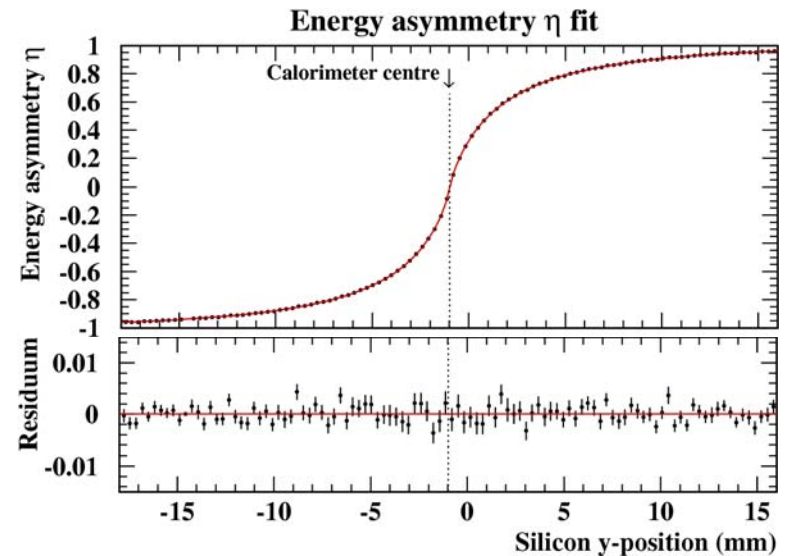

Résumé - Counting ingredients

- Development of an “ η - y transformation” to an “average energy response” describing both

- Energy asymmetry “ η - y transformation”

$$\eta(y_0) = \frac{E_u(y_0) - E_d(y_0)}{E_u(y_0) + E_d(y_0)}$$

- Reconstructed energy

$$E(y_0) = E_u(y_0) + E_d(y_0)$$

- Main contributions to the analytic description:

- Single-particle showers with exponential radial energy distribution

- With 3 components of different shower lengths

- Multi-particle distributions integrate into the single-particle shower

- Yield a change in the inner part of η - y

- (Presumably) digested by the 3rd shower component

- Geometric “hardware” and calibration effects

- Geometric:

- gap between scintillator plates
- light attenuation in scintillator plates
- lead frames changing sampling fraction and Molière Radius
- end of light collection (lateral energy loss)
- energy loss at backplane
- offset of tungsten absorber from symmetry

- Calibrative:

- gain difference

Summary and outlook - What is missing...

- Geometric effects largely overlap with short range shower components
 - Enhance sensitivity in the fit by adding information of energy reconstruction
 - Idea: simultaneous fit for η and reconstructed energy
 - Still needs some care...
- Check fitting performance with a GEANT table scan
 - Sizing of geometric fitting parameters like gap, attenuation, gain difference, ...
 - Difference between converted and nonconverted photons
 - Does the “3rd component“ absorb all differences?
 - Can the “silicon response“ be extrapolated to a “polarimeter response“?
- And then....