

Wakefield streaker diagnostics: wakefield measurements of the corrugated structures at PSI and current status of the diagnostics at European XFEL

Philipp Dijkstal
MXL



Contents

- Introduction to wakefield streaker diagnostics
 - RF streaker diagnostics
 - Analytical wakefield model for corrugated structures
 - Experimental setup at SwissFEL & European XFEL
 - Reconstruction methods
 - Time resolution of the measurement
- Motivation
 - Possible new structures for the European XFEL
 - Improvements of the reconstruction methods?
- Analysis of wakefield measurement from November 2022
 - Goals and summary of data taken
 - Beam characterization with TDS
 - Image saturation at the head of the beam
 - Distance scan – expectation against TDS calibration (WIP)
 - Direct measurement of quadrupole wakefield effects
 - Direct measurement of longitudinal dipole wakefield effects
- Other studies
 - Panofsky-Wenzel correction to model by Bane, Stupakov, Zagorodnov
 - Comparison of my own tracking / reconstruction code to OCELOT (Igor & Sergey)
- Status of wakefield streaker diagnostics at European XFEL
- Future of wakefield streaker diagnostics at European XFEL and summary

Content

- Introduction to wakefield streaker diagnostics
 - RF streaker diagnostics
 - Analytical wakefield model for corrugated structures
 - Experimental setup at SwissFEL & European XFEL
 - Reconstruction methods
 - Time resolution of the measurement

RF streaker diagnostics

- Slice properties (current, emittance, energy spread) are relevant for FELs, but difficult to measure
- Solution: impose a linear beam tilt and measure the transverse properties

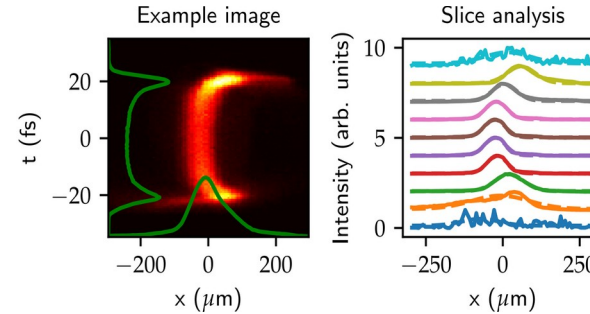
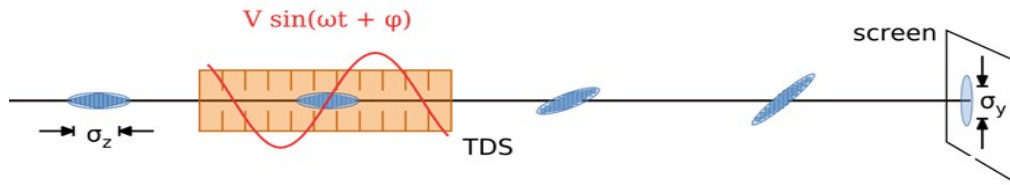

Example slice emittance / beam tilt measurement at SwissFEL

- LCLS colleagues thought of method to indirectly measure the FEL power profile
- Needed: rf deflector after undulator section and screen in dispersive section

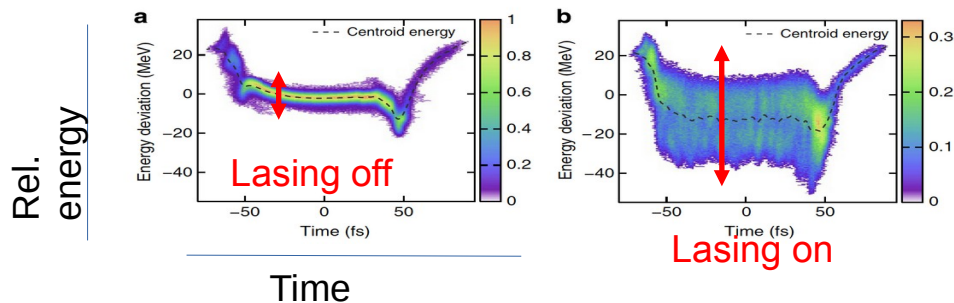

Ding et al., PRST-AB **14**, 120701 (2011)
 Behrens et al., Nat. Commun. **5**, 3762 (2014)

Use wakefield streaking instead

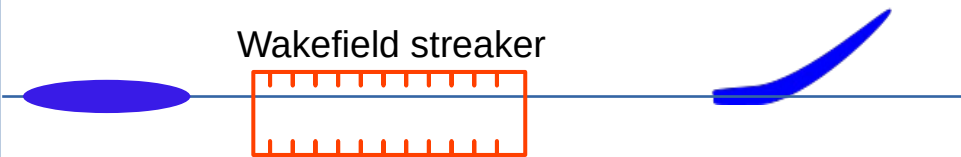

- Advantages: more cost-effective and self-synchronized
- Disadvantage: more difficult measurement
- Dijkstal et al., Phys. Rev. Res. **4**, 013017 (2022)
- Previously done: current profile reconstructions of low energy beams [Seok et al, PRAB **21**, 022801 (2018); Bettoni et al, PRAB **19**, 021304 (2016)]

Analytical wakefield model for corrugated structures

PHYSICAL REVIEW ACCELERATORS AND BEAMS **19**, 084401 (2016)

Analytical formulas for short bunch wakes in a flat dechirper

Karl Bane and Gennady Stupakov

SLAC National Accelerator Laboratory, 2575 Sand Hill Road, Menlo Park, California 94025, USA

Igor Zagorodnov

Deutsches Elektronen-Synchrotron, Notkestrasse 85, 22603 Hamburg, Germany

(Received 8 April 2016; published 4 August 2016)

- Analytical expression for Greene's function
- Here assuming that streaking happens in horizontal plane (x)
- Taylor expansion in position of probe particle (x_1), results in dipole and quadrupole wakefield terms: w_d and w_q .
- Dipole term is the streaking term, quadrupole term is the defocusing term which also acts on the vertical plane (y).
- Strength depends on distance from plate d.

$$w_x(t, \bar{x}_0, x_1) = w_d(t, x_0) + w_q(t, \bar{x}_0) \cdot (x_1 - \bar{x}_0)$$

$$w_y(t, \bar{x}_0, \bar{y}_0, y_1) = -w_q(t, \bar{x}_0) \cdot (y_1 - \bar{y}_0)$$

$$w_d(t, \bar{x}_0; d) \propto d^{-3} = (a - |\bar{x}_0|)^{-3}$$

$$w_q(t, \bar{x}_0; d) \propto d^{-4} = (a - |\bar{x}_0|)^{-4}$$

$$W = \int_{-\infty}^{\infty} dt' I(t') w(t - t')$$

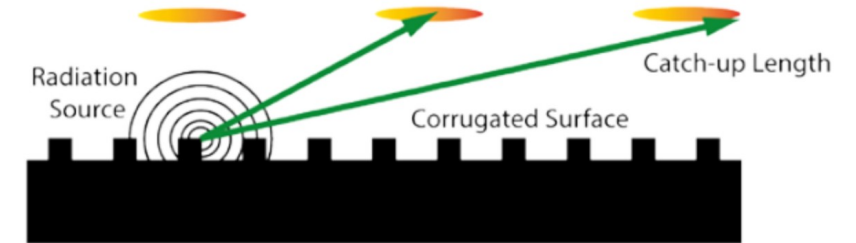
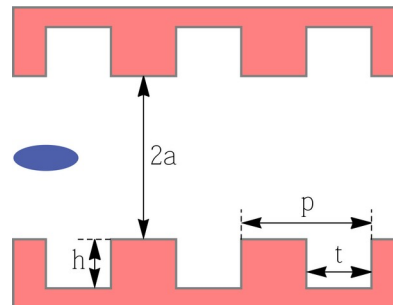

Example from SwissFEL

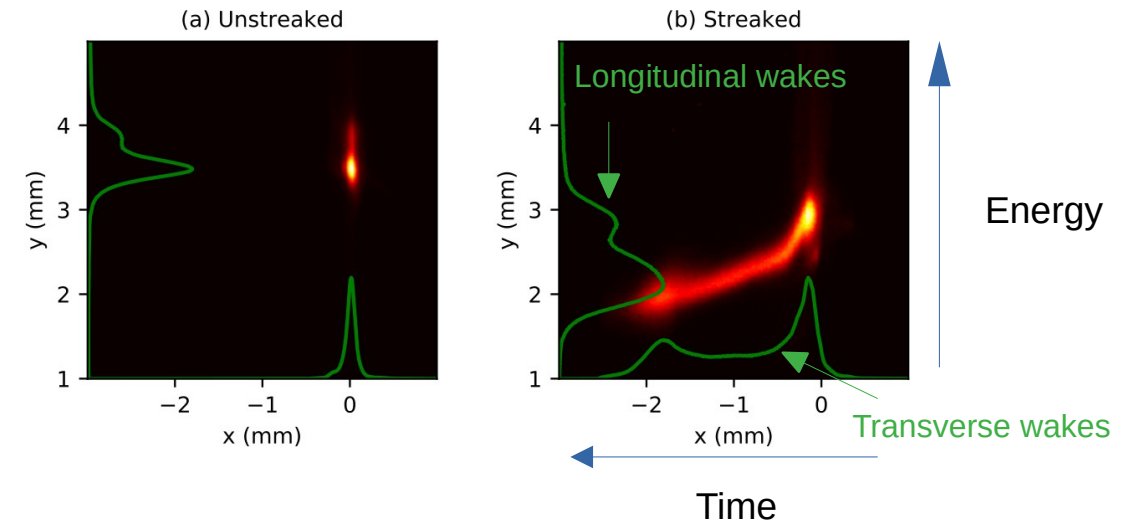

Experimental setups at SwissFEL & the European XFEL

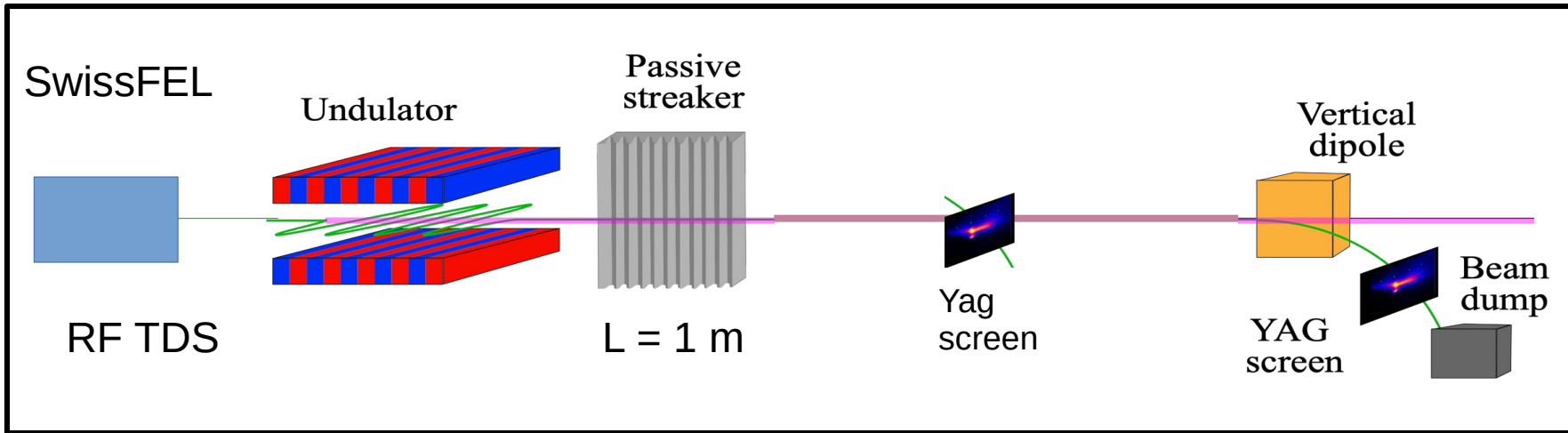

- Double-sided structure with both plates movable.
- High precision motors.
- $L = 1 \text{ m}$
- Dispersive screen available
- High resolution (2 fs) RF TDS available .

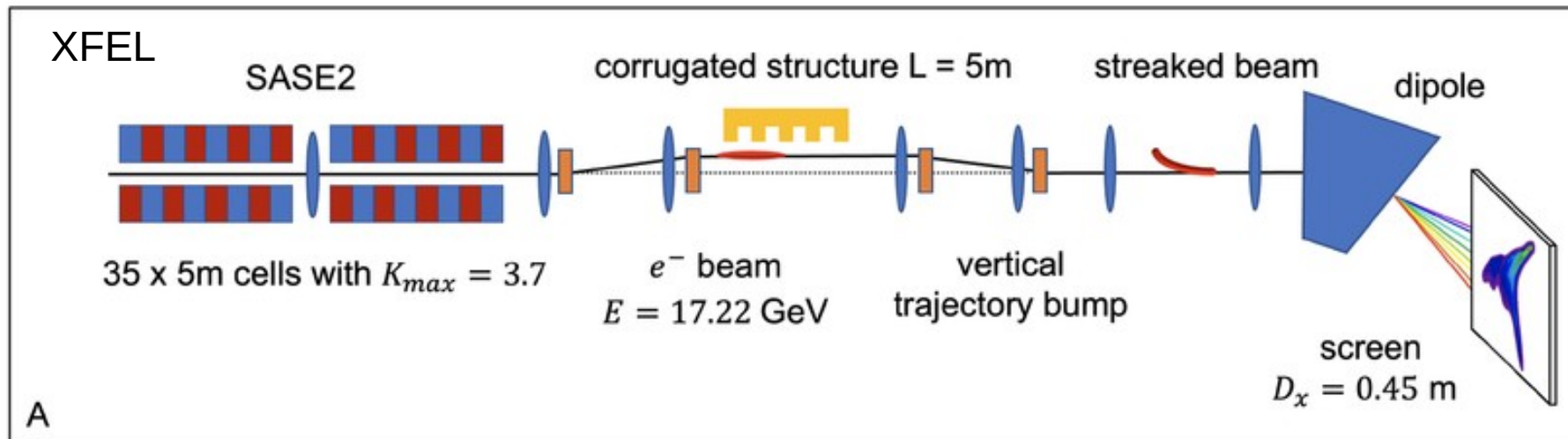

- Single-sided, non-movable structure
- Problems with orbit bump so far.
- $L = 5 \text{ m}$
- Dispersive screen unavailable
- RF TDS in principle is also available, but practically is rarely used. Resolution is closer to 10 fs from what I have heard.

Current profile reconstruction

Assumptions and simplifications

- Assume charge and transport matrix between passive streaker and screen are known
- Assume monochromatic and untilted beam
- Ignore quadrupole wakefields, information from unstriaked coordinate (y or δ)
- Use Karl Bane et al.'s wakefield model

3 main algorithms

- Inner loop with Input: distance d , Gaussian σ , measurement $\rho(x)$; and Output $I(t; d, \sigma)$
- Middle loop with Input: $d, \rho(x)$ and output $I(t; d)$
- Outer loop with Input: $\rho(x)$ from measurements at different d . Absolute differences between d are known. Output: calibration which yields all d

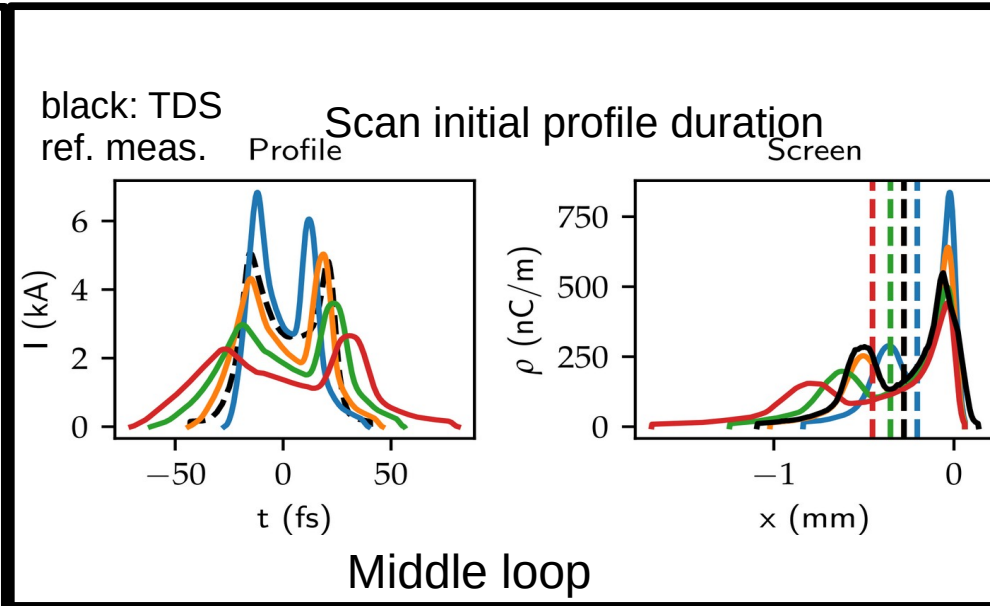
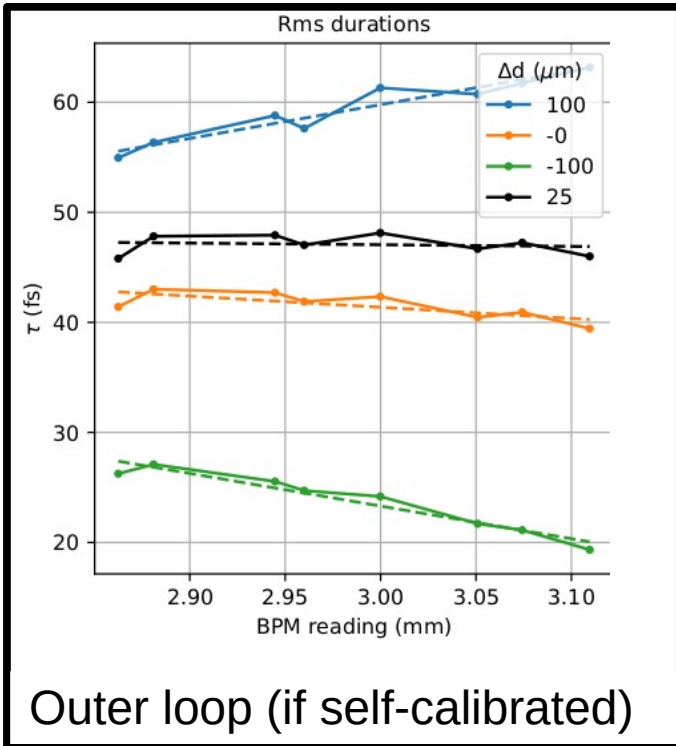

- Use only dipole term. Quadrupole term is error term.
- Do not use longitudinal wakefield model.

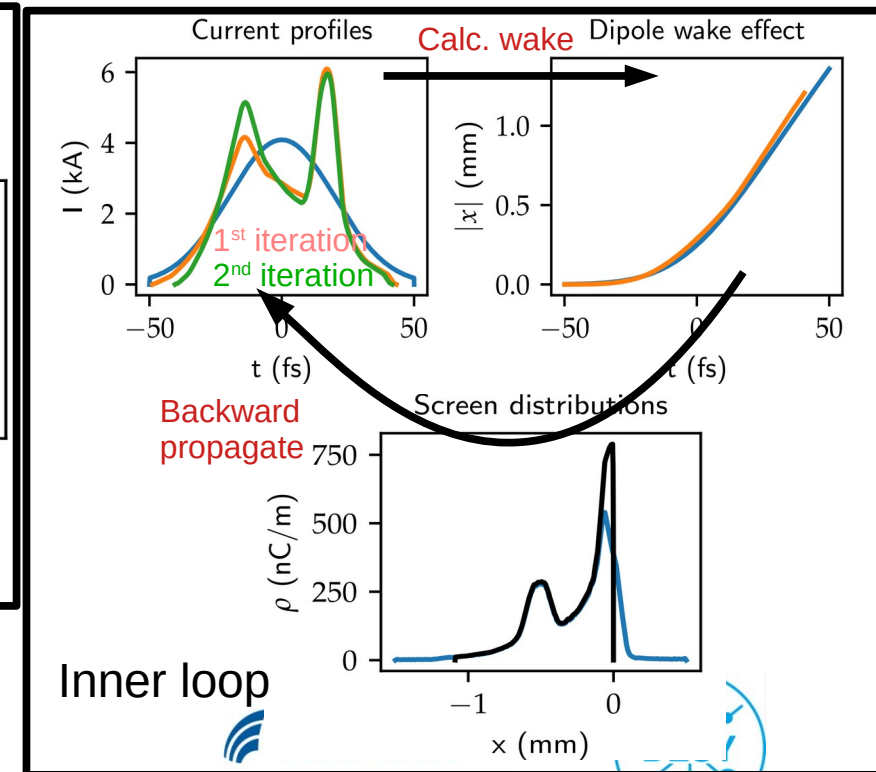

Time resolution

- Time resolution of wakefield streaker measurements was first studied by Craievich and Lutman

Nuclear Instruments and Methods in Physics Research A 865 (2017) 55–59

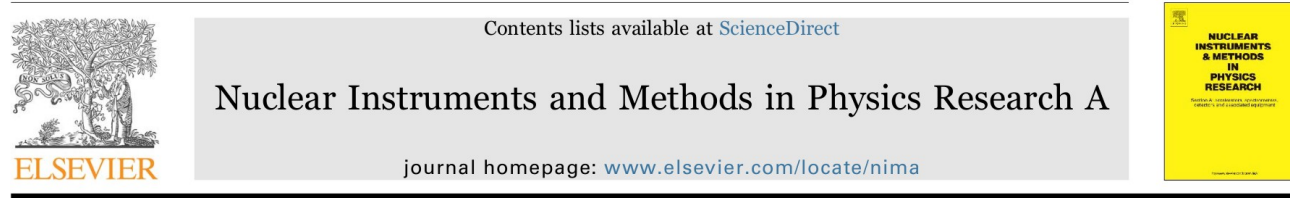

Effects of the quadrupole wakefields in a passive streaker

Paolo Craievich^{a,*}, Alberto A. Lutman^b

^a Paul Scherrer Institut, 5232 Villigen, Switzerland

^b SLAC National Accelerator Laboratory, Menlo Park, CA 94025, USA



- Explanation for resolution: we do not measure t , but x .
- At the same x , particles from different t arrive.
- Drivers of resolution are screen resolution, natural beam size, and quadrupole wakefield

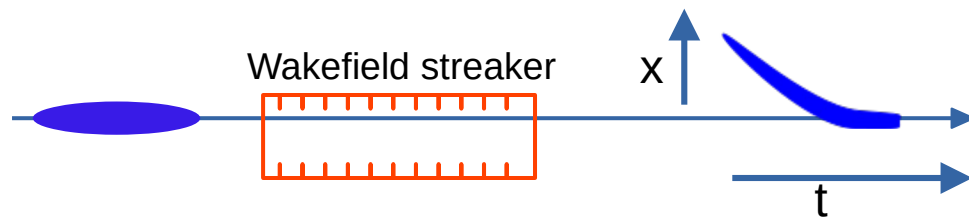

European XFEL

Example calculation for XFEL postSA2

$d = 500 \mu\text{m}; \sigma_R = 8 \mu\text{m}$

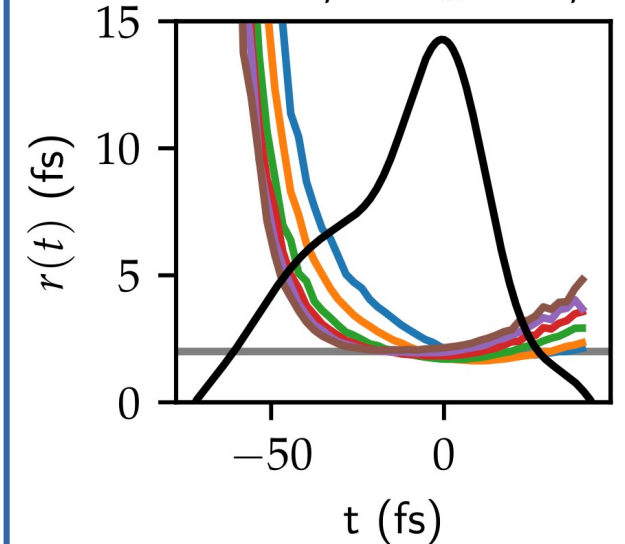

$$r(t) = \frac{\sigma_{\text{eff}}(t)}{|dx(t)/dt|} \quad \sigma_{\text{eff}}^2(t) = \sigma_R^2 + \sigma^2(t)$$

$$\begin{aligned} \sigma^2 &= \epsilon_g \left[(R_{11} + R_{12}\tilde{W}_q)^2 \beta_0 - 2R_{12}(R_{11} + R_{12}\tilde{W}_q)\alpha_0 + R_{12}^2 \gamma_0 \right] \\ &= \epsilon_g \left(R_{12}^2 \tilde{W}_q^2 \beta_0 + 2R_{12}\tilde{W}_q(R_{11}\beta_0 - R_{12}\alpha_0) + \frac{(R_{11}\beta_0 - R_{12}\alpha_0)^2}{\beta_0} + \frac{R_{12}^2}{\beta_0} \right) \end{aligned}$$

Same expression for σ in non-streaking plane, except that W_q is replaced by $-W_q$.

Content

- Motivation for wakefield studies
 - How good is the wakefield model?
 - How well is the effect described by expansion into dipole and quadrupole terms?
 - Possible new structures for the European XFEL. Something to learn?
 - Improvements of the reconstruction methods, taking higher order modes into account?

Motivation 1: More corrugated structures for diagnostics and beam shaping at XFEL?

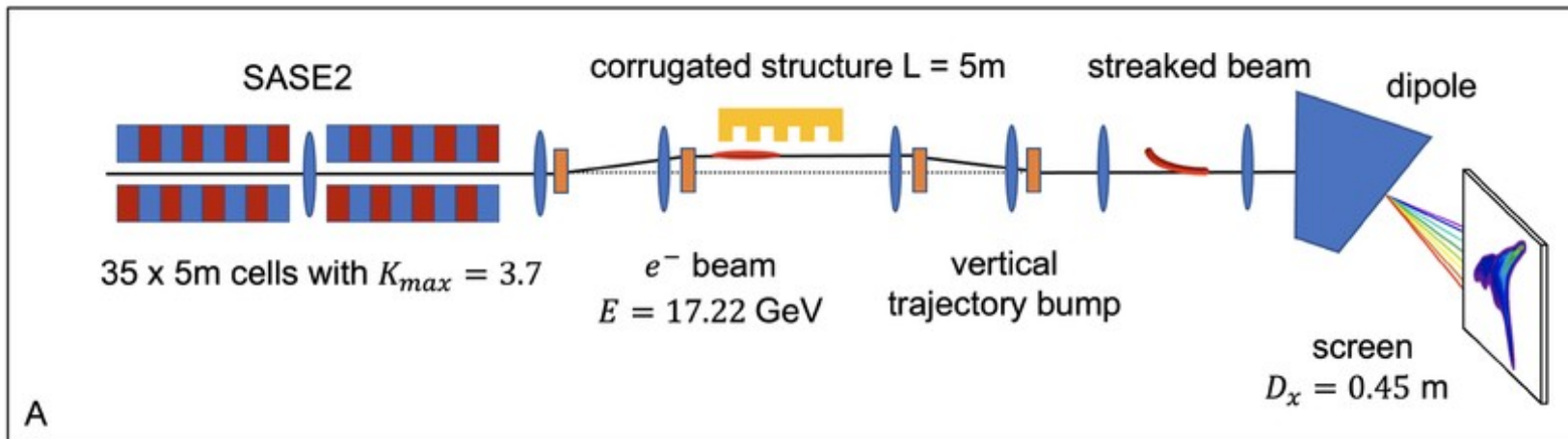
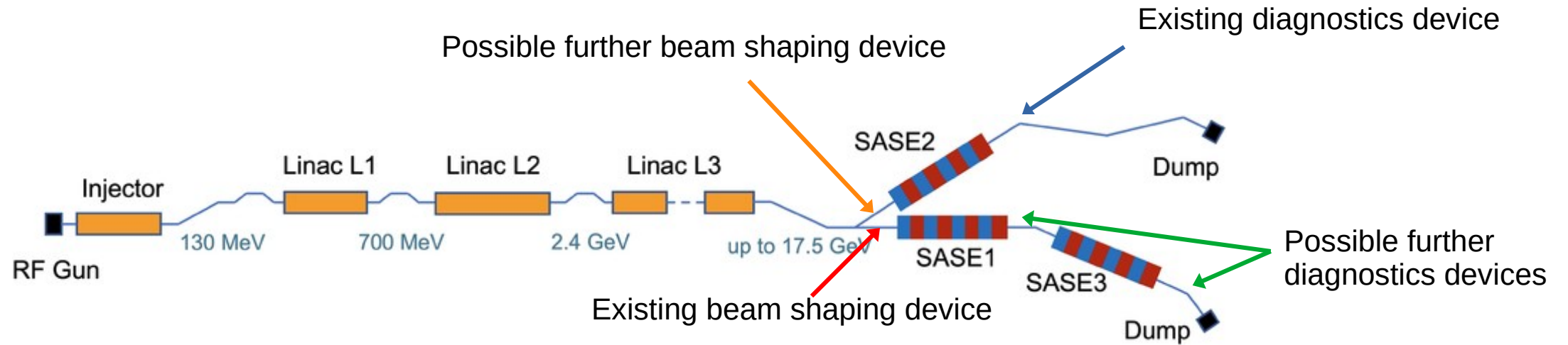

Good reason to study the wakefields now before decisions on new structures are taken.

Motivation 2: Ryan Roussel from the SLAC ML team reached out to me

2

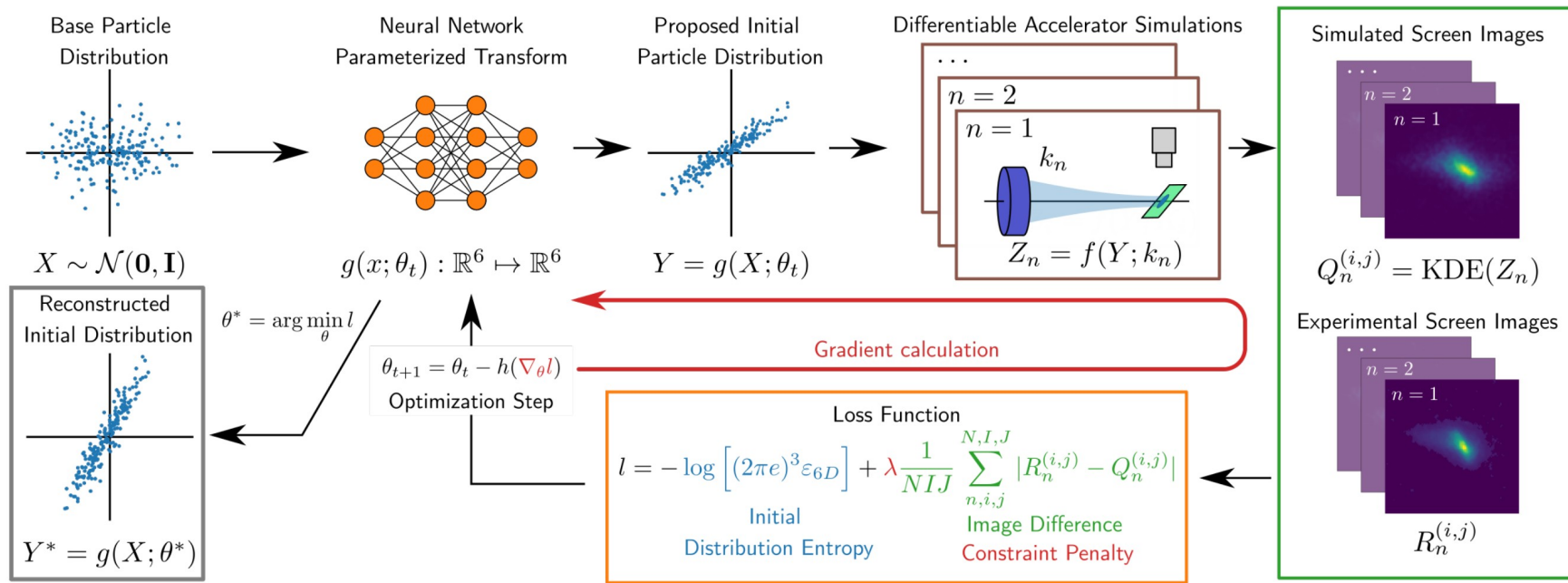

FIG. 1. Description of our approach for reconstructing phase space beam distributions. First, a 6D base distribution is transformed via neural network, parameterized by θ_t , into a proposed initial distribution. This distribution is then transported through a differentiable accelerator simulation of the tomographic beamline. The quadrupole is scanned to produce a series of images on the screen, both in simulation and on the operating accelerator. The images produced both from the simulation $Q_n^{(i,j)}$ and the accelerator $R_n^{(i,j)}$ are then compared with a custom loss function, which attempts to maximize the entropy of the proposal distribution, constrained on accurately reproducing experimental measurements. This loss function is then used to update the neural network parameters $\theta_t \rightarrow \theta_{t+1}$ via gradient descent. The neural network transformation that minimizes the loss function generates the beam distribution that has the highest likelihood of matching the real initial beam distribution.

- Published last week in <https://doi.org/10.1103/PhysRevLett.130.145001>
- Good wakefield model needed in order to apply this technique to passive streaker diagnostics
- Would use all information, not only the dipole wakefield term.
- Would directly include beam tilt and energy profile measurement.
- I could use the same data set that I will present in the upcoming slides for this technique.

Contents

- Analysis of wakefield measurement from November 2022
 - Goals and summary of data taken
 - Beam characterization with TDS
 - Image saturation at the head of the beam
 - Distance scan – expectation against TDS calibration (WIP)
 - Direct measurement of quadrupole wakefield effects
 - Direct measurement of longitudinal dipole wakefield effects

PSI double-sided, movable corrugated structures

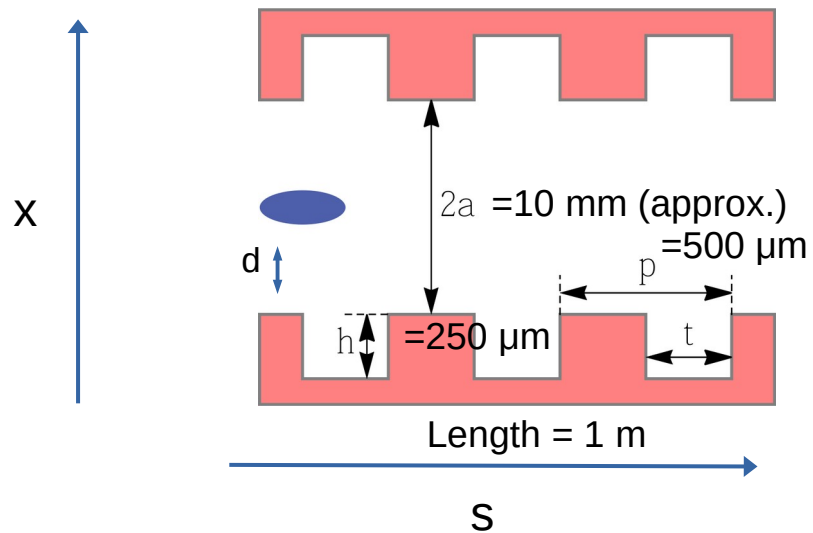

Corrugations are only half as deep as for SLAC / XFEL structures
 Both plates are movable with high precision. Angle cannot be adjusted.

Corrugation depth h
 Corrugation period p
 Corrugation length t
 Vertical plate width (not shown) = 40 mm

Up to 3 corrugations next to each other.
 Can be changed manually.

Design by P. Heimgartner

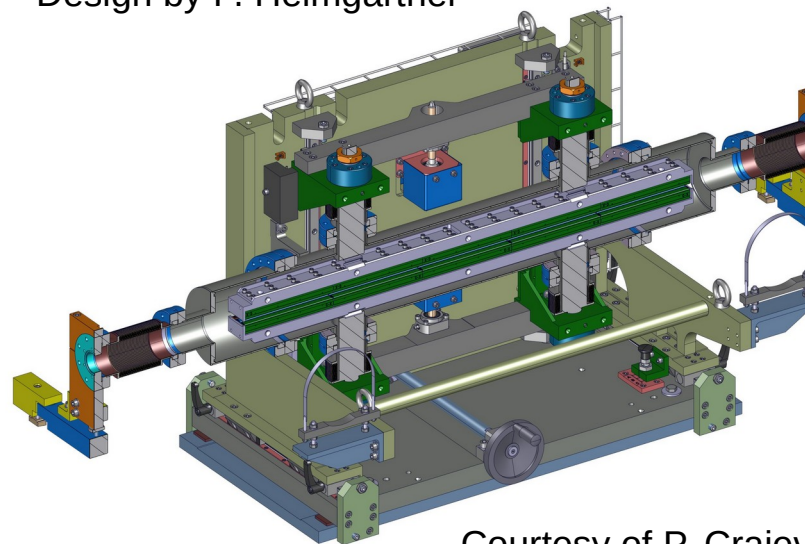
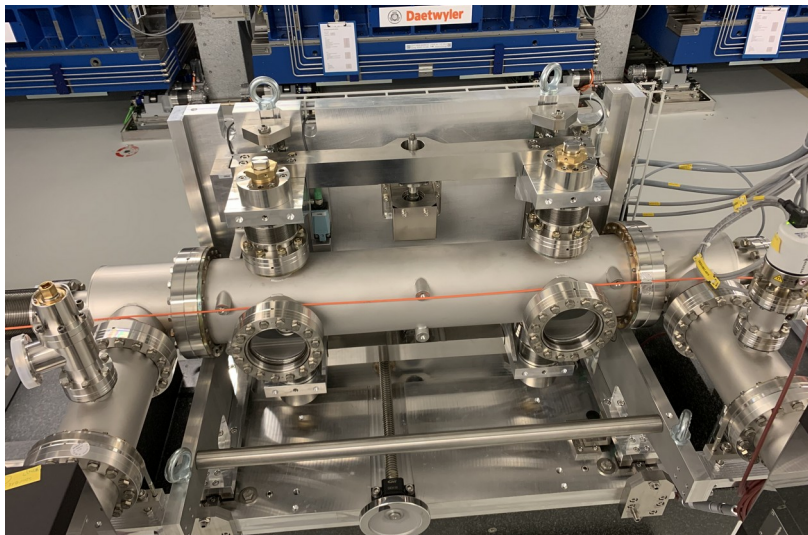

Courtesy of P. Craievich

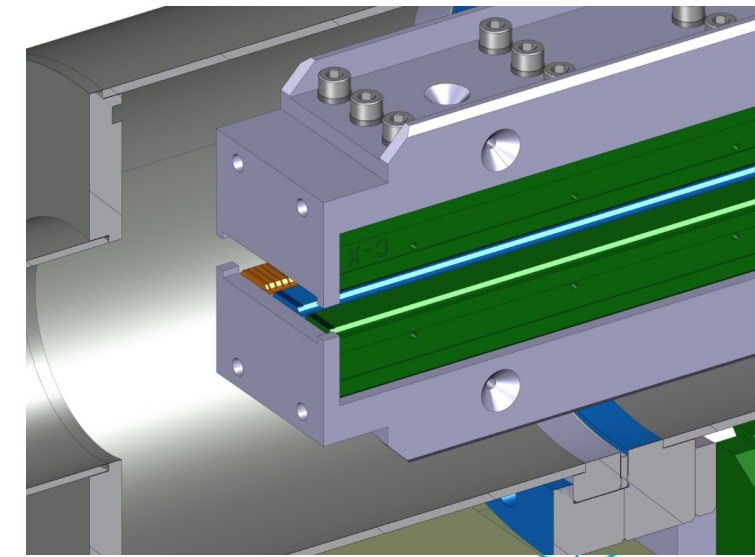

Goals of the experiment and the data that was taken

- Performed by Philipp Dijkstal, Eduard Prat, Alexander Malyzhenkov, Paolo Craievich
- The original idea was to explore the output of our diagnostics tool (using Karl and Gennady's model) under variation of the incoming beam optics
- We wanted to compare these measurements against the resolution function as obtained by P. Craievich and A. Lutman: NIM A **865**, 55 (2017), <https://doi.org/10.1016/j.nima.2016.10.010>
- The beam was characterized with the rf deflector.
- Varied parameters.
 - Incoming beam optics were varied. In total 7 6 optics.
 - Structure plate position. First one, then the other corrugated plate was moved close to the beam path. In total 6 measurement points per beam optics and per streaking direction, plus one central position.
 - We took 20 images per measurement point, from both the dispersive screen in the dump, and from the screen before the dump dipole.
 - In total $6 \cdot 13 \cdot 2 \cdot 20 = 3120$ images

Beam characterization

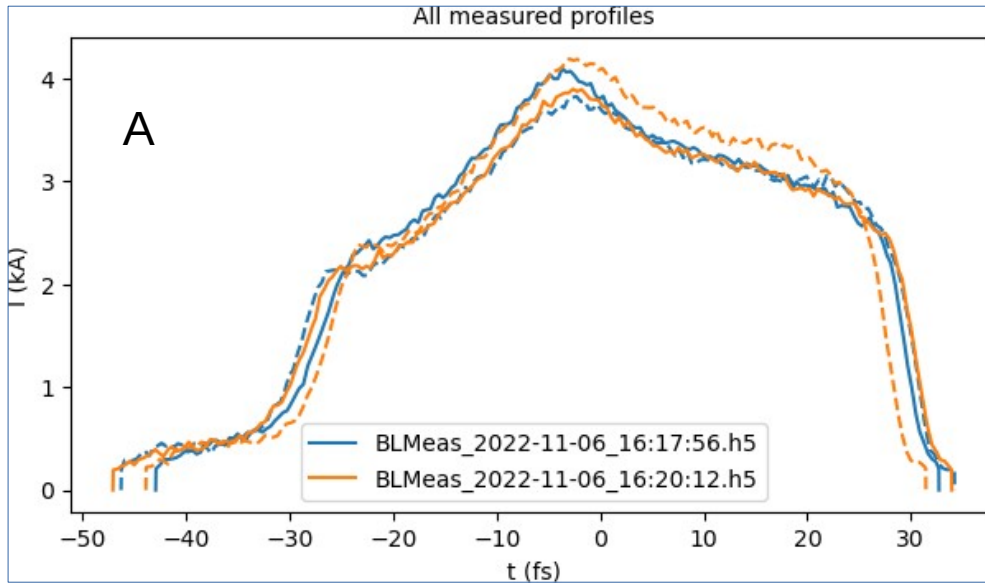

A) 2 successive rf deflector current profile measurements (blue, orange). FWHM around 60 fs. The current profile was not varied. From each, the current profile from two different zero-crossings (solid, dashed) are shown. They differ only by little, indicating only very small vertical beam tilts.

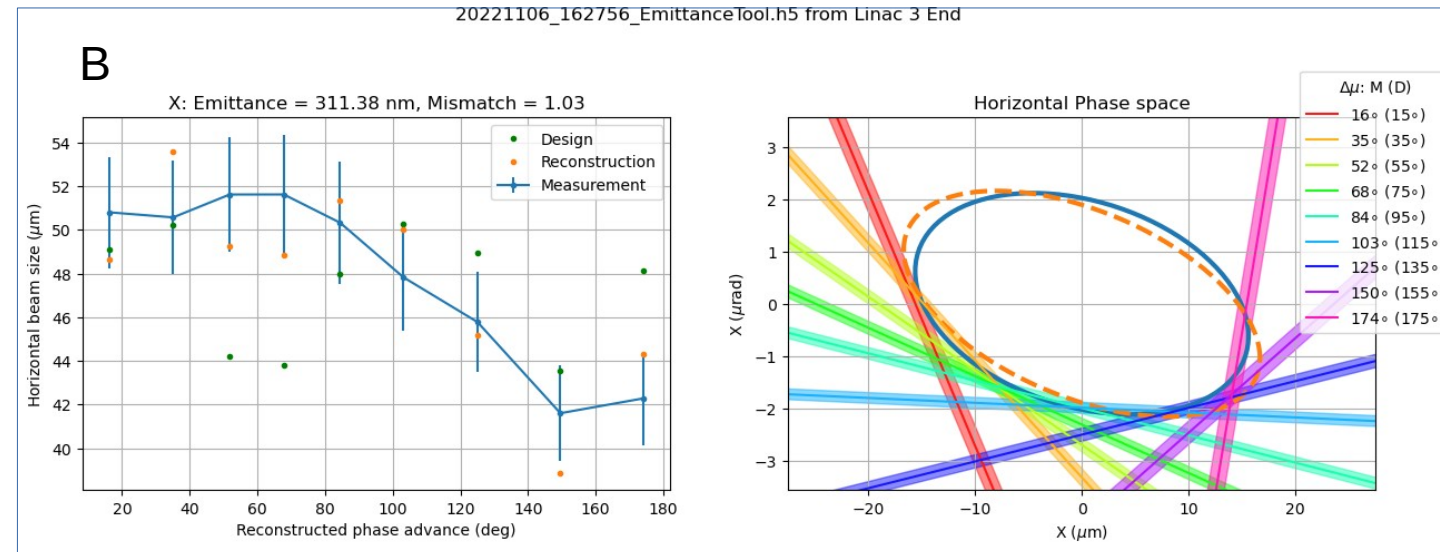

B) Horizontal slice emittance measurement showing good matching to design optics Later: forward propagate measured optics to passive streaker location using saved quadrupole and undulator magnetic settings

C) Slice misplacement (beam tilt measurement). Showing small slice displacements. See my upcoming talk at the FEL R&D meeting on 3rd of May.

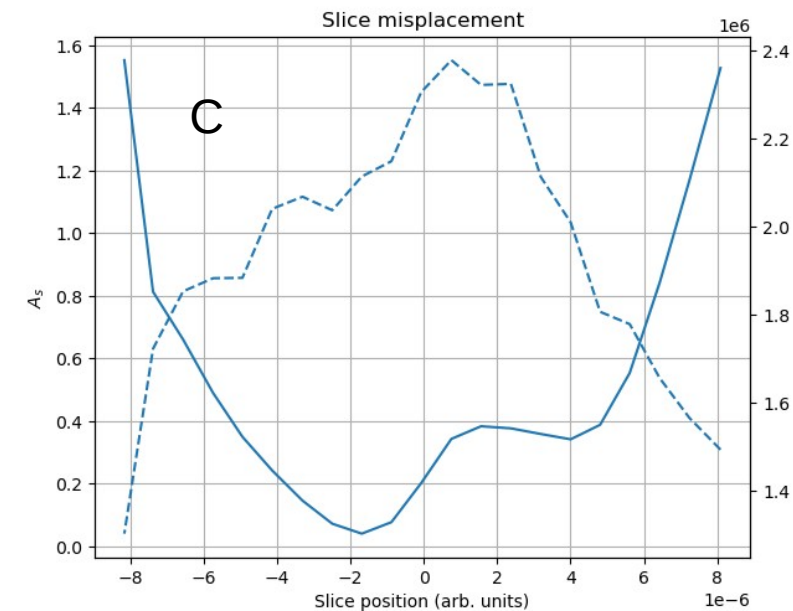

Big advantage of having TDS readily available!

Example of a set of measurements for one incoming optics (“Optics 4”)

One streaking direction

The other direction

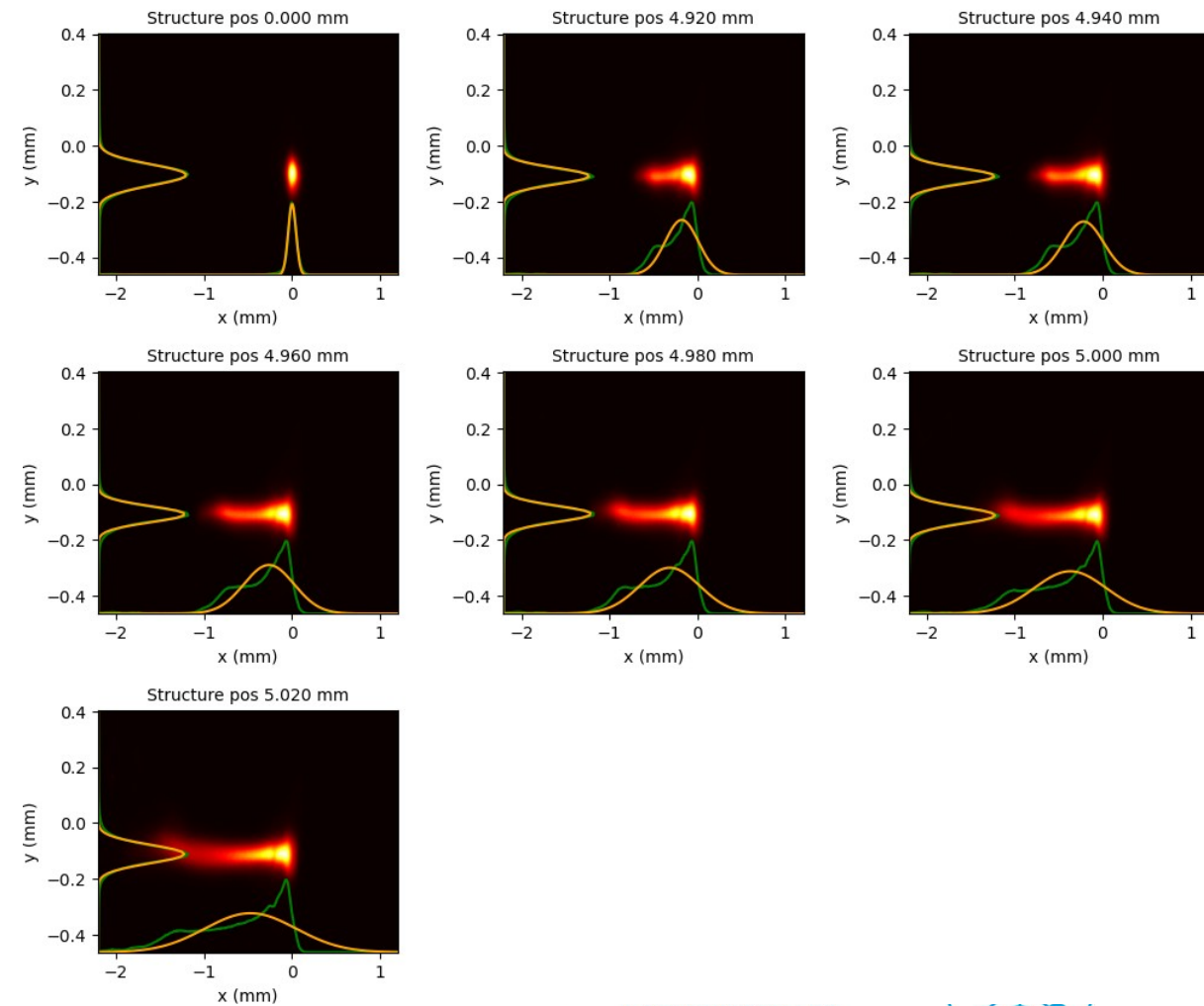
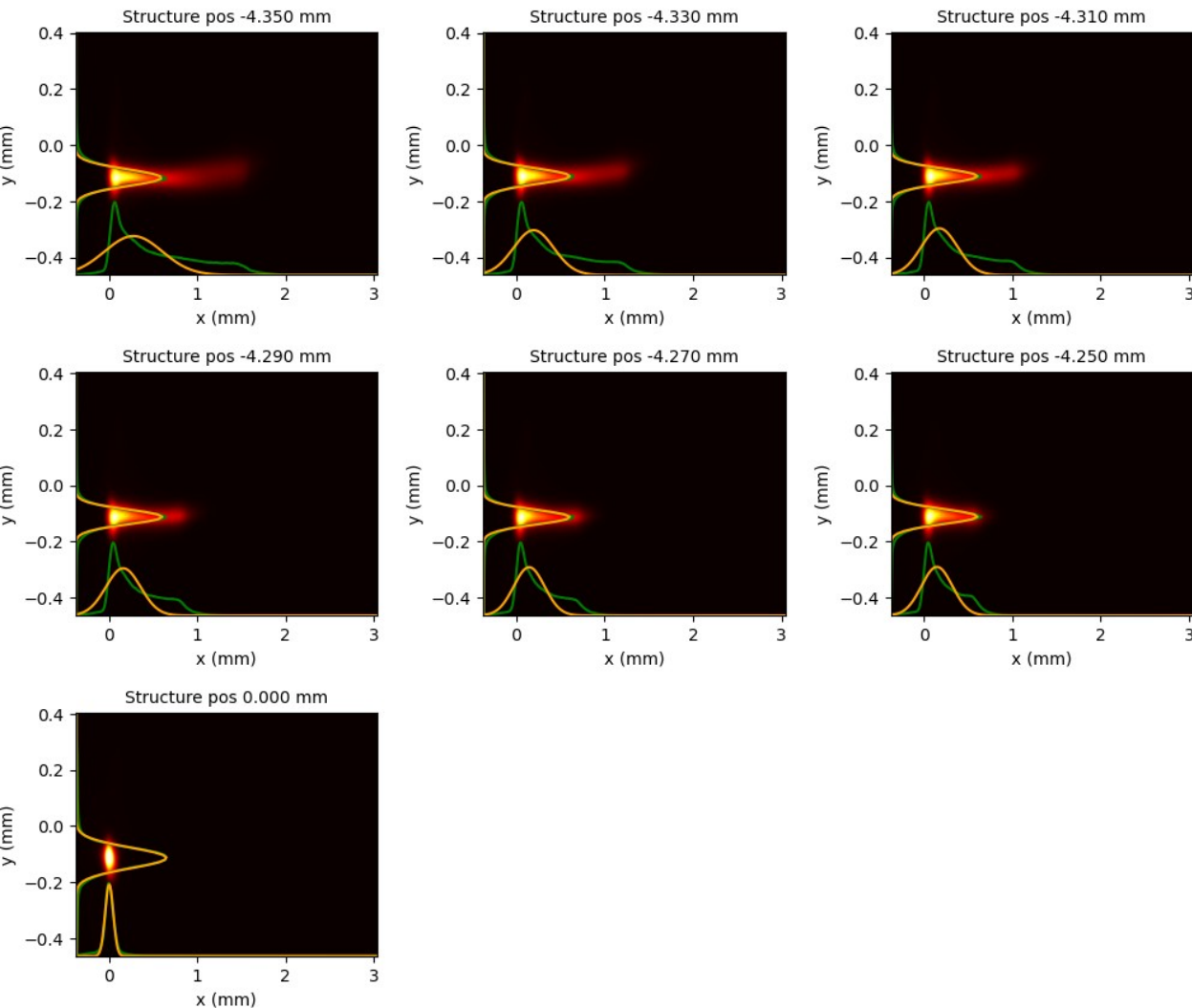
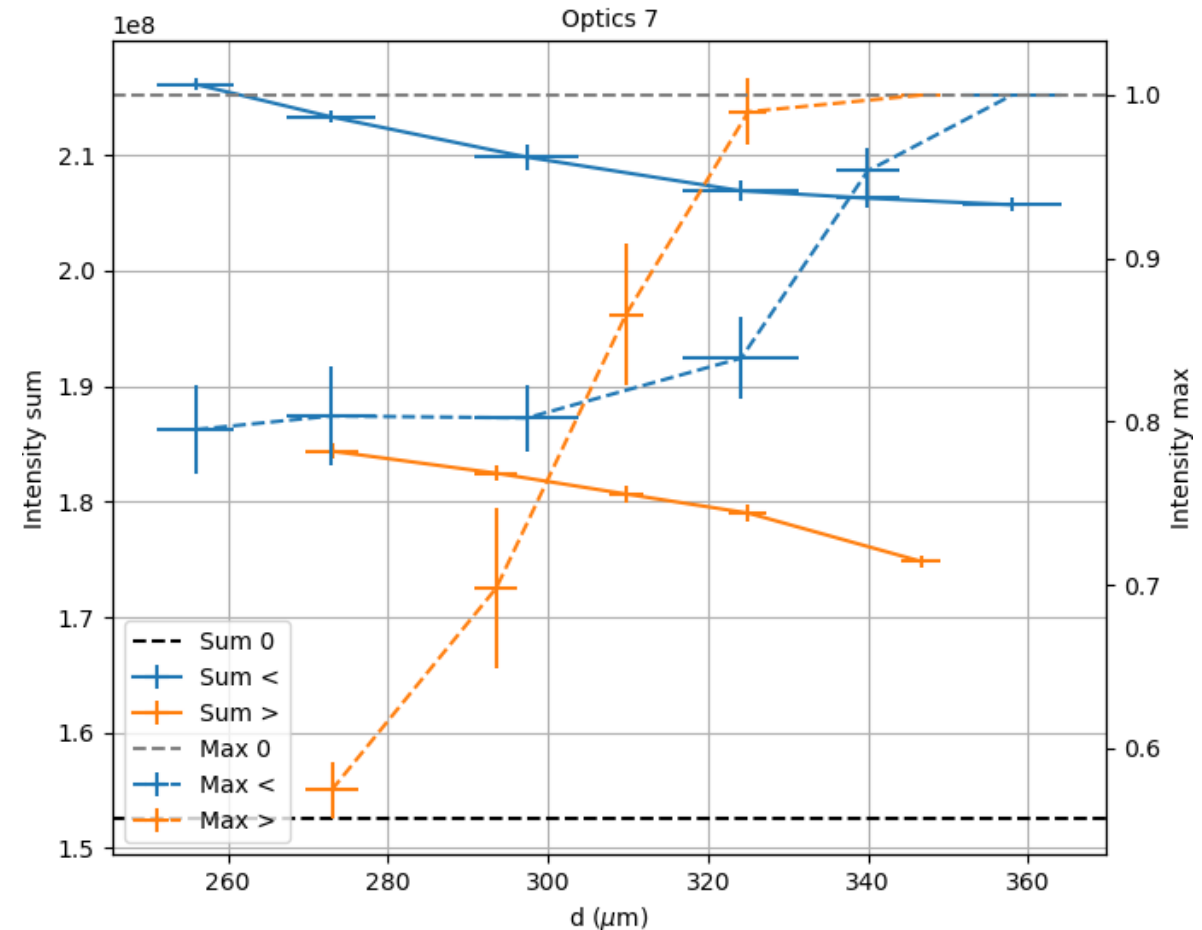
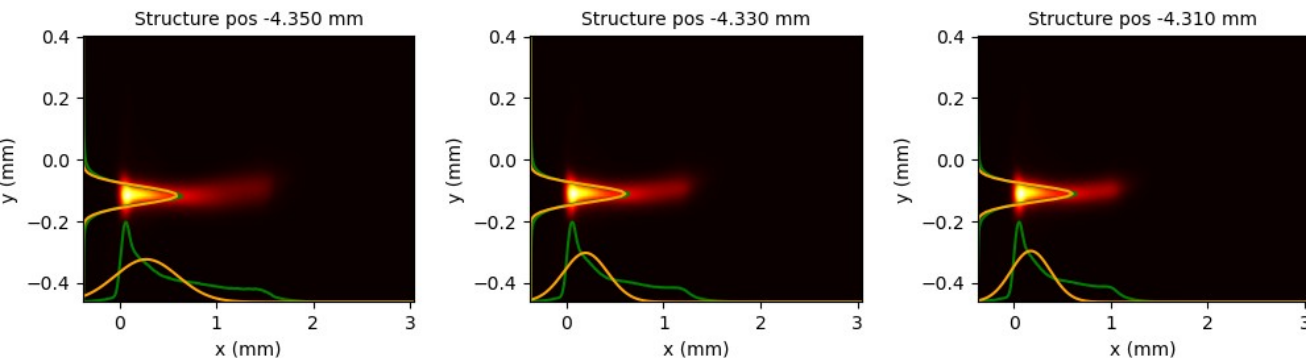

Image saturation at head of the beam

- Orange / blue: different streaking sides
- Solid lines: Intensity sum of all pixels
- Dashed lines: Intensity brightest pixel
- At PSI, camera gain is fixed but operators can use different camera filters: 100%, 10%, 1%
- Due to nonlinear streaking, there are parts with very high electron density at the image.
- Tradeoff between good resolution at the low density parts (10% filter), or less saturation at the high density parts (1% filter).
- We chose the 10% filter, but suffer from saturation at the head of the beam as a consequence.
- Does this effect also occur at European XFEL? Need to talk to Artem, Sergey.



Consistent: distances obtained from TDS calibration

- TDS calibration: distance between beam and closest corrugated plate is varied (in calculations), until kick obtained from TDS profile agrees with measured center of mass deflection at the screen
- Here are shown the calibrated distances from different structure positions.
- We think that we know the distance between subsequent positions well, due to the precise motors of the corrugated structure
- Small inconsistencies hopefully disappear by taking saturation into account (todo).

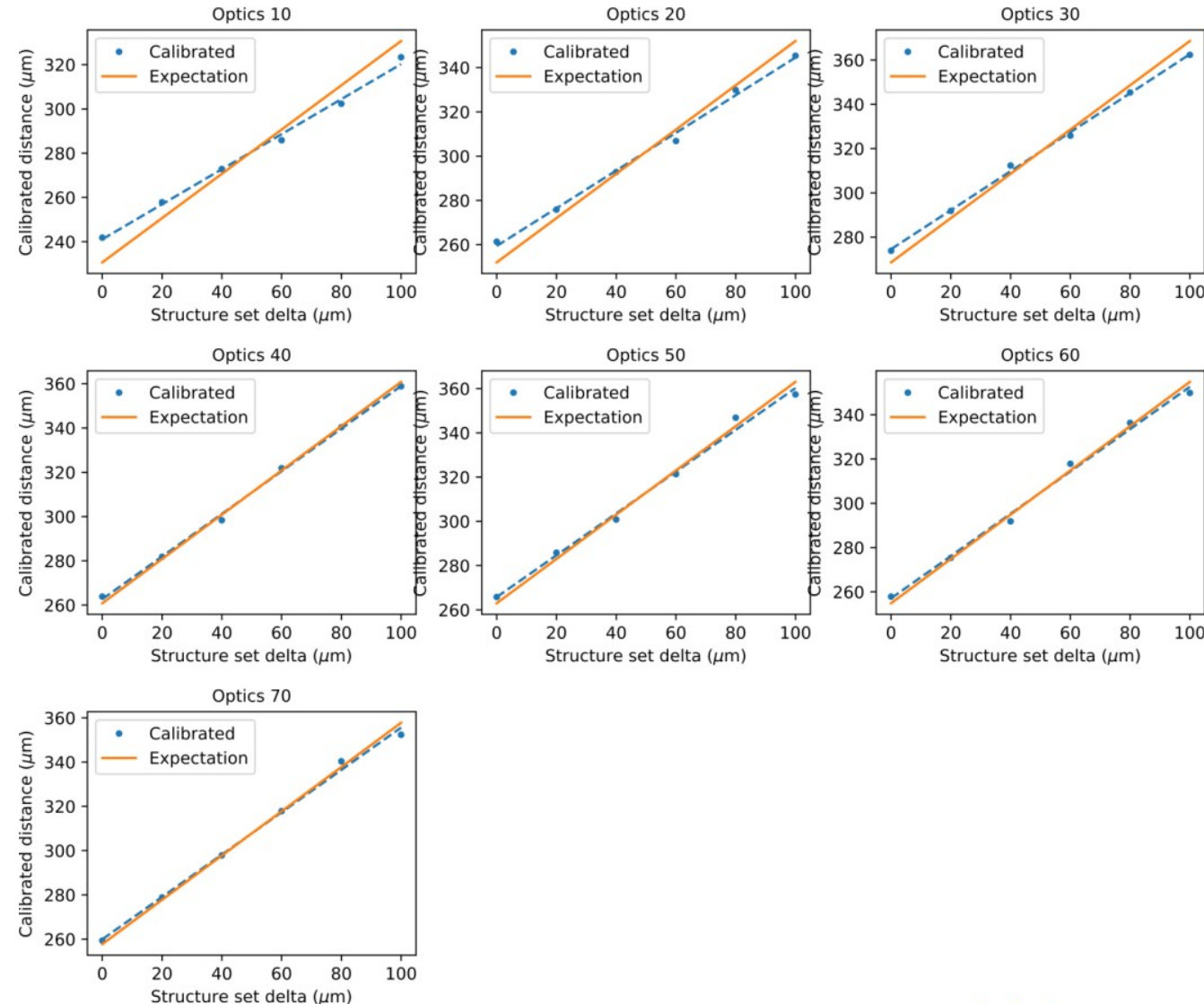

Direct measurements of quadrupole wakefield

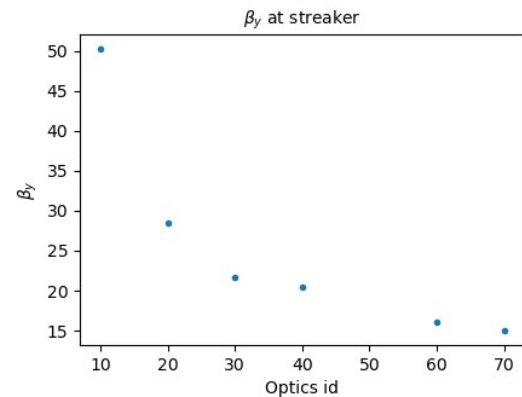
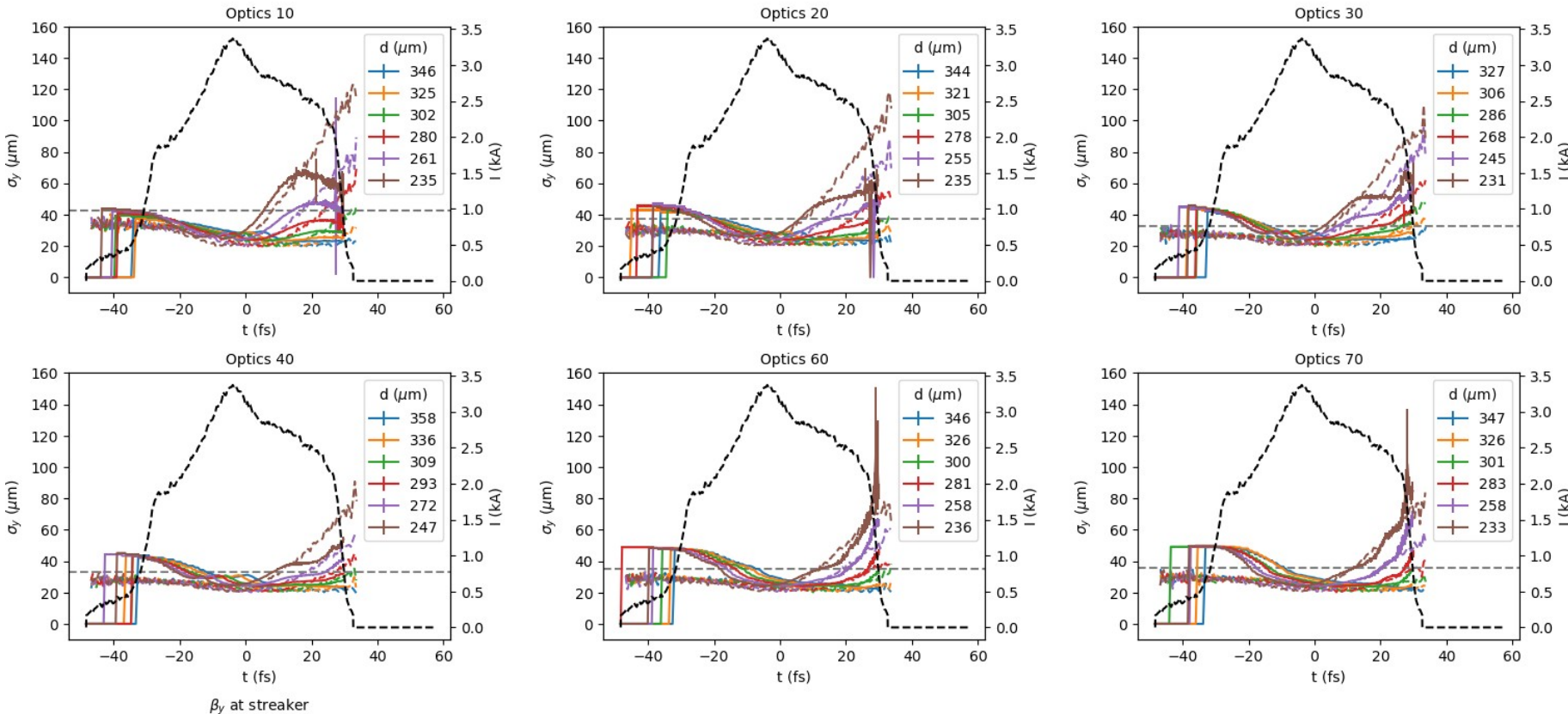

Todo: see whether better agreement can be reached also for higher β functions by varying initial optics

- Possible collaboration with Weilun and Igor: simulations in ECHO2D might reveal importance of modes higher than quadrupole.
- Other effects can be beam tilt already inside the structure

- Measurements at non-dispersive screen.
- Calibrate x axis (streaked direction) using TDS calibration
- Perform slice analysis to obtain vertical beam sizes.
- Compare to expected beam size (see earlier formula, but actually is done numerically.)
- Assume emittance of 200 nm, and measured optics at TDS location (slice for X, proj for Y).
- Disagreement for $t < -10$ fs can be explained by image saturation
- Excellent agreement for smaller β functions at the streaker.

Consistent: reconstructed current profiles

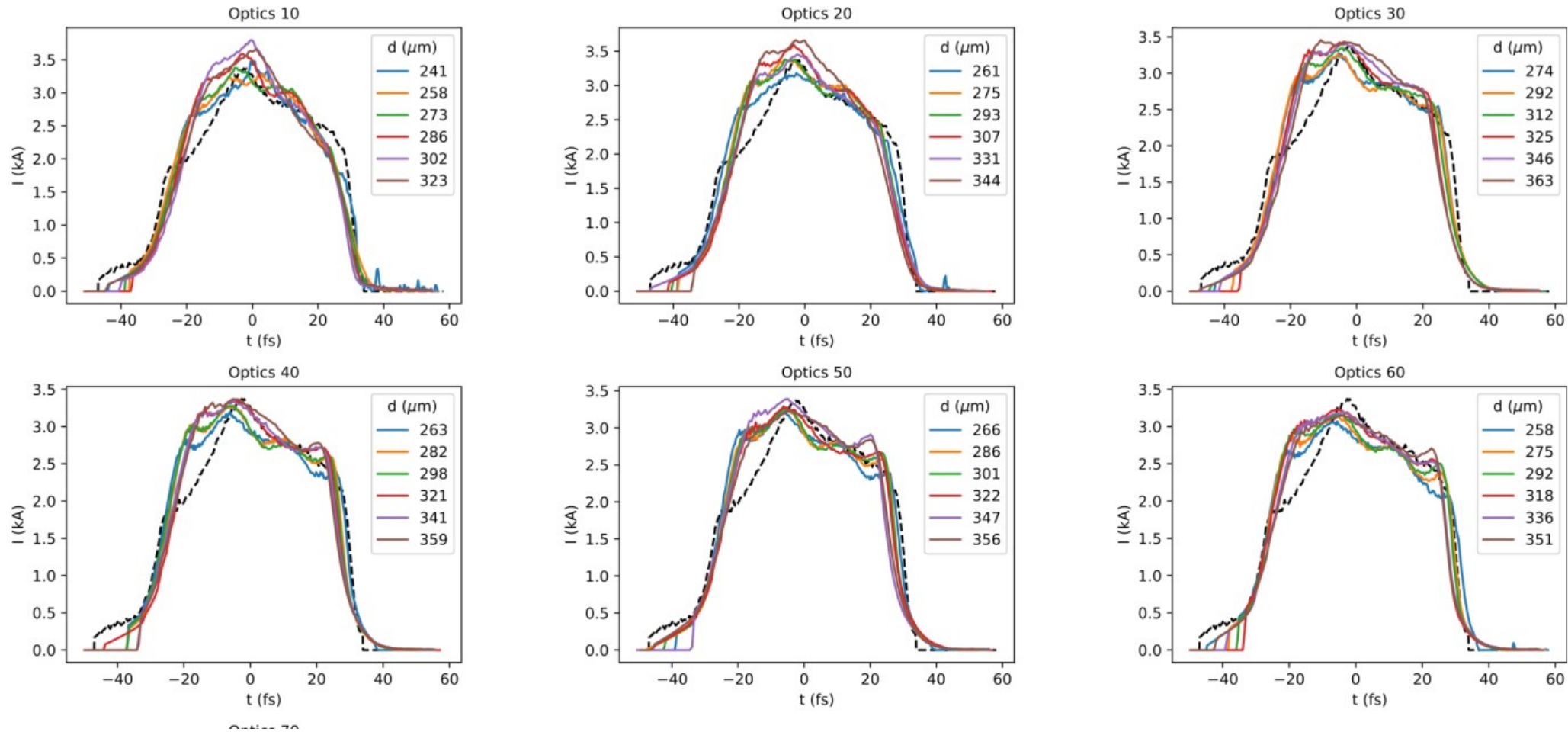

- That rms durations are the same is a direct consequence of the TDS calibration.
- But also the shapes of the current profile agree well.

Direct measurements of longitudinal dipole wakefields

Wake potentials calculated from TDS profile & distances calibrated from transverse center of mass kick

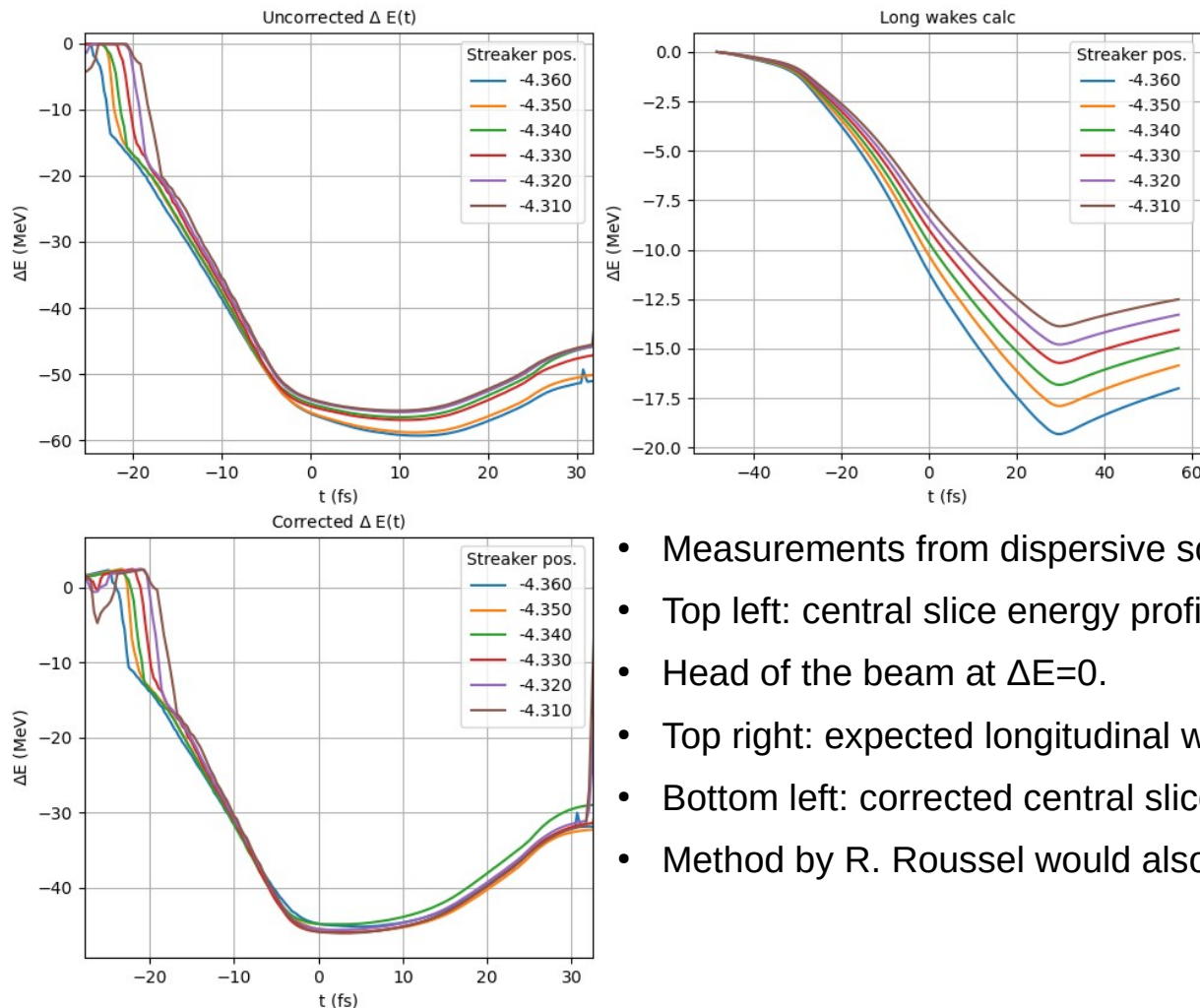

- Measurements from dispersive screen
- Top left: central slice energy profile before taking expected longitudinal wakes into account.
- Head of the beam at $\Delta E=0$.
- Top right: expected longitudinal wake potential.
- Bottom left: corrected central slice energy profile, with good agreement.
- Method by R. Roussel would also consider this information to reconstruct temporal profile of the beam.

Contents

- Other studies
 - Panofsky-Wenzel correction to model by Bane, Stupakov, Zagorodnov
 - Comparison of my own tracking / reconstruction code to OCELOT (Igor & Sergey)

Panofsky-Wenzel correction to Bane, Stupakov, Zagorodnov equations

- Paper by Bane et al. does not have an x dependency on the longitudinal wakes.
- According to Panofsky-Wenzel theorem, there should be one.
- This is correctly taken into account by Igor et al.'s paper. The equations from there are implemented in OCELOT.
- Through application of the theorem (as suggested by Marc and Alberto), I could obtain excellent agreement between the two models, at least for the SwissFEL working point, see next slide.

$$w_{l,Cd}(s, x) = - \int dx \frac{\partial w_d(s)}{\partial s} = -(x - x_0) \frac{\partial w_d(s)}{\partial s}$$

$$w_{l,Cq}(s, x, y) = - \left(\int dx \frac{\partial w_q(s)(x - x_0)}{\partial s} - \int dy \frac{\partial w_q(s)(y - y_0)}{\partial s} \right)$$

$$= - \frac{(x - x_0)^2 - (y - y_0)^2}{2} \frac{\partial w_q(s)}{\partial s}$$

Nuclear Instruments and Methods in Physics Research A 837 (2016) 69–79

$$\Delta\sigma_{\delta,Cd}^2(s) = \left(\frac{eW_{l,Cd}(s)}{E} \right)^2 \sigma_x^2, \quad \text{and}$$

$$\Delta\sigma_{\delta,Cq}^2(s) = \left(\frac{eW_{l,Cq}(s)}{E} \right)^2 \frac{3\sigma_x^4 + 3\sigma_y^4 - 2\sigma_x^2\sigma_y^2}{4}.$$

Slice energy spread increase due to dipole and quadrupole transverse wakes.



ELSEVIER

Contents lists available at [ScienceDirect](https://www.sciencedirect.com)

Nuclear Instruments and Methods in
Physics Research A

journal homepage: www.elsevier.com/locate/nima

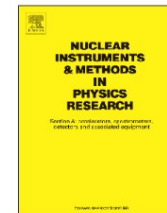

Corrugated structure insertion for extending the SASE bandwidth up to 3% at the European XFEL

I. Zagorodnov*, G. Feng, T. Limberg

Deutsches Elektronen-Synchrotron, Notkestrasse 85, 22603 Hamburg, Germany



Comparison of my own tracking code to OCELOT

Compare tracking methods. Aramis post-undulator passive streaker. Gap=10 mm. $d=250 \mu\text{m}$. $\epsilon=500 \text{ nm}$. $\beta_y=8.3 \text{ m}$. $\alpha_y=1.1$ 160 pC

- This calculation is for using small step sizes in OCELOT tracking
- My code (PWFM) always uses only 1 step (drift – kick – drift)
- I implemented a trick for the quadrupole wakefield, where I calculate and apply a 2D thick lens quadrupole matrix. This is the difference between “PWFM_thick” and “PWFM”.
- Takeaway: my own specialized, faster code is sufficient to obtain all important effects. It is not necessary to use OCELOT, which is much slower.

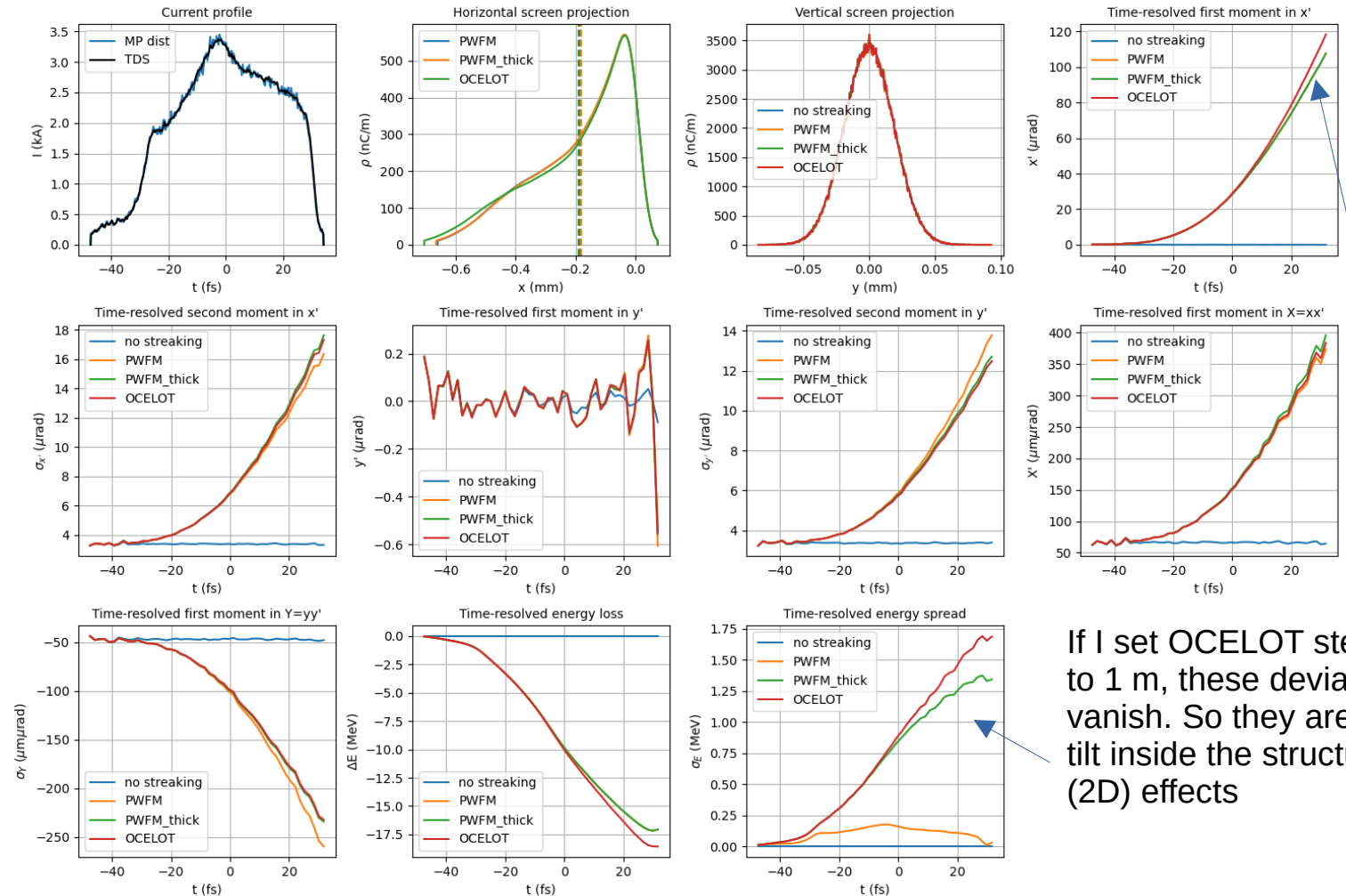

If I set OCELOT step size to 1 m, these deviations vanish. So they are “beam tilt inside the structure” (2D) effects

Status of diagnostics at European XFEL

- Current profile and LPS measurements work reasonably well. Results can be obtained within a few minutes.
- Measurements have been used to support beam setup for HXRSS, and 24/30 keV photon energy.
- Used extensively for development shifts in preparation for ASPECT.
- So far, only calibration with CRISP has been used.
- Problems with setting bumps, due to wrong magnet calibrations, non-constant incoming orbit, non-repeatable bump setting procedure.
- So far, no online analysis of the LPS. tool currently is for experts only.
- By next blue week we (Sergey, Weilun, myself) want to deliver a more polished tool, including online analysis of the images.
- Simultaneous DAQ of HIREX and screen images is possible at 3 Hz. Photon absorber not needed any more.
- The BPM before the structure will be moved during summer shutdown. Hopefully, self-consistent calibrations will afterwards be possible.



Corrugated structure design:
Torsten Wohlenberg

Future of diagnostics at European XFEL and summary

- My conclusion from the last couple of months is that the PSI design with movable plates is better than the fixed structure with orbit bumps.
- Two plates instead of one would facilitate a simple calibration method based on center of mass fit.
- Installing another screen before the spectrometer dipole could be a good idea, and could enable beam tilt measurements / transverse phase space tomography.
- Idea: vary phase advance in SASE2 by up to 180 degrees. Measure horizontal slice centroids (for beam tilt / slice displacement) and horizontal slice beam sizes (for slice optics / emittance).
- Or hopefully use improved reconstruction algorithms that provide all this information at once.
- Wakefield measurements presented earlier indicate that the wakefield model is excellent, therefore such measurements should be possible.
- New structures after SASE1 / SASE3 would be highly beneficial for development of new operation modes, in particular ASPECT.
- I am confident that Sergey and Weilun will take over also the reconstruction part of the measurements after I leave DESY in June.

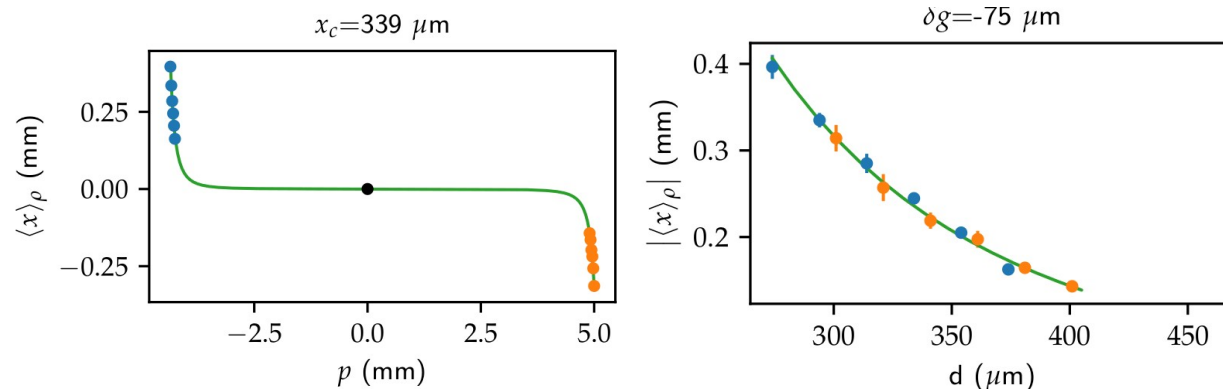

Center of mass streaking, measured at PSI

- Blue, orange: measurements from different streaking directions.
- Green: Model expectation
- Philipp Dijkstal, PhD thesis, <https://doi.org/10.3929/ethz-b-000576424>
- Only possible with double-sided structures, due to symmetry.

Thank you for your attention.

Many thanks to Eduard Prat, Alexander Malyzhenkov, Paolo Craievich, Sergey, Weilun, Igor, Alberto Lutman, Karl Bane