

BC parameter sensitivity + μ -bunch (in)stability

BC1+3rd & BC2

SC effects after last BC

dog & BC1+3rd & BC2

dog+3rd & BC1+3rd & BC2

BC0+3rd & BC1+3rd & BC2

sign of new (induced) modulation

75A-Gun, BC0+3rd & BC1+3rd & BC2



BC1+3rd & BC2

compression with BC1 and BC2

WRITEPRN("setup.dat") := BC_S1

$$BC_S1 = \begin{pmatrix} 0 & -1 \times 10^{-5} & 1 \\ 5 \times 10^8 & -0.103258 & 20 \\ 2 \times 10^9 & -0.0173908 & 100 \end{pmatrix}$$

$$\frac{rf^{(0)}}{MV} = \begin{pmatrix} 0 \\ 0 \\ 583.167 \\ 99.3 \\ 1.5 \times 10^3 \end{pmatrix} \quad \frac{rf^{(1)}}{\text{deg}} = \begin{pmatrix} 0 \\ 0 \\ 0.54 \\ 146.853 \\ 2.134 \times 10^{-14} \end{pmatrix}$$

$$\frac{BC_S1^{(0)}}{MV} = \begin{pmatrix} 0 \\ 500 \\ 2 \times 10^3 \end{pmatrix} \quad \frac{BC_S1^{(1)}}{0.001} = \begin{pmatrix} -0.01 \\ -103.3 \\ -17.39 \end{pmatrix} \quad BC_S1^{(2)} = \begin{pmatrix} 1 \\ 20 \\ 100 \end{pmatrix}$$

$$QT = \begin{pmatrix} 0 & 0 \\ 0.33 & 2.943 \end{pmatrix}$$

$$\frac{Ene3}{MV} = 1.75 \times 10^4$$

$$\frac{r56_3}{0.001} = 0.84$$

$$C3 = 0.9784$$

$$E_{rms} = 1 \times 10^4$$

$$Imax1 = 50$$

$$MV1 = 0$$

$$\text{deg1} = 0$$

$$Imax2 = 50$$

$$\Delta e2 = 0$$

$$MV2 = 0$$

$$\text{deg2} = 0$$

$$Imax3 = 1 \times 10^3$$

$$\Delta e3 = -0.022$$

$$MV3 = \begin{pmatrix} 0.198 & -1 \\ -0.161 & 1 \end{pmatrix}$$

$$\text{deg3} = \begin{pmatrix} 0.015 & 1 \\ -0.018 & -1 \end{pmatrix}$$

$$Imax4 = 5000$$

$$\Delta e4 = -5.471 \times 10^{-3}$$

$$MV4 = \begin{pmatrix} 0.059 & 1 \\ -0.08 & -1 \end{pmatrix}$$

$$\text{deg4} = \begin{pmatrix} 0.055 & -1 \\ -0.044 & 1 \end{pmatrix}$$

$$\frac{\Delta e4 \cdot BC_S1_{2,0}}{MV} = -10.942$$

$$MV5 = \begin{pmatrix} 18.526 & -1 \\ -15.148 & 1 \end{pmatrix}$$

$$\text{deg5} = \begin{pmatrix} 2.613 & 1 \\ -4.406 & -1 \end{pmatrix}$$

$$\min(\text{stack}(\text{am}, \text{ph})) = 2.912 \times 10^{-4}$$

$$\min(\text{am}) = 3.079 \times 10^{-4}$$

$$\min(\text{ph}) = 2.912 \times 10^{-4}$$

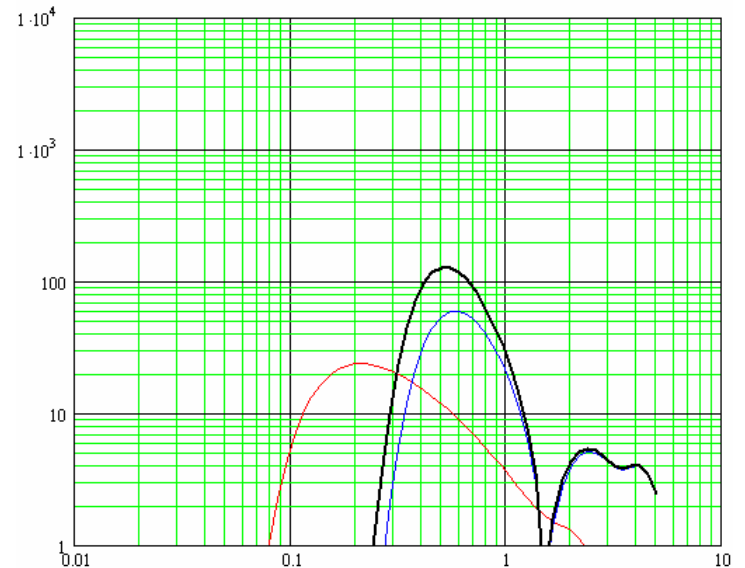
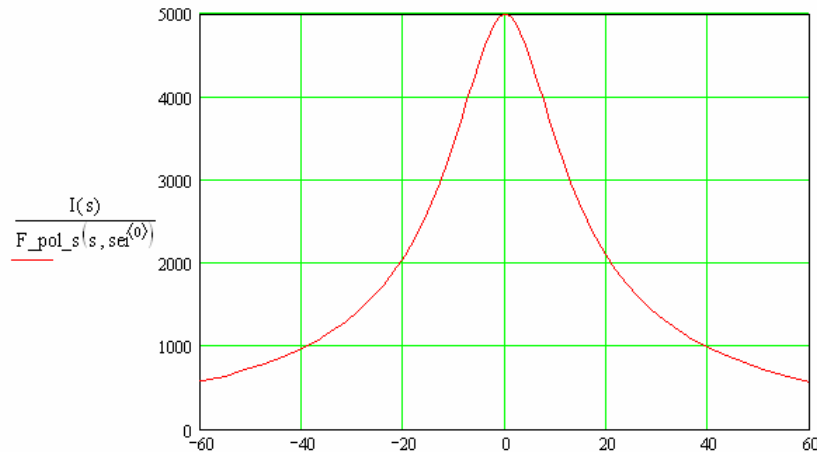

example: SC effects after last BC

European XFEL:

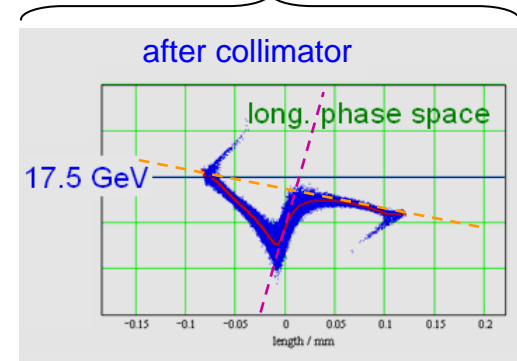
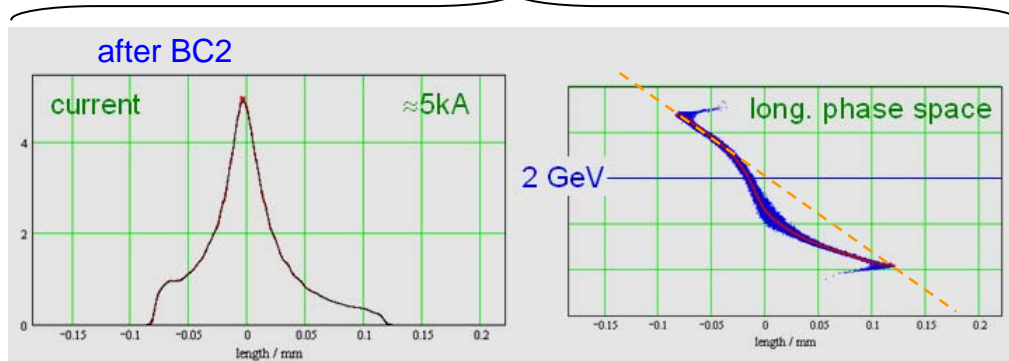
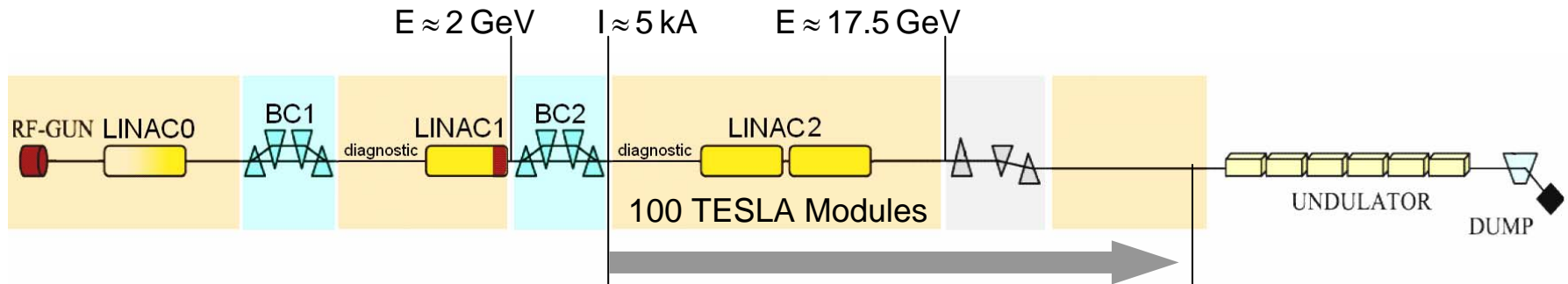

negative chirp compensated by LINAC wakes
positive chirp induced by space charge !



BC1+3rd & BC2

compression with BC1 and BC2

WRITEPRN("setup.dat") := BC_S1

$$BC_S1 = \begin{pmatrix} 0 & -1 \times 10^{-5} & 1 \\ 5 \times 10^8 & -0.103258 & 20 \\ 2 \times 10^9 & -0.0173908 & 100 \end{pmatrix}$$

$$\frac{rf^{(0)}}{MV} = \begin{pmatrix} 0 \\ 0 \\ 808.877 \\ 256.814 \\ 1.5 \times 10^3 \end{pmatrix} \quad \frac{rf^{(1)}}{\text{deg}} = \begin{pmatrix} 0 \\ 0 \\ -43.869 \\ 108.889 \\ 2.134 \times 10^{-14} \end{pmatrix}$$

$$\frac{BC_S1^{(0)}}{MV} = \begin{pmatrix} 0 \\ 500 \\ 2 \times 10^3 \end{pmatrix} \quad \frac{BC_S1^{(1)}}{0.001} = \begin{pmatrix} -0.01 \\ -103.3 \\ -17.39 \end{pmatrix} \quad BC_S1^{(2)} = \begin{pmatrix} 1 \\ 20 \\ 100 \end{pmatrix}$$

$$QT = \begin{pmatrix} 0 & 0 \\ 0.33 & 12 \end{pmatrix}$$

$$\frac{Ene3}{MV} = 1.75 \times 10^4$$

$$\frac{r56_3}{0.001} = 0.84$$

$$C3 = 0.9784$$

$$E_{rms} = 1 \times 10^4$$

$$Imax1 = 50$$

$$MV1 = 0$$

$$deg1 = 0$$

$$Imax2 = 50$$

$$\Delta e2 = 0$$

$$MV2 = 0$$

$$deg2 = 0$$

$$Imax3 = 1 \times 10^3$$

$$\Delta e3 = -0.021$$

$$MV3 = \begin{pmatrix} 0.138 & -1 \\ -0.111 & 1 \end{pmatrix}$$

$$deg3 = \begin{pmatrix} 0.222 & 1 \\ -0.229 & -1 \end{pmatrix}$$

$$Imax4 = 5000$$

$$\Delta e4 = -5.366 \times 10^{-3}$$

$$MV4 = \begin{pmatrix} 0.044 & 1 \\ -0.064 & -1 \end{pmatrix}$$

$$deg4 = \begin{pmatrix} 0.635 & -1 \\ -0.629 & 1 \end{pmatrix}$$

$$\frac{\Delta e4 \cdot BC_S1_{2,0}}{MV} = -10.732$$

$$MV5 = \begin{pmatrix} 18.526 & -1 \\ -15.149 & 1 \end{pmatrix}$$

$$deg5 = \begin{pmatrix} 2.613 & 1 \\ -4.406 & -1 \end{pmatrix}$$

$$\min(\text{stack}(\text{am}, \text{ph})) = 1.536 \times 10^{-4}$$

$$\min(\text{am}) = 1.536 \times 10^{-4}$$

$$\min(\text{ph}) = 3.933 \times 10^{-3}$$

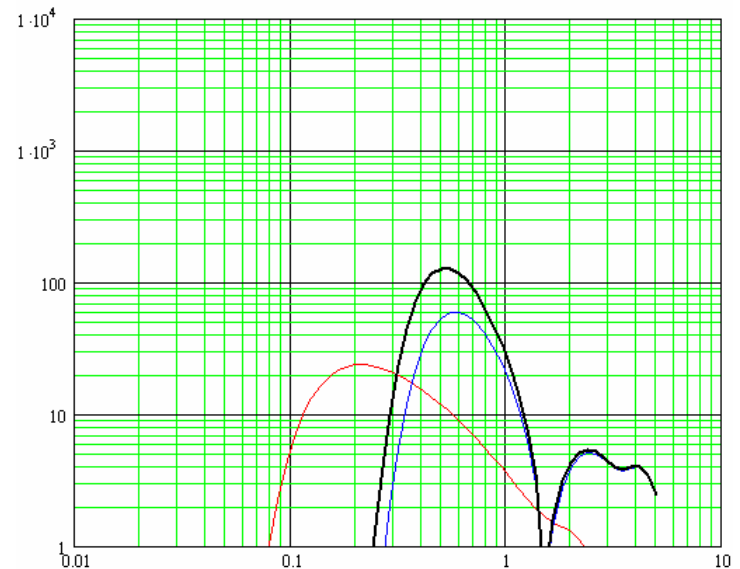
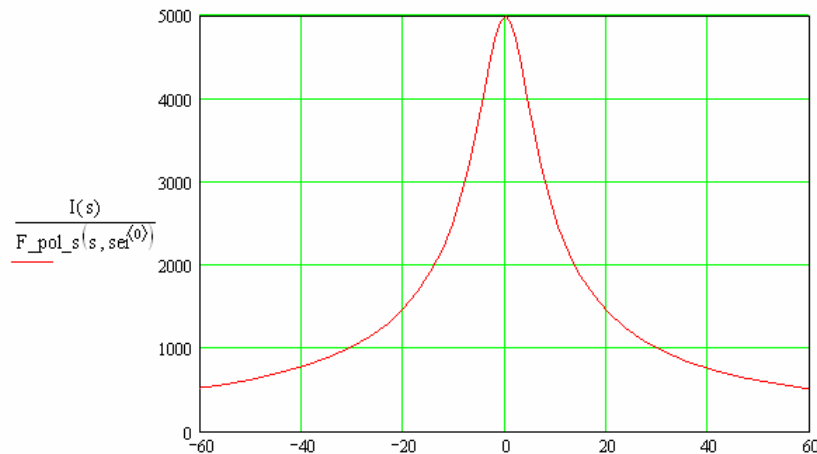

75A-Gun, BC1+3rd & BC2

compression with BC1 and BC2

WRITEPRN("setup.dat") := BC_S1

$$BC_S1 = \begin{pmatrix} 0 & -1 \times 10^{-5} & 1 \\ 5 \times 10^8 & -0.07 & 8 \\ 2 \times 10^9 & -0.020857 & 66.6666667 \end{pmatrix}$$

$$\frac{rf^{(0)}}{MV} = \begin{pmatrix} 0 \\ 0 \\ 605.358 \\ 113.398 \\ 1.958 \times 10^3 \end{pmatrix} \quad \frac{rf^{(1)}}{\text{deg}} = \begin{pmatrix} 0 \\ 0 \\ 6.969 \\ 152.831 \\ 40 \end{pmatrix}$$

$$QT = \begin{pmatrix} 0 & 0 \\ 0.614 & 2.943 \end{pmatrix}$$

Imax1 = 75

MV1 = 0

deg1 = 0

Imax2 = 75 Δe2 = 0

MV2 = 0

deg2 = 0

Imax3 = 600.022 Δe3 = -0.02

$$MV3 = \begin{pmatrix} 0.769 & -1 \\ -0.621 & 1 \end{pmatrix}$$

$$\text{deg3} = \begin{pmatrix} 0.043 & 1 \\ -0.052 & -1 \end{pmatrix}$$

Imax4 = 5000 Δe4 = -8.496 × 10⁻³

$$\frac{\Delta e4 \cdot BC_S1_{2,0}}{MV} = -16.993$$

$$MV4 = \begin{pmatrix} 0.226 & 1 \\ -0.279 & -1 \end{pmatrix}$$

$$\text{deg4} = \begin{pmatrix} 0.137 & -1 \\ -0.112 & 1 \end{pmatrix}$$

$$MV5 = \begin{pmatrix} 16.05 & -1 \\ -13.202 & 1 \end{pmatrix}$$

$$\text{deg5} = \begin{pmatrix} 0.277 & 1 \\ -0.381 & -1 \end{pmatrix}$$

min(stack(am, ph)) = 8.274 × 10⁻⁴

min(am) = 1.148 × 10⁻³

min(ph) = 8.274 × 10⁻⁴

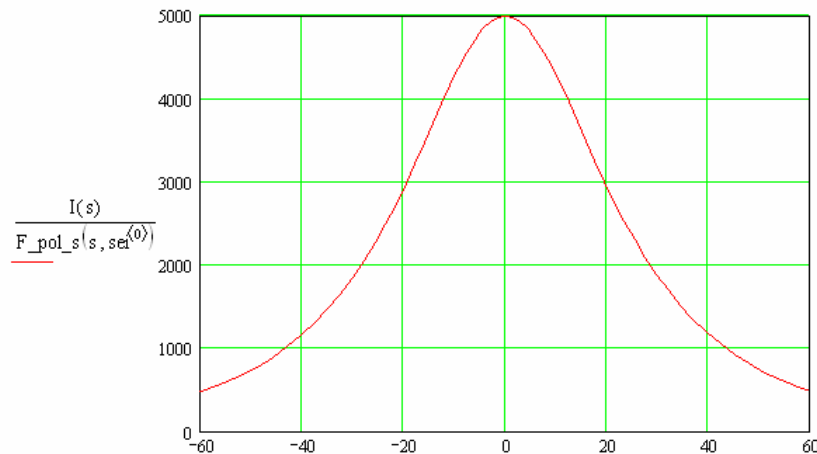

$$\frac{BC_S1^{(0)}}{MV} = \begin{pmatrix} 0 \\ 500 \\ 2 \times 10^3 \end{pmatrix} \quad \frac{BC_S1^{(1)}}{0.001} = \begin{pmatrix} -0.01 \\ -70 \\ -20.86 \end{pmatrix} \quad BC_S1^{(2)} = \begin{pmatrix} 1 \\ 8 \\ 66.67 \end{pmatrix}$$

$$\frac{Ene3}{MV} = 1.75 \times 10^4 \quad \frac{r56_3}{0.001} = 0.84 \quad C3 = 0.96735$$

$$E_{rms} = 1 \times 10^4$$

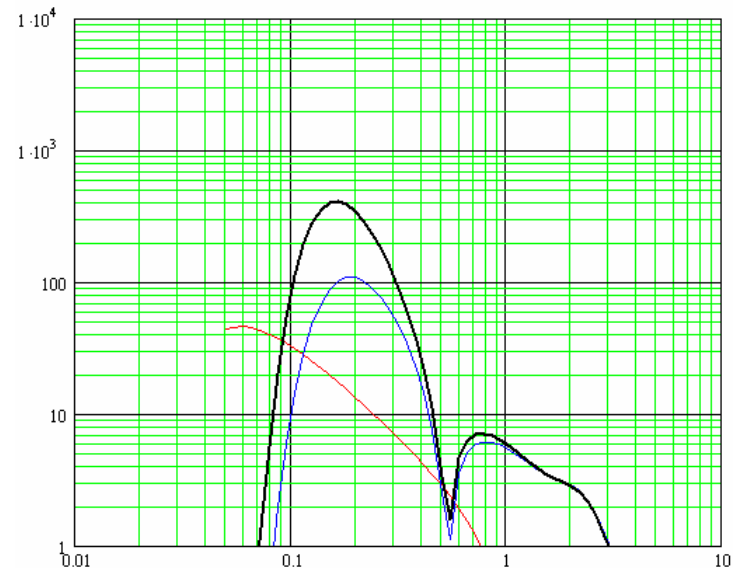

dog & BC1+3rd & BC2

ccompression with dog, BC1, BC2
(t566_dog=1.0m)

WRITEPRN("setup.dat") := BC_S1

$$BC_S1 = \begin{pmatrix} 1.3 \times 10^8 & 0.02 & 1.1 \\ 5 \times 10^8 & -0.1 & 13.6363636 \\ 2 \times 10^9 & -0.021768 & 100 \end{pmatrix}$$

$$\frac{rf^{(0)}}{MV} = \begin{pmatrix} 131.787 \\ 0 \\ 455.246 \\ 98.192 \\ 1.596 \times 10^3 \end{pmatrix} \quad \frac{rf^{(1)}}{deg} = \begin{pmatrix} -9.447 \\ 0 \\ 4.892 \\ 148.35 \\ 20 \end{pmatrix}$$

$$\frac{BC_S1^{(0)}}{MV} = \begin{pmatrix} 130 \\ 500 \\ 2 \times 10^3 \end{pmatrix} \quad \frac{BC_S1^{(1)}}{0.001} = \begin{pmatrix} 20 \\ -100 \\ -21.77 \end{pmatrix} \quad BC_S1^{(2)} = \begin{pmatrix} 1.1 \\ 13.64 \\ 100 \end{pmatrix}$$

$$QT = \begin{pmatrix} 0 & 0 \\ 0.597 & 2.86 \end{pmatrix}$$

$$\frac{Ene4}{MV} = 1.75 \times 10^4$$

$$\frac{r56_4}{0.001} = 0.84$$

$$C4 = 0.97563$$

$$E_{rms} = 1 \times 10^4$$

$$Imax1 = 50$$

$$MV1 = \begin{pmatrix} 0.118 & -1 \\ -0.087 & 1 \end{pmatrix} \quad deg1 = \begin{pmatrix} 0.104 & 1 \\ -0.133 & -1 \end{pmatrix}$$

$$Imax2 = 55.118 \quad \Delta e2 = 0.011$$

$$MV2 = 0 \quad deg2 = 0$$

$$Imax3 = 752.086 \quad \Delta e3 = -0.021$$

$$MV3 = \begin{pmatrix} 0.318 & -1 \\ -0.257 & 1 \end{pmatrix} \quad deg3 = \begin{pmatrix} 0.024 & 1 \\ -0.029 & -1 \end{pmatrix}$$

$$Imax4 = 5000 \quad \Delta e4 = -6.411 \times 10^{-3}$$

$$MV4 = \begin{pmatrix} 0.087 & 1 \\ -0.109 & -1 \end{pmatrix} \quad deg4 = \begin{pmatrix} 0.07 & -1 \\ -0.057 & 1 \end{pmatrix}$$

$$\frac{\Delta e4 \cdot BC_S1_{2,0}}{MV} = -12.821$$

$$MV5 = \begin{pmatrix} 15.18 & -1 \\ -12.444 & 1 \end{pmatrix} \quad deg5 = \begin{pmatrix} 0.666 & 1 \\ -0.857 & -1 \end{pmatrix}$$

$$\min(\text{stack}(\text{am}, \text{ph})) = 4.666 \times 10^{-4} \quad \min(\text{am}) = 6.317 \times 10^{-4} \quad \min(\text{ph}) = 4.666 \times 10^{-4}$$

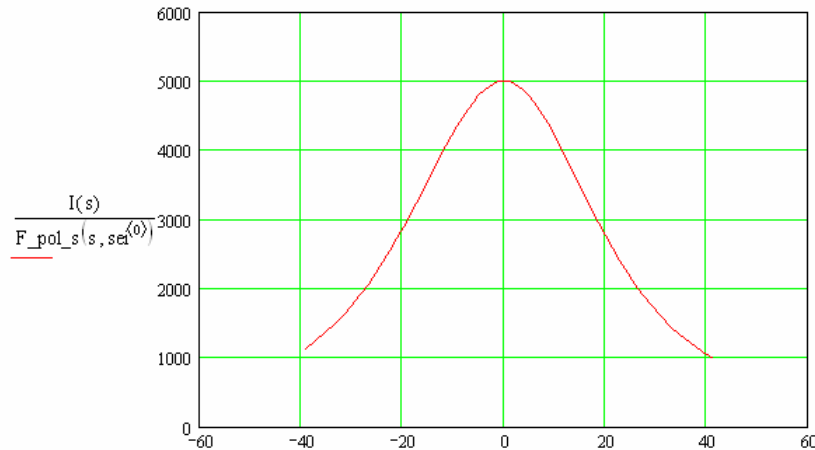
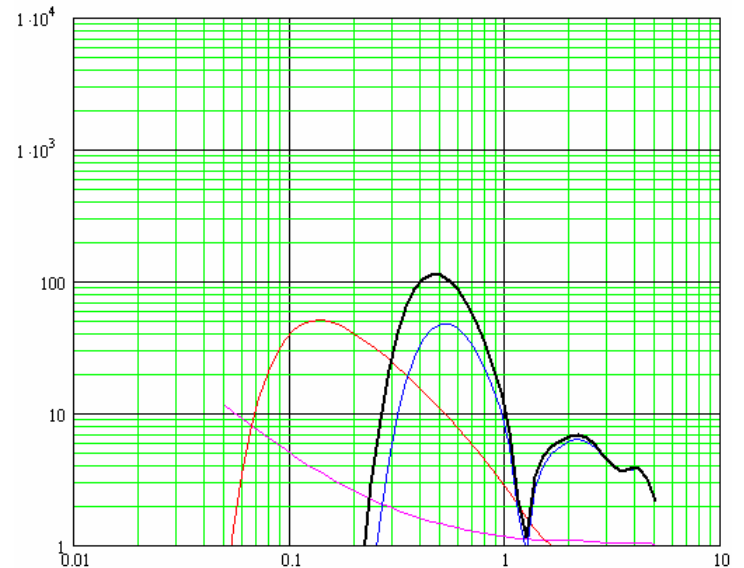

dog & BC1+3rd & BC2

ccompression with dog, BC1, BC2 (t566_dog=1.0m)

WRITEPRN("setup.dat") := BC_S1

$$BC_S1 = \begin{pmatrix} 1.3 \times 10^8 & 0.04 & 1.2 \\ 5 \times 10^8 & -0.1 & 10 \\ 2 \times 10^9 & -0.0293752 & 100 \end{pmatrix}$$

$$\frac{rf^{(0)}}{MV} = \begin{pmatrix} 131.503 \\ 0 \\ 460.377 \\ 101.175 \\ 1.596 \times 10^3 \end{pmatrix} \quad \frac{rf^{(1)}}{\text{deg}} = \begin{pmatrix} -8.672 \\ 0 \\ 5.167 \\ 151.02 \\ 20 \end{pmatrix}$$

$$\frac{BC_S1^{(0)}}{MV} = \begin{pmatrix} 130 \\ 500 \\ 2 \times 10^3 \end{pmatrix} \quad \frac{BC_S1^{(1)}}{0.001} = \begin{pmatrix} 40 \\ -100 \\ -29.38 \end{pmatrix} \quad BC_S1^{(2)} = \begin{pmatrix} 1.2 \\ 10 \\ 100 \end{pmatrix}$$

$$QT = \begin{pmatrix} 0 & 0 \\ 0.676 & 2.73 \end{pmatrix}$$

$$\frac{Ene4}{MV} = 1.75 \times 10^4$$

$$\frac{r56_4}{0.001} = 0.84$$

$$C4 = 0.9766$$

$$E_{rms} = 1 \times 10^4$$

$$Imax1 = 50$$

$$MV1 = \begin{pmatrix} 0.323 & -1 \\ -0.158 & 1 \end{pmatrix} \quad \text{deg1} = \begin{pmatrix} 0.081 & 1 \\ -0.101 & -1 \end{pmatrix}$$

$$Imax2 = 60.005 \quad \Delta e2 = 9.966 \times 10^{-3}$$

$$MV2 = 0 \quad \text{deg2} = 0$$

$$Imax3 = 600.24 \quad \Delta e3 = -0.018$$

$$Imax4 = 5000 \quad \Delta e4 = -6.132 \times 10^{-3}$$

$$\frac{\Delta e4 \cdot BC_S1_{2,0}}{MV} = -12.265$$

$$MV3 = \begin{pmatrix} 0.42 & -1 \\ -0.34 & 1 \end{pmatrix} \quad \text{deg3} = \begin{pmatrix} 0.027 & 1 \\ -0.033 & -1 \end{pmatrix}$$

$$MV4 = \begin{pmatrix} 0.109 & 1 \\ -0.136 & -1 \end{pmatrix} \quad \text{deg4} = \begin{pmatrix} 0.072 & -1 \\ -0.059 & 1 \end{pmatrix}$$

$$MV5 = \begin{pmatrix} 12.064 & -1 \\ -9.886 & 1 \end{pmatrix} \quad \text{deg5} = \begin{pmatrix} 0.465 & 1 \\ -0.59 & -1 \end{pmatrix}$$

$$\min(\text{stack}(\text{am}, \text{ph})) = 5.292 \times 10^{-4} \quad \min(\text{am}) = 8.251 \times 10^{-4} \quad \min(\text{ph}) = 5.292 \times 10^{-4}$$

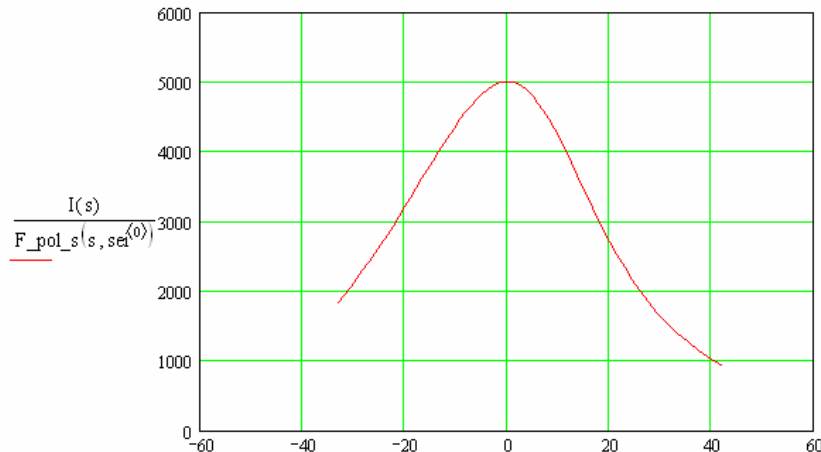
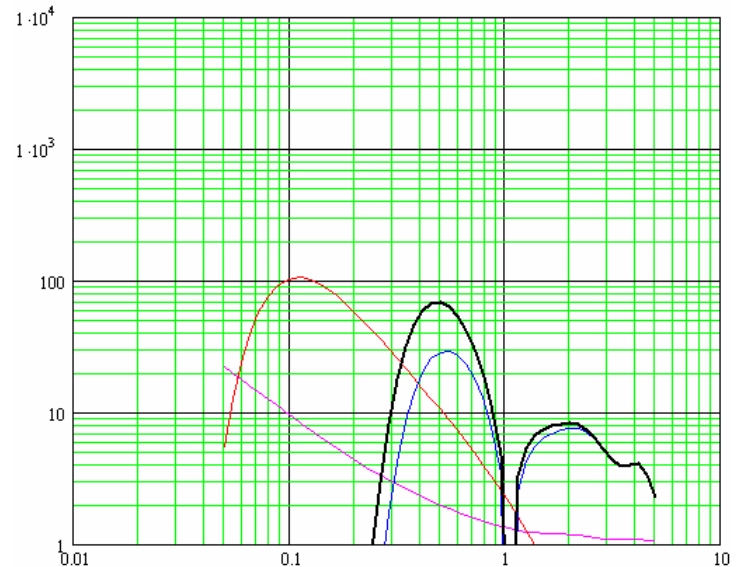

dog & BC1+3rd & BC2

compression with dog, BC1, BC2
(t566_dog=1.0m)

WRITEPRN("setup.dat") := BC_S1

$$BC_S1 = \begin{pmatrix} 1.3 \times 10^8 & 0.04 & 1.2 \\ 4 \times 10^8 & -0.1 & 8.3333333 \\ 2 \times 10^9 & -0.0272687 & 100 \end{pmatrix}$$

$$\frac{rf^{(0)}}{MV} = \begin{pmatrix} 131.503 \\ 0 \\ 346.869 \\ 100.309 \\ 2.089 \times 10^3 \end{pmatrix} \quad \frac{rf^{(1)}}{deg} = \begin{pmatrix} -8.672 \\ 0 \\ -9.253 \\ 136.164 \\ 40 \end{pmatrix}$$

$$QT = \begin{pmatrix} 0 & 0 \\ 0.772 & 4.55 \end{pmatrix}$$

Imax1 = 50

$$MV1 = \begin{pmatrix} 1.08 & 1 \\ -0.277 & 1 \end{pmatrix} \quad deg1 = \begin{pmatrix} 0.095 & 1 \\ -0.118 & -1 \end{pmatrix}$$

Imax2 = 60.005 $\Delta e2 = 9.966 \times 10^{-3}$

MV2 = 0 deg2 = 0

Imax3 = 500.003 $\Delta e3 = -0.018$

$$MV3 = \begin{pmatrix} 0.661 & -1 \\ -0.513 & 1 \end{pmatrix} \quad deg3 = \begin{pmatrix} 0.052 & 1 \\ -0.063 & -1 \end{pmatrix}$$

Imax4 = 5000 $\Delta e4 = -8.198 \times 10^{-3}$

$$MV4 = \begin{pmatrix} 0.12 & 1 \\ -0.151 & -1 \end{pmatrix} \quad deg4 = \begin{pmatrix} 0.106 & -1 \\ -0.087 & 1 \end{pmatrix}$$

$$\frac{\Delta e4 \cdot BC_S1_{2,0}}{MV} = -16.397$$

$$MV5 = \begin{pmatrix} 13.929 & -1 \\ -11.473 & 1 \end{pmatrix} \quad deg5 = \begin{pmatrix} 0.186 & 1 \\ -0.29 & -1 \end{pmatrix}$$

$\min(\text{stack}(\text{am}, \text{ph})) = 9.988 \times 10^{-4}$ $\min(\text{am}) = 1.354 \times 10^{-3}$ $\min(\text{ph}) = 9.988 \times 10^{-4}$

$$\frac{BC_S1^{(0)}}{MV} = \begin{pmatrix} 130 \\ 400 \\ 2 \times 10^3 \end{pmatrix} \quad \frac{BC_S1^{(1)}}{0.001} = \begin{pmatrix} 40 \\ -100 \\ -27.27 \end{pmatrix} \quad BC_S1^{(2)} = \begin{pmatrix} 1.2 \\ 8.333 \\ 100 \end{pmatrix}$$

$$\frac{Ene4}{MV} = 1.75 \times 10^4 \quad \frac{t56_4}{0.001} = 0.84 \quad C4 = 0.96929$$

$$E_{rms} = 1 \times 10^4$$

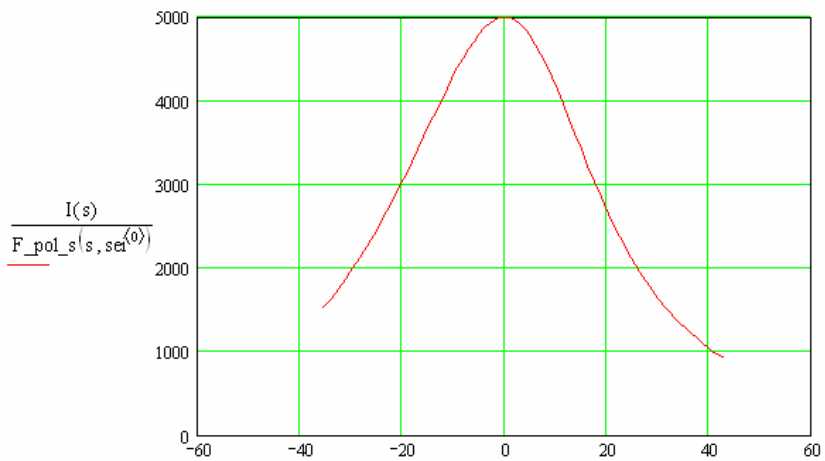
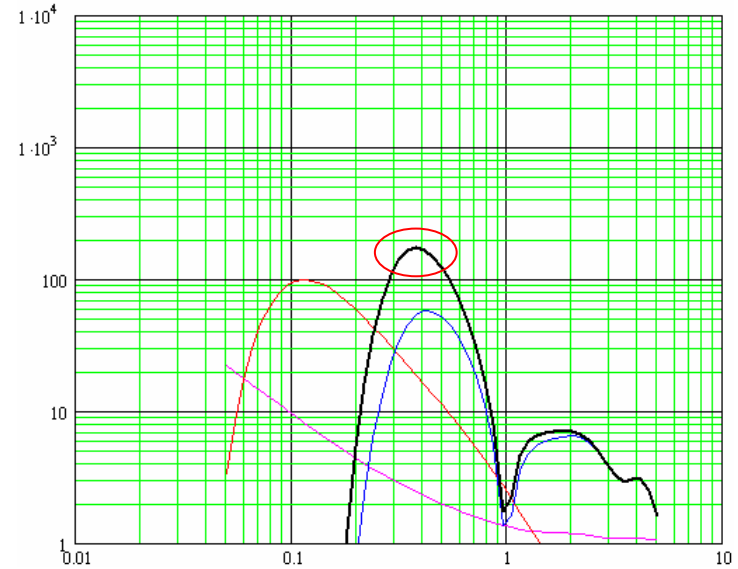

dog & BC1+3rd & BC2

compression with dog, BC1, BC2
(t566_dog=1.0m)

WRITEPRN("setup.dat") := BC_S1

$$BC_S1 = \begin{pmatrix} 1.3 \times 10^8 & 0.05 & 1.25 \\ 5 \times 10^8 & -0.1 & 8 \\ 2 \times 10^9 & -0.0360617 & 100 \end{pmatrix}$$

$$\frac{rf^{(0)}}{MV} = \begin{pmatrix} 131.386 \\ 0 \\ 462.386 \\ 103.417 \\ 1.596 \times 10^3 \end{pmatrix} \quad \frac{rf^{(1)}}{deg} = \begin{pmatrix} -8.33 \\ 0 \\ 4.504 \\ 151.586 \\ 20 \end{pmatrix}$$

$$\frac{BC_S1^{(0)}}{MV} = \begin{pmatrix} 130 \\ 500 \\ 2 \times 10^3 \end{pmatrix}$$

$$\frac{BC_S1^{(1)}}{0.001} = \begin{pmatrix} 50 \\ -100 \\ -36.06 \end{pmatrix}$$

$$BC_S1^{(2)} = \begin{pmatrix} 1.25 \\ 8 \\ 100 \end{pmatrix}$$

$$QT = \begin{pmatrix} 0 & 0 \\ 0.715 & 2.73 \end{pmatrix}$$

$$\frac{Ene4}{MV} = 1.75 \times 10^4$$

$$\frac{r56_4}{0.001} = 0.84$$

$$C4 = 0.9766$$

$$E_{rms} = 1 \times 10^4$$

$$Imax1 = 50$$

$$MV1 = \begin{pmatrix} 0.713 & 1 \\ -0.291 & 1 \end{pmatrix} \quad deg1 = \begin{pmatrix} 0.075 & 1 \\ -0.092 & -1 \end{pmatrix}$$

$$Imax2 = 62.507 \quad \Delta e2 = 9.568 \times 10^{-3}$$

$$MV2 = 0 \quad deg2 = 0$$

$$Imax3 = 500 \quad \Delta e3 = -0.017$$

$$MV3 = \begin{pmatrix} 0.53 & -1 \\ -0.428 & 1 \end{pmatrix} \quad deg3 = \begin{pmatrix} 0.03 & 1 \\ -0.037 & -1 \end{pmatrix}$$

$$Imax4 = 5000 \quad \Delta e4 = -6.129 \times 10^{-3}$$

$$MV4 = \begin{pmatrix} 0.124 & 1 \\ -0.156 & -1 \end{pmatrix} \quad deg4 = \begin{pmatrix} 0.074 & -1 \\ -0.06 & 1 \end{pmatrix}$$

$$\frac{\Delta e4 \cdot BC_S1_{2,0}}{MV} = -12.258$$

$$MV5 = \begin{pmatrix} 10.098 & -1 \\ -8.259 & 1 \end{pmatrix} \quad deg5 = \begin{pmatrix} 0.335 & 1 \\ -0.442 & -1 \end{pmatrix}$$

$$\min(\text{stack}(\text{am}, \text{ph})) = 5.805 \times 10^{-4} \quad \min(\text{am}) = 1.036 \times 10^{-3} \quad \min(\text{ph}) = 5.805 \times 10^{-4}$$

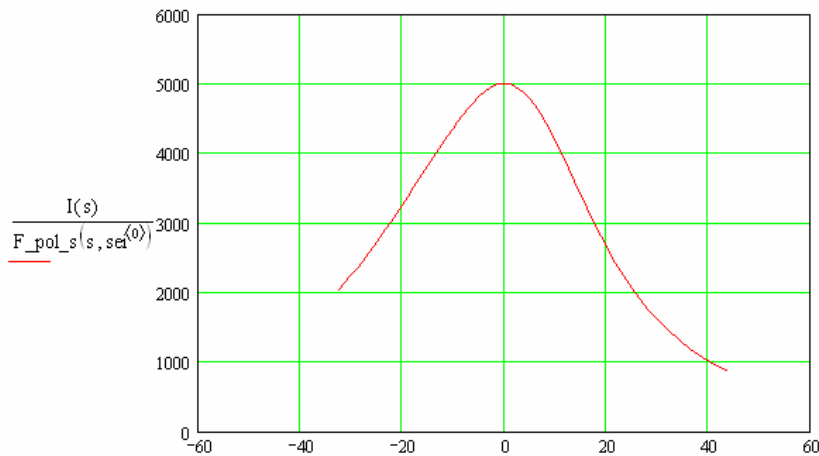
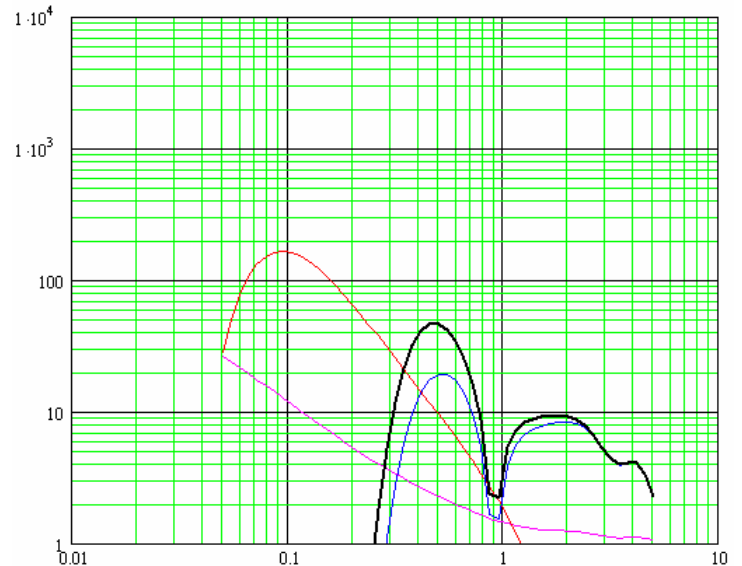

dog+3rd & BC1+3rd & BC2

compression with dog, BC1, BC2
(t566_dog=1.0m)

WRITEPRN("setup.dat") := BC_S1

$$BC_S1 = \begin{pmatrix} 1.3 \times 10^8 & 0.05 & 1.4 \\ 5 \times 10^8 & -0.1 & 8.5714286 \\ 2 \times 10^9 & -0.0333512 & 100 \end{pmatrix}$$

$$\frac{rf^{(0)}}{MV} = \begin{pmatrix} 143.059 \\ 9.816 \\ 433.314 \\ 99.831 \\ 1.596 \times 10^3 \end{pmatrix} \quad \frac{rf^{(1)}}{\text{deg}} = \begin{pmatrix} -12.348 \\ 173.371 \\ -4.671 \\ 128.301 \\ 20 \end{pmatrix}$$

$$QT = \begin{pmatrix} -0.4 & 0 \\ 0.25 & 4.16 \end{pmatrix}$$

$$Imax1 = 50$$

$$MV1 = \begin{pmatrix} 0.063 & -1 \\ -0.042 & 1 \end{pmatrix} \quad \text{deg1} = \begin{pmatrix} 0.151 & 1 \\ -0.221 & -1 \end{pmatrix}$$

$$Imax2 = 70.952 \quad \Delta e2 = 0.014$$

$$MV2 = \begin{pmatrix} 0.045 & 1 \\ -0.056 & -1 \end{pmatrix} \quad \text{deg2} = \begin{pmatrix} 0.393 & -1 \\ -0.319 & 1 \end{pmatrix}$$

$$Imax3 = 606.485 \quad \Delta e3 = -0.015$$

$$MV3 = \begin{pmatrix} 0.436 & -1 \\ -0.352 & 1 \end{pmatrix} \quad \text{deg3} = \begin{pmatrix} 0.039 & 1 \\ -0.048 & -1 \end{pmatrix}$$

$$Imax4 = 5000.424 \quad \Delta e4 = -5.379 \times 10^{-3}$$

$$MV4 = \begin{pmatrix} 0.1 & 1 \\ -0.124 & -1 \end{pmatrix} \quad \text{deg4} = \begin{pmatrix} 0.15 & -1 \\ -0.123 & 1 \end{pmatrix}$$

$$\frac{\Delta e4 \cdot BC_S1_{2,0}}{MV} = -10.758$$

$$MV5 = \begin{pmatrix} 12.303 & -1 \\ -10.067 & 1 \end{pmatrix} \quad \text{deg5} = \begin{pmatrix} 0.436 & 1 \\ -0.555 & -1 \end{pmatrix}$$

$$\min(\text{stack}(\text{am}, \text{ph})) = 3.672 \times 10^{-4} \quad \min(\text{am}) = 3.672 \times 10^{-4} \quad \min(\text{ph}) = 7.63 \times 10^{-4}$$

$$\frac{BC_S1^{(0)}}{MV} = \begin{pmatrix} 130 \\ 500 \\ 2 \times 10^3 \end{pmatrix}$$

$$\frac{BC_S1^{(1)}}{0.001} = \begin{pmatrix} 50 \\ -100 \\ -33.35 \end{pmatrix}$$

$$BC_S1^{(2)} = \begin{pmatrix} 1.4 \\ 8.571 \\ 100 \end{pmatrix}$$

$$\frac{Ene4}{MV} = 1.75 \times 10^4$$

$$\frac{r56_4}{0.001} = 0.84$$

$$C4 = 0.97933$$

$$E_{rms} = 1 \times 10^4$$

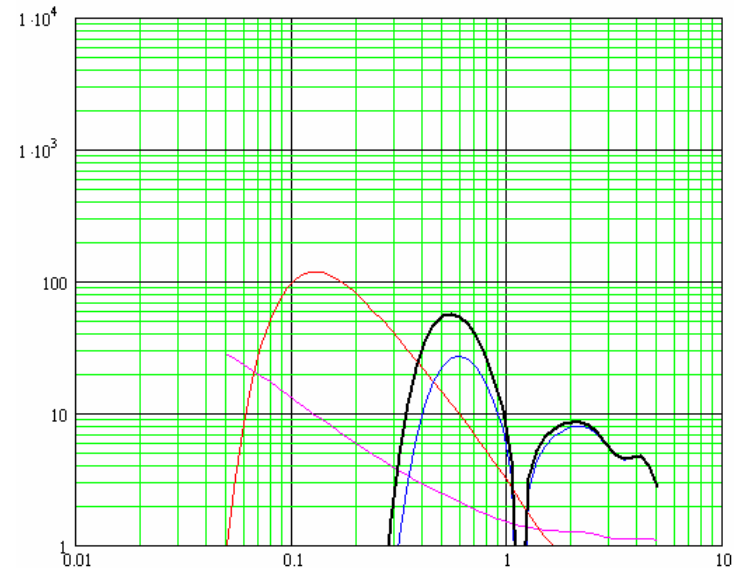

BC0+3rd & BC1+3rd & BC2

compression with BC1 ... BC3

$$BC_S1 = \begin{pmatrix} 1.2 \times 10^8 & -0.15 & 2 \\ 5 \times 10^8 & -0.05 & 5 \\ 2 \times 10^9 & -0.0241987 & 100 \end{pmatrix}$$

$$QT = \begin{pmatrix} 0.078 & 0 \\ 0.909 & 2.4 \end{pmatrix}$$

$$Imax1 = 50$$

$$Imax2 = 100.015 \quad \Delta e2 = -7.979 \times 10^{-3}$$

$$Imax3 = 500.049 \quad \Delta e3 = -0.019$$

$$Imax4 = 5000 \quad \Delta e4 = -8.94 \times 10^{-3}$$

$$\frac{\Delta e4 \cdot BC_S1_{2,0}}{MV} = -17.88$$

$$\min(\text{stack}(\text{am}, \text{ph})) = 1.597 \times 10^{-3}$$

WRITEPRN("setup.dat") := BC_S1

$$\frac{rf^{(0)}}{MV} = \begin{pmatrix} 137.155 \\ 16.174 \\ 505.965 \\ 111.35 \\ 1.958 \times 10^3 \end{pmatrix} \quad \frac{rf^{(1)}}{\text{deg}} = \begin{pmatrix} 6.898 \\ -177.838 \\ 16.831 \\ 159.488 \\ 40 \end{pmatrix}$$

$$MV1 = \begin{pmatrix} 0.808 & -1 \\ -1.024 & -1 \end{pmatrix} \quad \text{deg1} = \begin{pmatrix} 0.082 & 1 \\ -0.101 & -1 \end{pmatrix}$$

$$MV2 = \begin{pmatrix} 0.917 & -1 \\ -0.725 & -1 \end{pmatrix} \quad \text{deg2} = \begin{pmatrix} 0.289 & -1 \\ -0.236 & 1 \end{pmatrix}$$

$$MV3 = \begin{pmatrix} 1.822 & -1 \\ -1.455 & 1 \end{pmatrix} \quad \text{deg3} = \begin{pmatrix} 0.086 & 1 \\ -0.106 & -1 \end{pmatrix}$$

$$MV4 = \begin{pmatrix} 0.479 & 1 \\ -0.591 & -1 \end{pmatrix} \quad \text{deg4} = \begin{pmatrix} 0.24 & -1 \\ -0.197 & 1 \end{pmatrix}$$

$$MV5 = \begin{pmatrix} 13.485 & -1 \\ -11.083 & 1 \end{pmatrix} \quad \text{deg5} = \begin{pmatrix} 0.209 & 1 \\ -0.313 & -1 \end{pmatrix}$$

$$\min(\text{am}) = 3.239 \times 10^{-3} \quad \min(\text{ph}) = 1.597 \times 10^{-3}$$

+

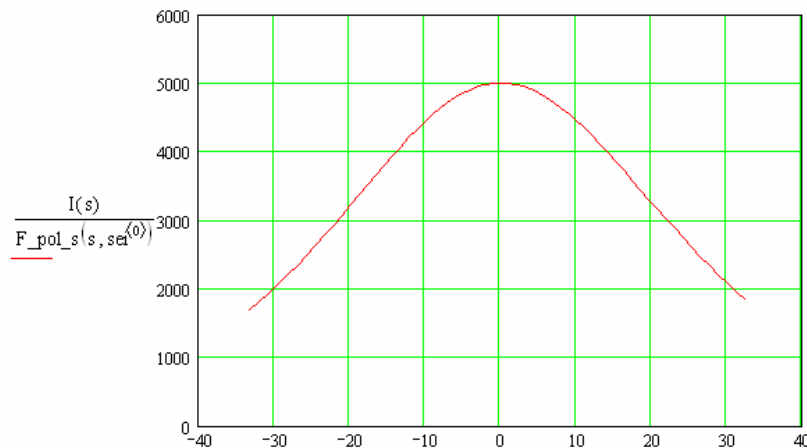

$$\frac{BC_S1^{(0)}}{MV} = \begin{pmatrix} 120 \\ 500 \\ 2 \times 10^3 \end{pmatrix} \quad \frac{BC_S1^{(1)}}{0.001} = \begin{pmatrix} -150 \\ -50 \\ -24.2 \end{pmatrix} \quad BC_S1^{(2)} = \begin{pmatrix} 2 \\ 5 \\ 100 \end{pmatrix}$$

$$\frac{E_{ne4}}{MV} = 1.75 \times 10^4$$

$$\frac{r56_4}{0.001} = 0.84$$

$$C4 = 0.96553$$

$$E_{rms} = 1 \times 10^4$$

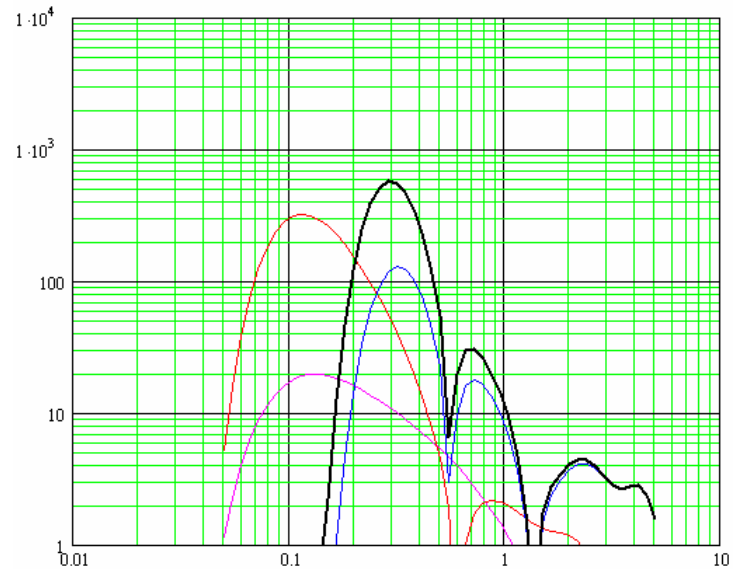

different r56 in collimator

$$\frac{BC_S1^{(0)}}{MV} = \begin{pmatrix} 120 \\ 500 \\ 2 \times 10^3 \end{pmatrix} \quad \frac{BC_S1^{(1)}}{0.001} = \begin{pmatrix} -150 \\ -50 \\ -24.2 \end{pmatrix} \quad BC_S1^{(2)} = \begin{pmatrix} 2 \\ 5 \\ 100 \end{pmatrix}$$

$$\frac{Ene4}{MV} = 1.75 \times 10^4 \quad \frac{r56_4}{0.001} = 0.4 \quad C4 = 0.98328$$

$$E_{rms} = 1 \times 10^4$$

$$\frac{BC_S1^{(0)}}{MV} = \begin{pmatrix} 120 \\ 500 \\ 2 \times 10^3 \end{pmatrix} \quad \frac{BC_S1^{(1)}}{0.001} = \begin{pmatrix} -150 \\ -50 \\ -24.2 \end{pmatrix} \quad BC_S1^{(2)} = \begin{pmatrix} 2 \\ 5 \\ 100 \end{pmatrix}$$

$$\frac{Ene4}{MV} = 1.75 \times 10^4 \quad \frac{r56_4}{0.001} = 0.84 \quad C4 = 0.96553$$

$$E_{rms} = 1 \times 10^4$$

$$\frac{BC_S1^{(0)}}{MV} = \begin{pmatrix} 120 \\ 500 \\ 2 \times 10^3 \end{pmatrix} \quad \frac{BC_S1^{(1)}}{0.001} = \begin{pmatrix} -150 \\ -50 \\ -24.2 \end{pmatrix} \quad BC_S1^{(2)} = \begin{pmatrix} 2 \\ 5 \\ 100 \end{pmatrix}$$

$$\frac{Ene4}{MV} = 1.75 \times 10^4 \quad \frac{r56_4}{0.001} = -0.4 \quad C4 = 1.0173$$

$$E_{rms} = 1 \times 10^4$$

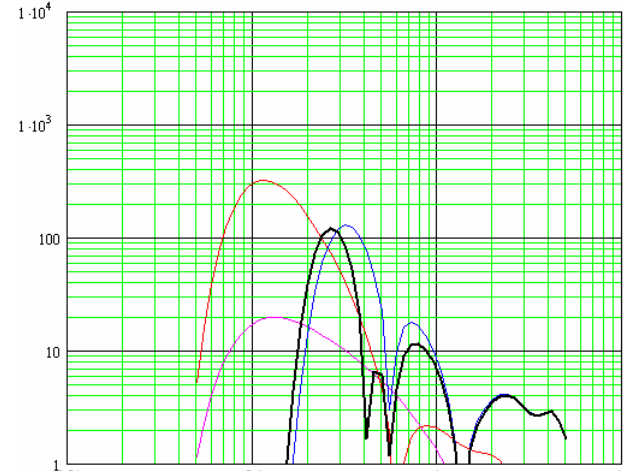
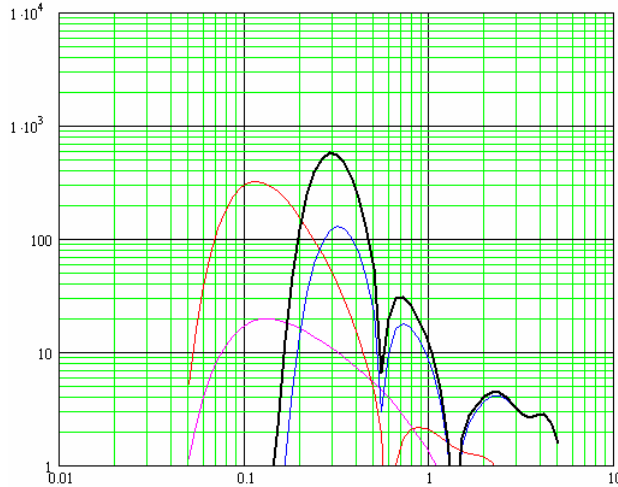
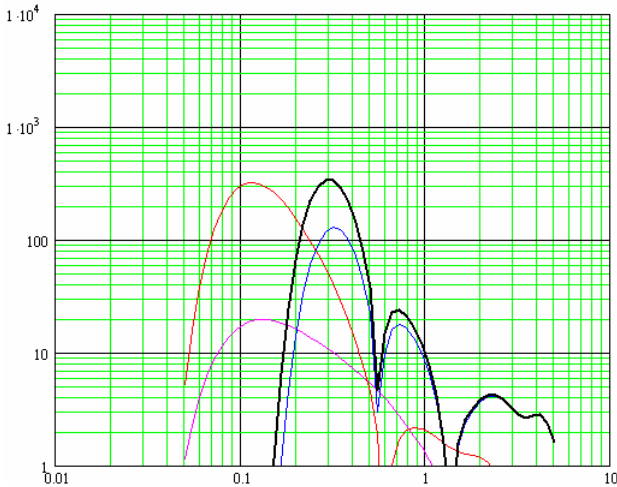

$$\frac{BC_S1^{(0)}}{MV} = \begin{pmatrix} 120 \\ 500 \\ 2 \times 10^3 \end{pmatrix} \quad \frac{BC_S1^{(1)}}{0.001} = \begin{pmatrix} -150 \\ -50 \\ -24.2 \end{pmatrix} \quad BC_S1^{(2)} = \begin{pmatrix} 2 \\ 5 \\ 100 \end{pmatrix}$$

$$\frac{Ene4}{MV} = 1.75 \times 10^4 \quad \frac{r56_4}{0.001} = -0.2 \quad C4 = 1.00857$$

$$E_{rms} = 1 \times 10^4$$

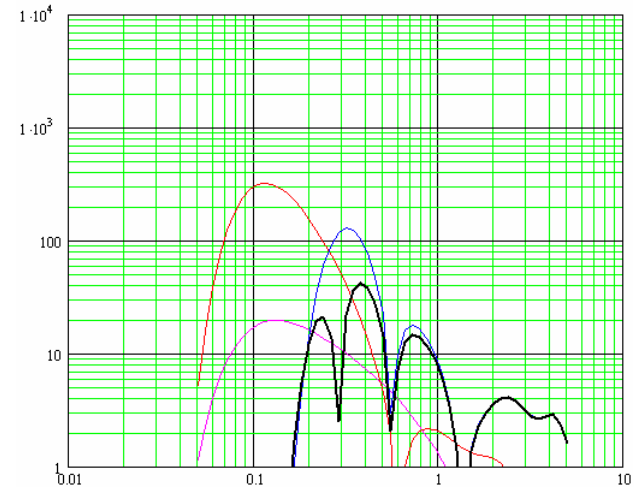

new (induced) modulation with opposite sign of original modulation

$$E(s) := E_0 + E_0 s \cdot s + \operatorname{Re} \left[\overline{Z(k)} \cdot (I_1 \cdot \exp(i \cdot k \cdot s)) \right]$$

$$C(s) := \frac{1}{1 - \frac{r56}{E_0} \frac{d}{ds} E(s)}$$

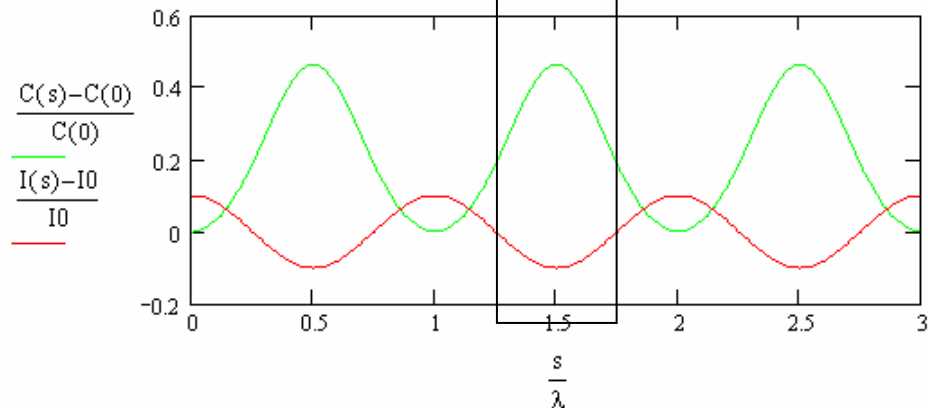
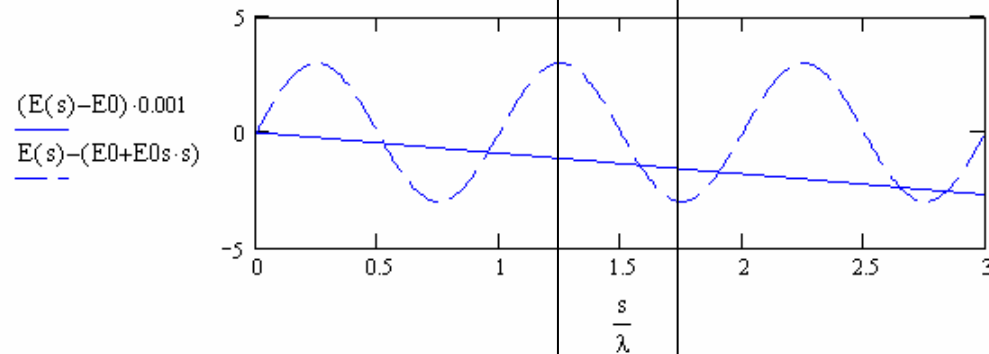
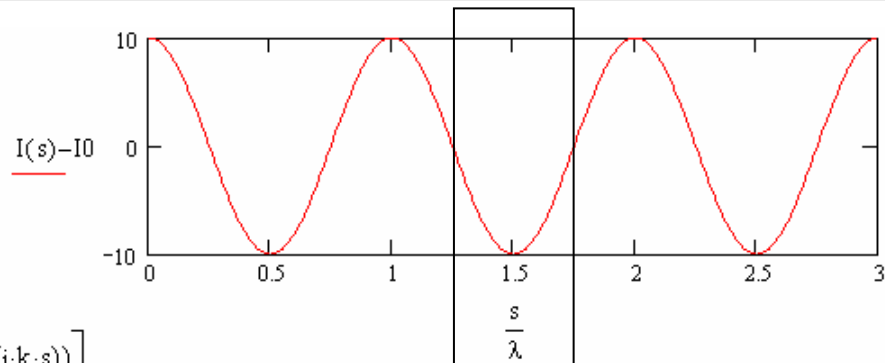

75A-Gun, BC0+3rd & BC1+3rd & BC2

compression with BC1 ... BC3

WRITEPRN("setup.dat") := BC_S1

$$BC_S1 = \begin{pmatrix} 1.2 \times 10^8 & -0.15 & 2 \\ 5 \times 10^8 & -0.05 & 5 \\ 2 \times 10^9 & -0.0228544 & 66.6666667 \end{pmatrix}$$

$$\frac{rf^{(0)}}{MV} = \begin{pmatrix} 137.194 \\ 16.213 \\ 505.292 \\ 110.691 \\ 1.958 \times 10^3 \end{pmatrix} \quad \frac{rf^{(1)}}{\text{deg}} = \begin{pmatrix} 6.896 \\ -177.843 \\ 16.855 \\ 159.36 \\ 40 \end{pmatrix}$$

$$QT = \begin{pmatrix} 0.08 & 0 \\ 0.897 & 2.4 \end{pmatrix}$$

Imax1 = 75

$$MV1 = \begin{pmatrix} 0.942 & -1 \\ -1.111 & -1 \end{pmatrix} \quad \text{deg1} = \begin{pmatrix} 0.113 & 1 \\ -0.138 & -1 \end{pmatrix}$$

Imax2 = 150.012 $\Delta e2 = -5.319 \times 10^{-3}$

$$MV2 = \begin{pmatrix} 1.075 & -1 \\ -0.897 & -1 \end{pmatrix} \quad \text{deg2} = \begin{pmatrix} 0.395 & -1 \\ -0.323 & 1 \end{pmatrix}$$

Imax3 = 750.034 $\Delta e3 = -0.013$

$$MV3 = \begin{pmatrix} 2.45 & -1 \\ -1.96 & 1 \end{pmatrix} \quad \text{deg3} = \begin{pmatrix} 0.124 & 1 \\ -0.153 & -1 \end{pmatrix}$$

Imax4 = 5000 $\Delta e4 = -5.946 \times 10^{-3}$

$$MV4 = \begin{pmatrix} 0.68 & 1 \\ -0.841 & -1 \end{pmatrix} \quad \text{deg4} = \begin{pmatrix} 0.357 & -1 \\ -0.294 & 1 \end{pmatrix}$$

$$\frac{\Delta e4 \cdot BC_S1_{2,0}}{MV} = -11.892$$

$$MV5 = \begin{pmatrix} 21.345 & -1 \\ -17.659 & 1 \end{pmatrix} \quad \text{deg5} = \begin{pmatrix} 0.362 & 1 \\ -0.467 & -1 \end{pmatrix}$$

$\min(\text{stack}(\text{am}, \text{ph})) = 2.188 \times 10^{-3}$

$\min(\text{am}) = 4.364 \times 10^{-3}$ $\min(\text{ph}) = 2.188 \times 10^{-3}$

$$\frac{BC_S1^{(0)}}{MV} = \begin{pmatrix} 120 \\ 500 \\ 2 \times 10^3 \end{pmatrix} \quad \frac{BC_S1^{(1)}}{0.001} = \begin{pmatrix} -150 \\ -50 \\ -22.85 \end{pmatrix} \quad BC_S1^{(2)} = \begin{pmatrix} 2 \\ 5 \\ 66.67 \end{pmatrix}$$

$$\frac{Ene4}{MV} = 1.75 \times 10^4$$

$$\frac{e56_4}{0.001} = 0.84$$

$$C4 = 0.97674$$

$$E_{rms} = 1.5 \times 10^4$$

$$E_{rms} * C_{tot} = 1 \text{ MeV} = \text{const}$$

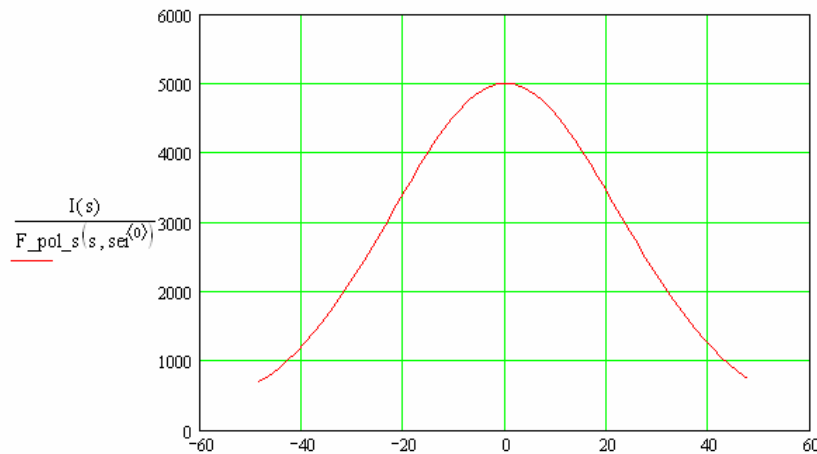
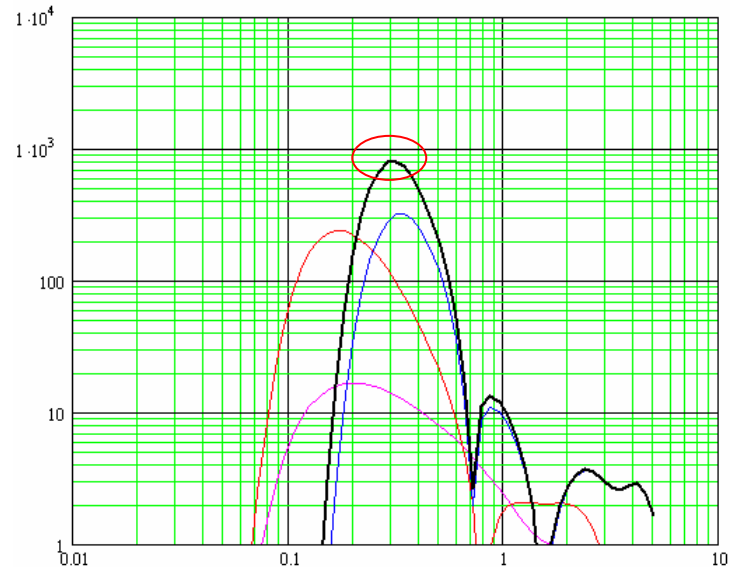

$$\frac{BC_S1^{(0)}}{MV} = \begin{pmatrix} 120 \\ 500 \\ 2 \times 10^3 \end{pmatrix} \quad \frac{BC_S1^{(1)}}{0.001} = \begin{pmatrix} -150 \\ -50 \\ -22.85 \end{pmatrix} \quad BC_S1^{(2)} = \begin{pmatrix} 2 \\ 5 \\ 66.67 \end{pmatrix}$$

$$\frac{E_{ne4}}{MV} = 1.75 \times 10^4 \quad \frac{r56_4}{0.001} = 0.84 \quad C4 = 0.97674$$

$$E_{rms} = 2.25 \times 10^4 \quad E_{rms} * C_{tot} = 1.5MeV$$

